

T1 Bitte unbedingt ausfüllen!

Name _____

Strasse _____

Plz _____ Ort _____

Tel. _____

T2 Sehr geehrte Kunden, wir freuen uns, dass Sie sich für ein Produkt aus dem Hause Pelipal entschieden haben. Sollte es trotz aller Bemühungen unsererseits, Ihnen ein qualitativ hochwertiges Möbelstück zu liefern, zu Fehlteilen kommen, schicken Sie bitte dieses ausgefüllte Blatt an

Fax.: **+49 3443/434354**

E-Mail: ***weissenfels.ersatzteile@pelipal.de***

Bitte beachten Sie, dass Bauteile über 800mm Länge und 350mm Breite direkt bei Ihrem Möbelhändler zu beanstanden sind. Zur Reklamationsbearbeitung ist es unbedingt erforderlich **die Artikelnummer des Schrankes**, welche auf dem Etikett ersichtlich ist und den Markt, wo das Möbel erworben wurde anzugeben. Außerdem tragen Sie unten bitte die benötigte Stückzahl ein. Viel Spaß mit Ihrem neuen Badmöbel! Ihr Pelipal Team

_____ - _____

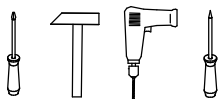

T3 Für den Zusammenbau sind 2 Personen erforderlich.

T4 Montage-Richtzeit 3 Stunden

8 x a DUEB-SMD-000005	Stück	8 x b EXZENTER-000015	Stück	2 x c RWD-KEI-000060	Stück	1 x f 1 x g 			
2 x d ZPL-003X006	Stück	2 x e TBD-35-115X17	Stück	1 x j AUF-001-000080	Stück	1 x h 			
1 x k AUF-001-000090	Stück	12 x l SCH-SPA-035X015	Stück	4 x m 6.3 x 16 SCH-KA-063X016	Stück	1 x i KA-SZ-270X085			
5 x n 1.4 x 25 NAGEL-025X001	Stück	2 x o 5 x 8 ADK-AL1-005X008	Stück	2 x p Griff	Stück	4 x q Stück	10 x r SCH-RDK-035X015	Stück	
2 x s AUF-001-000020	Stück	4 x t TRAE-001-000020	Stück	1 x v TUER-DAEM-000010	Stück	1 x w TUER-ADA-000010	Stück	4 x x DTS-20X4X6,5	Stück

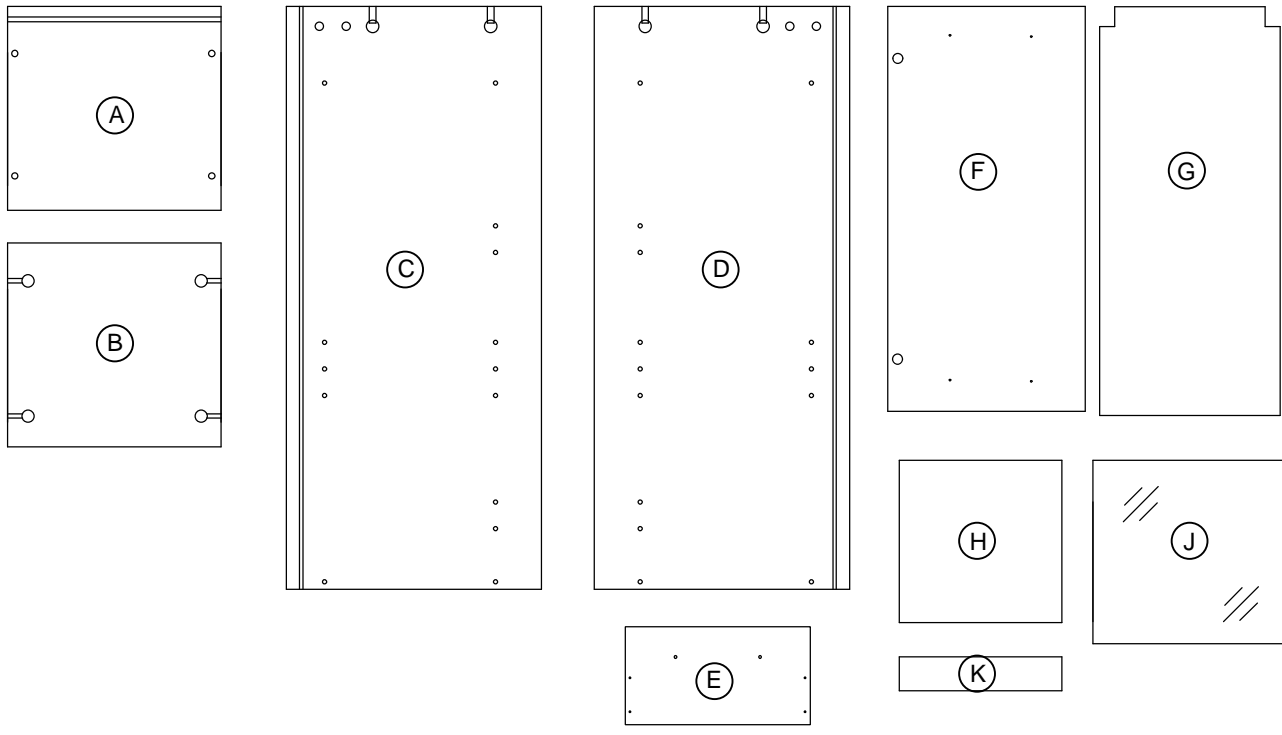

1.

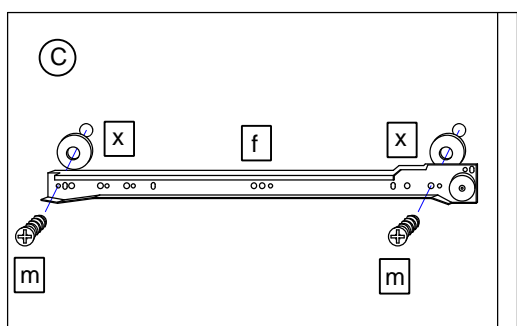
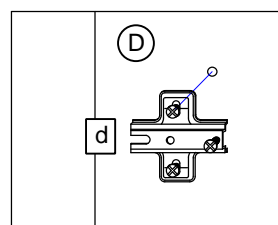
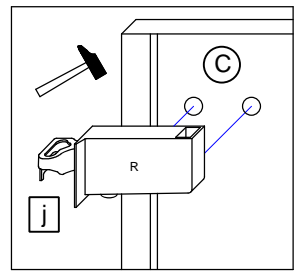
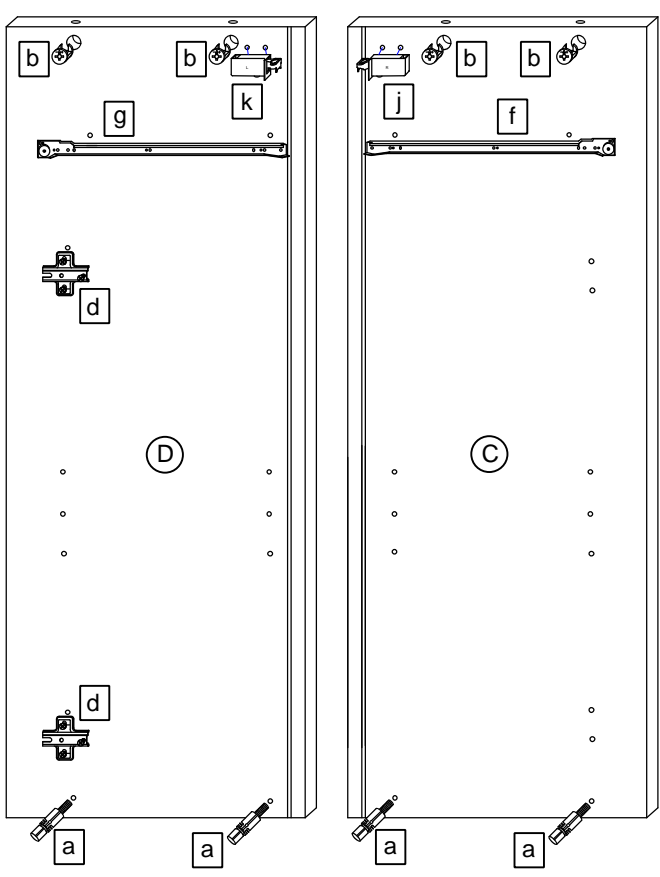
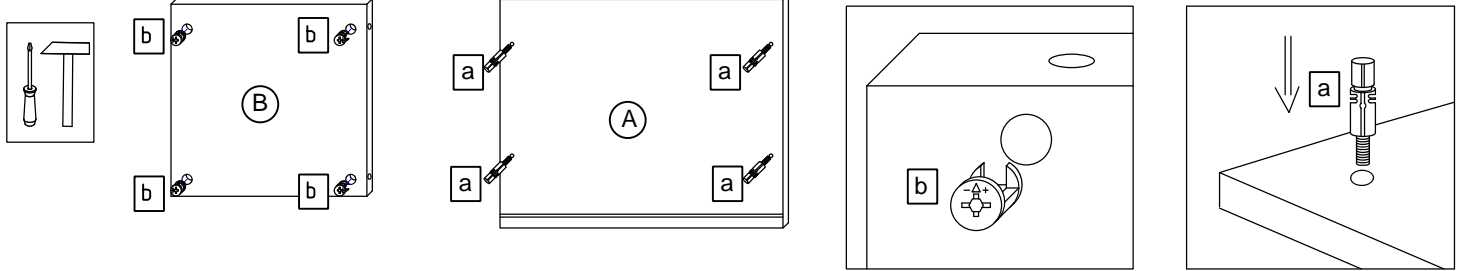

2.

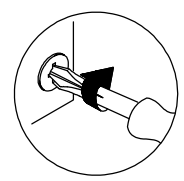
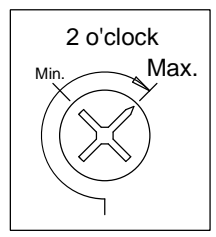
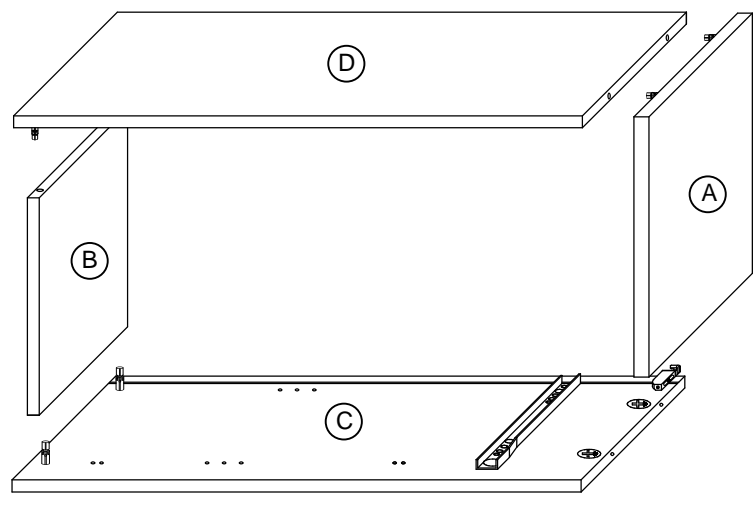
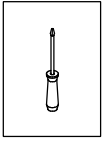

3.

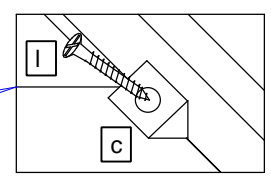
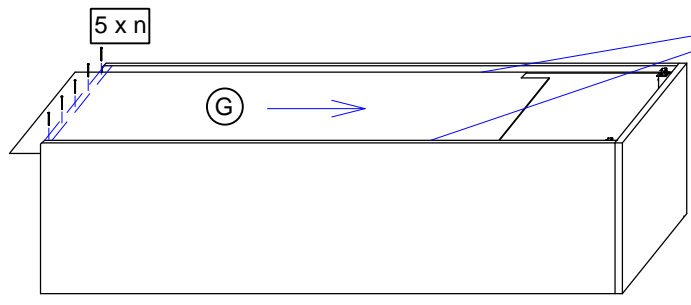
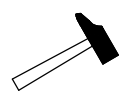
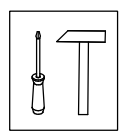

4.

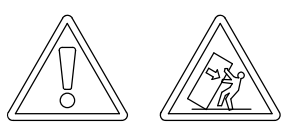
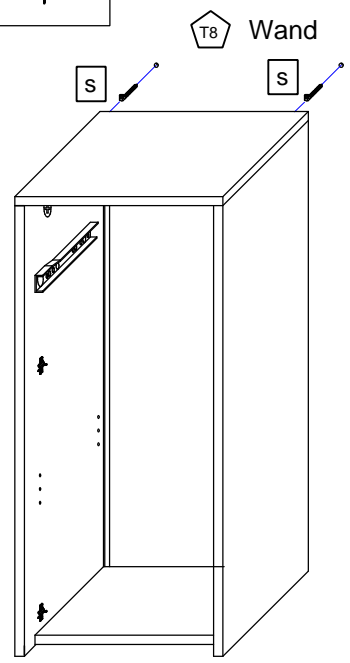
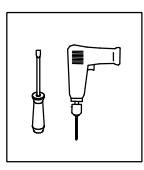

T6 Die Schrankaufhänger dienen zur Kippsicherung des Schrankes und müssen grundsätzlich montiert werden.

T9 Lassen Sie den Schrank nur durch fachkundige Personen mit für die Wand geeignetem Montagematerialien montieren.

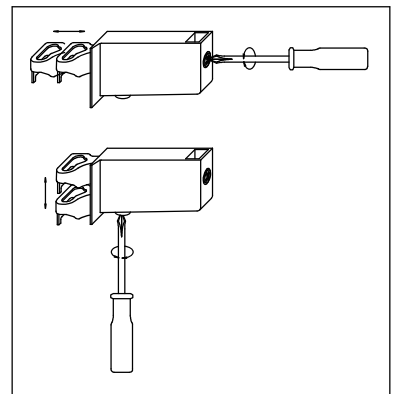
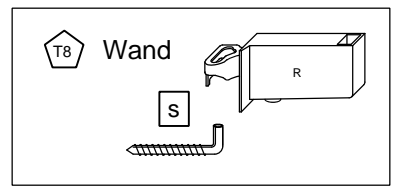

T5 Das Etikett, welches sich unten rechts befindet bitte ausschneiden und auf der Rückwand mit Klebeband (nicht beiliegend) befestigen.

PELIPAL GmbH
 Hans-Wilhelm-Peters-Straße 2
 33189 Schlangen
 Germany

5.

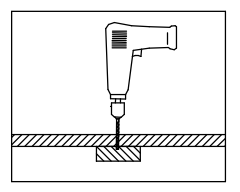
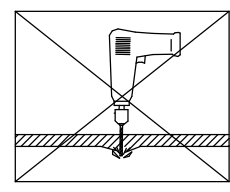
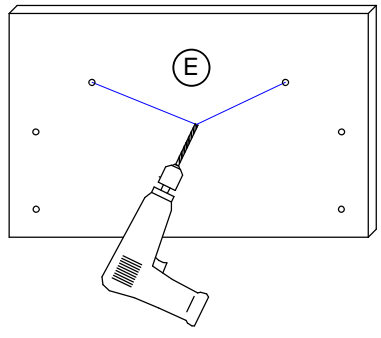
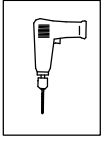

6.

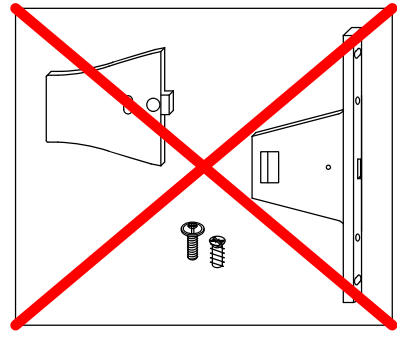
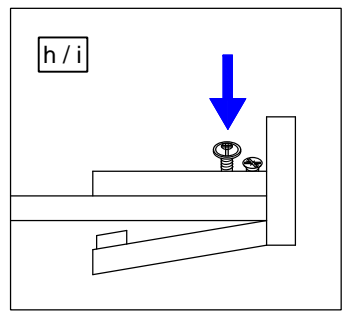
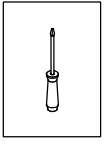

6.1

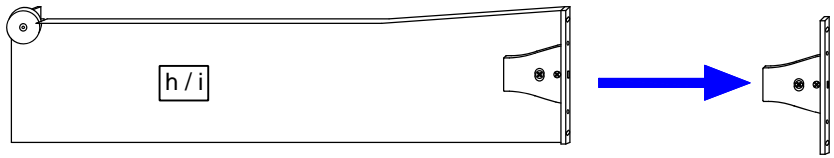

6.2

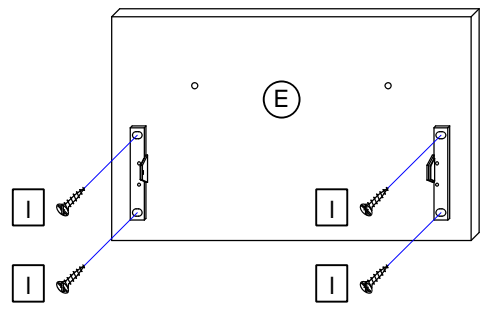

7.

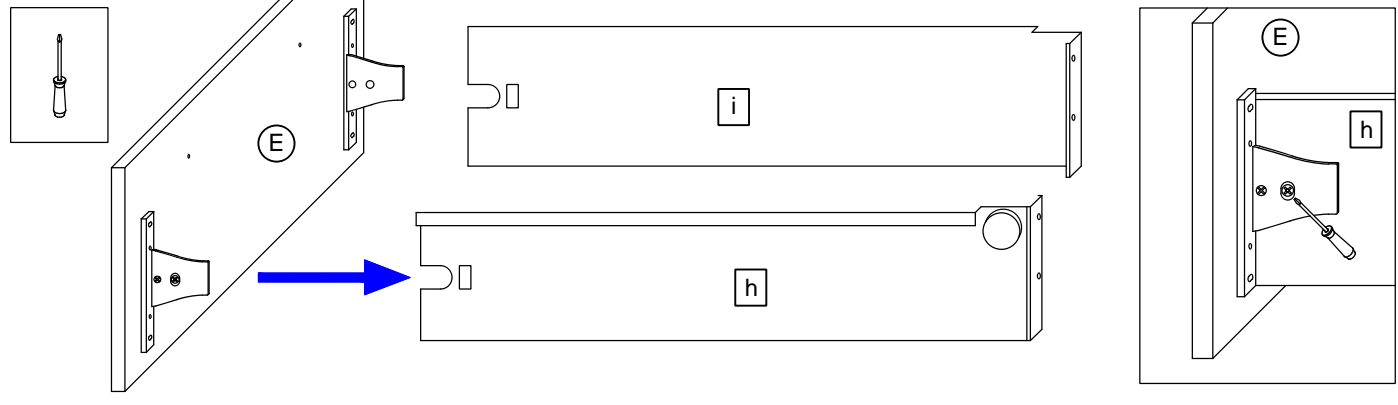

8.

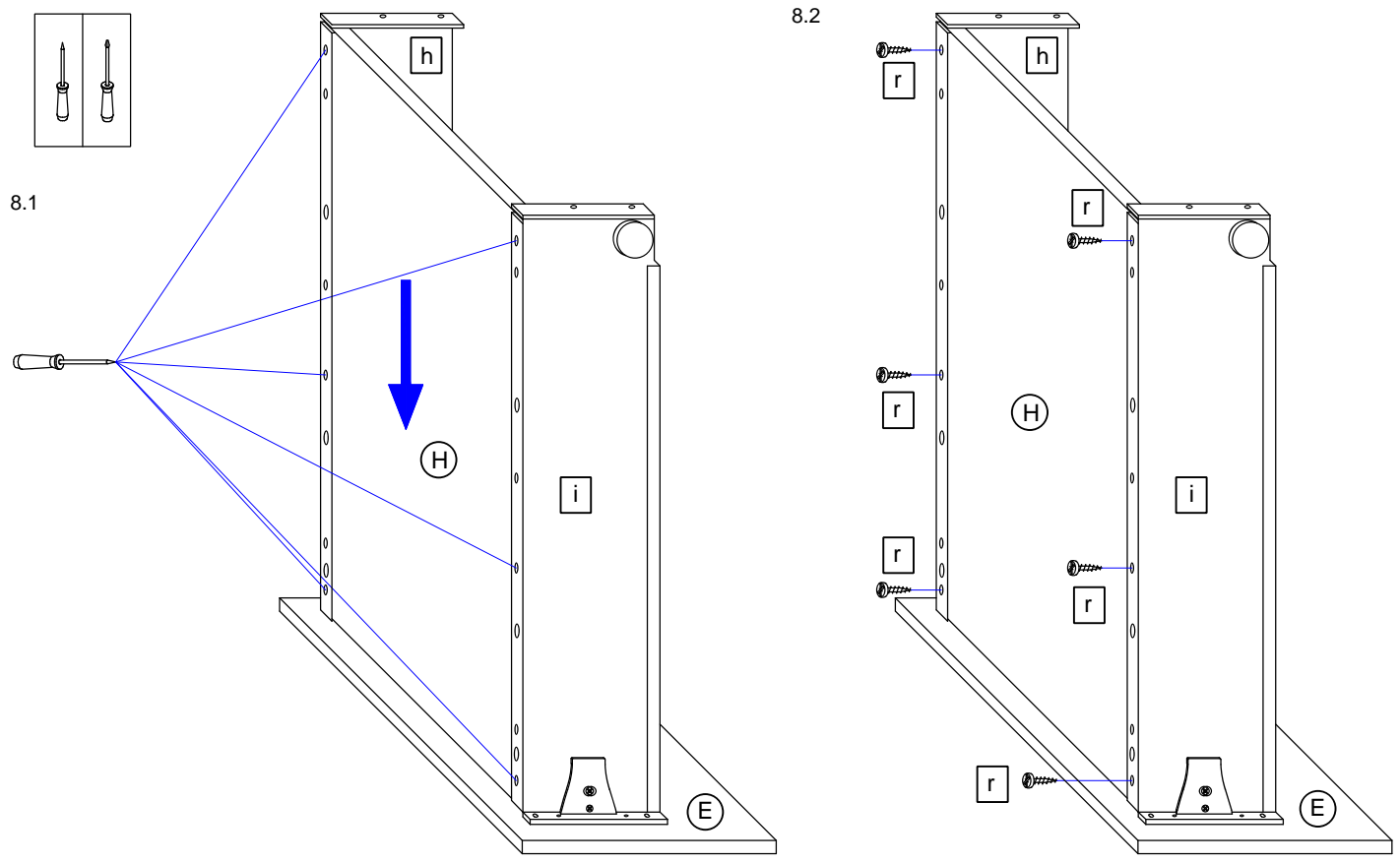

9.

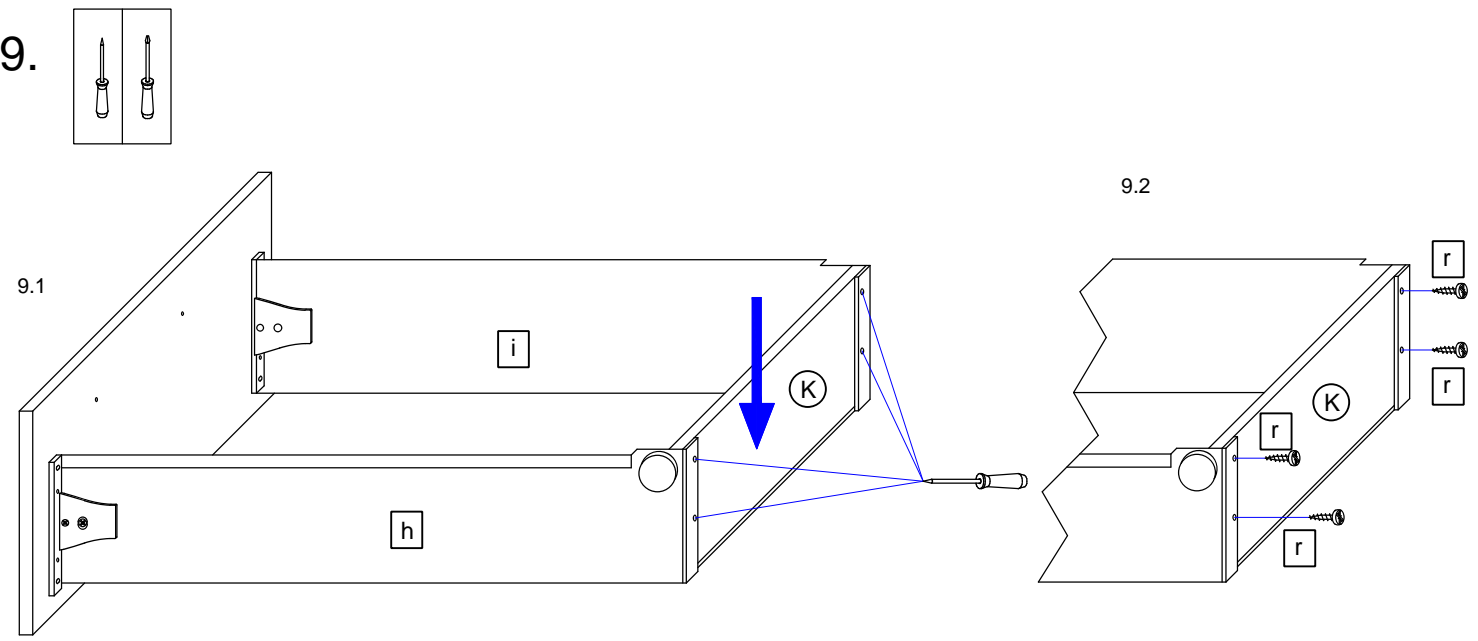

10.

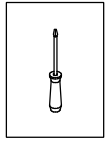

10.1

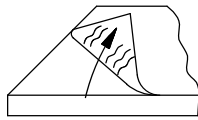

10.2

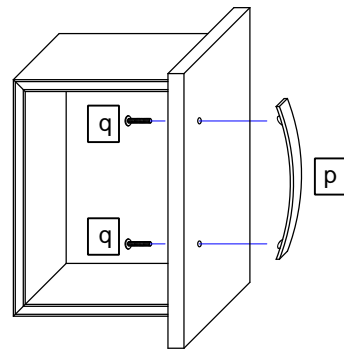

Bei Hochglanz-Fronten bitte erst die Schutzfolie entfernen und dann den Griff montieren!

11.

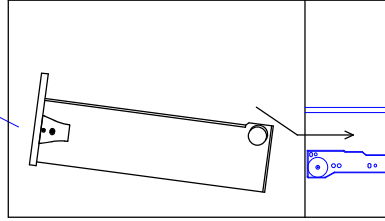
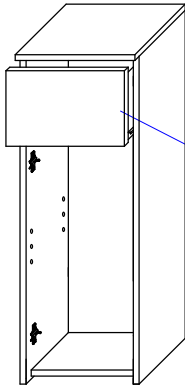

12.

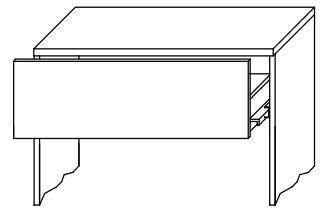
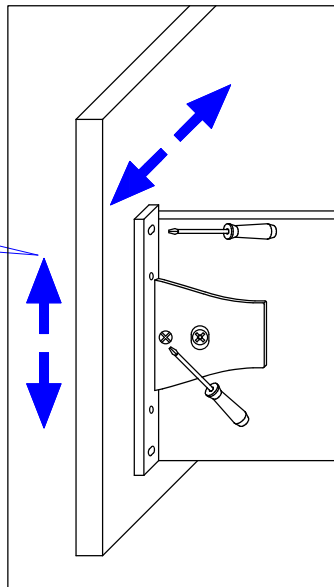
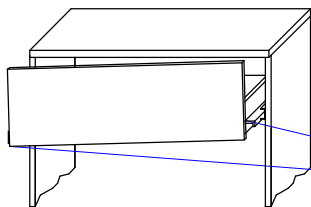
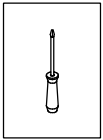

13.

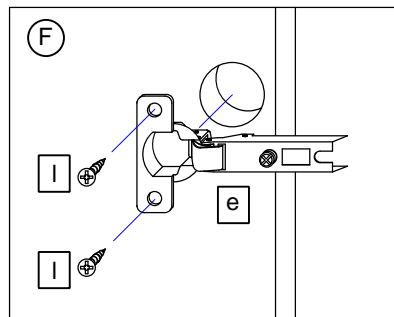
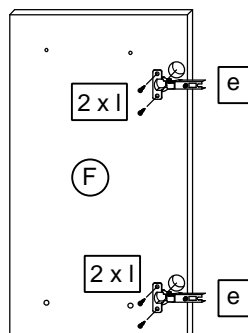
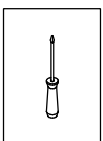

14.

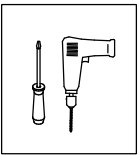

14.1

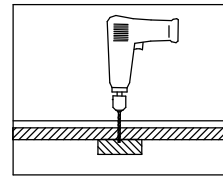
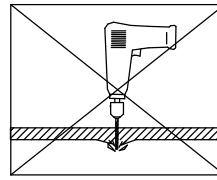

14.2

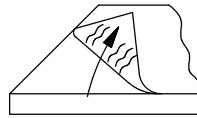

T10

Bei Hochglanz-Fronten bitte erst die Schutzfolie entfernen und dann den Griff montieren!

14.3

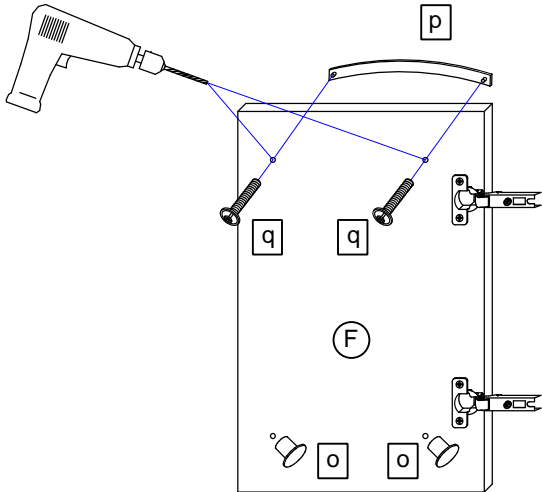
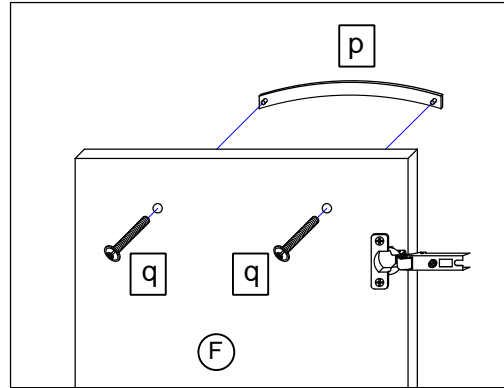

15.

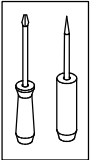

T11

Bei Türmontage das Scharnier einhängen, bis Anschlag öffnen und anschließend festschrauben.

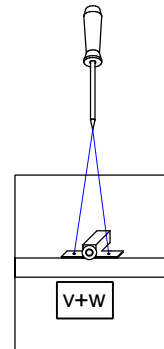
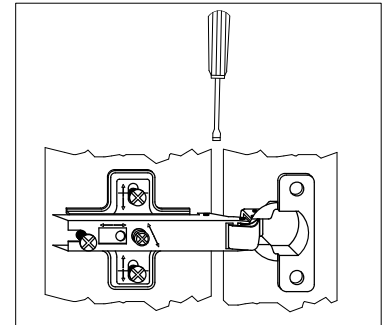
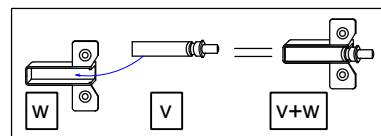
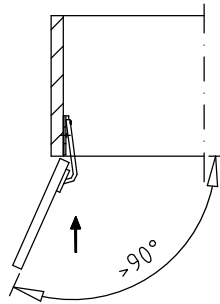
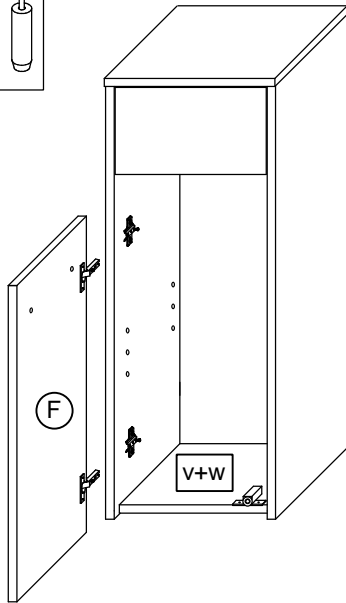

2 x 1
(3,5x15)

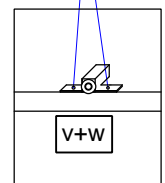

16.

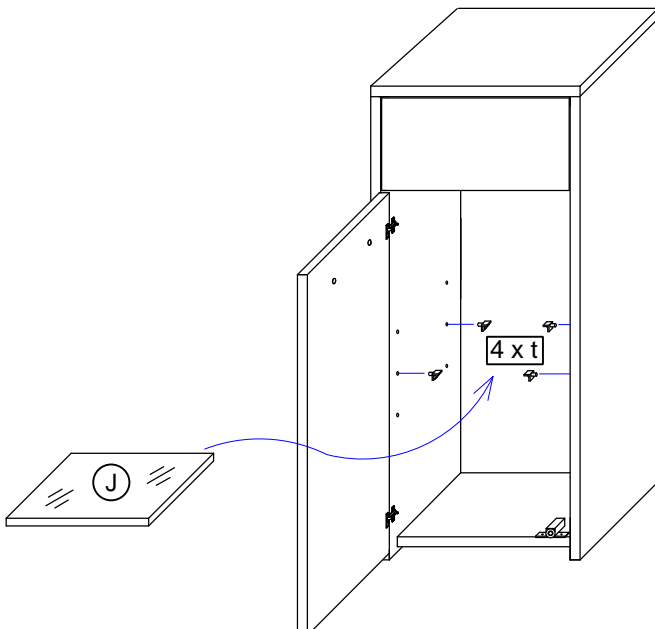

T12

Das Möbel bitte nur mit einem feuchten Tuch reinigen.