

1/2				
	H	B	T	
1	736	337	16	x1
7	736	327	16	x1
4	769	380	22	x1
6	769	380	22	x1

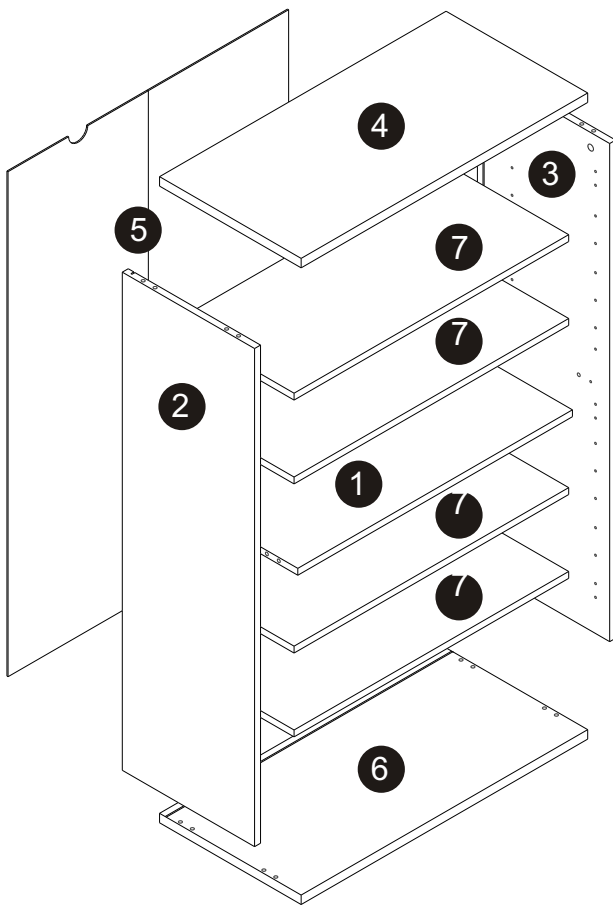

1/2				
	H	B	T	
2	1158	355	16	x1
3	1158	355	16	x1
5	1174	754	3	x1
8	384	380	16	x1
9	384	380	16	x1
10	384	380	16	x1
11	384	380	16	x1
12	384	380	16	x1
13	384	380	16	x1

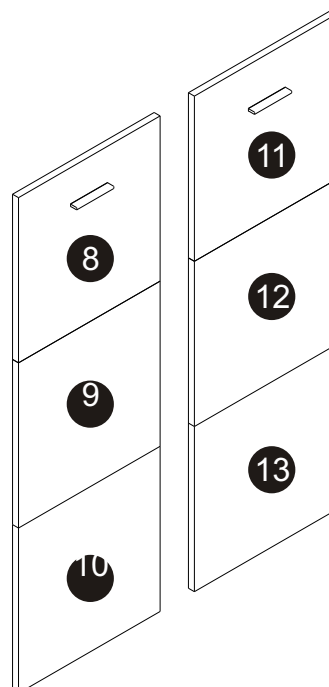

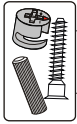

1/2

ZM1 16	ZM1 8	K1 4	KD1 12	KK1 1	W1 4
W4 12	ZP 6	Z1P 6	PP 16	W6 4	SS3 4
ZM1A 24	ZM1B 8	W11 2	S1 10	KS1 1	KRW1 1
KD2 12	TPP1 8	U99 2	WU 4		

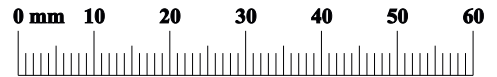

01

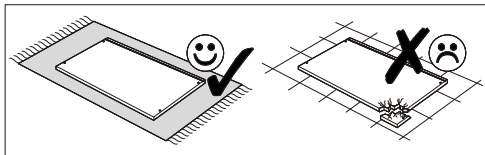

ZM1A 4	KD1 4

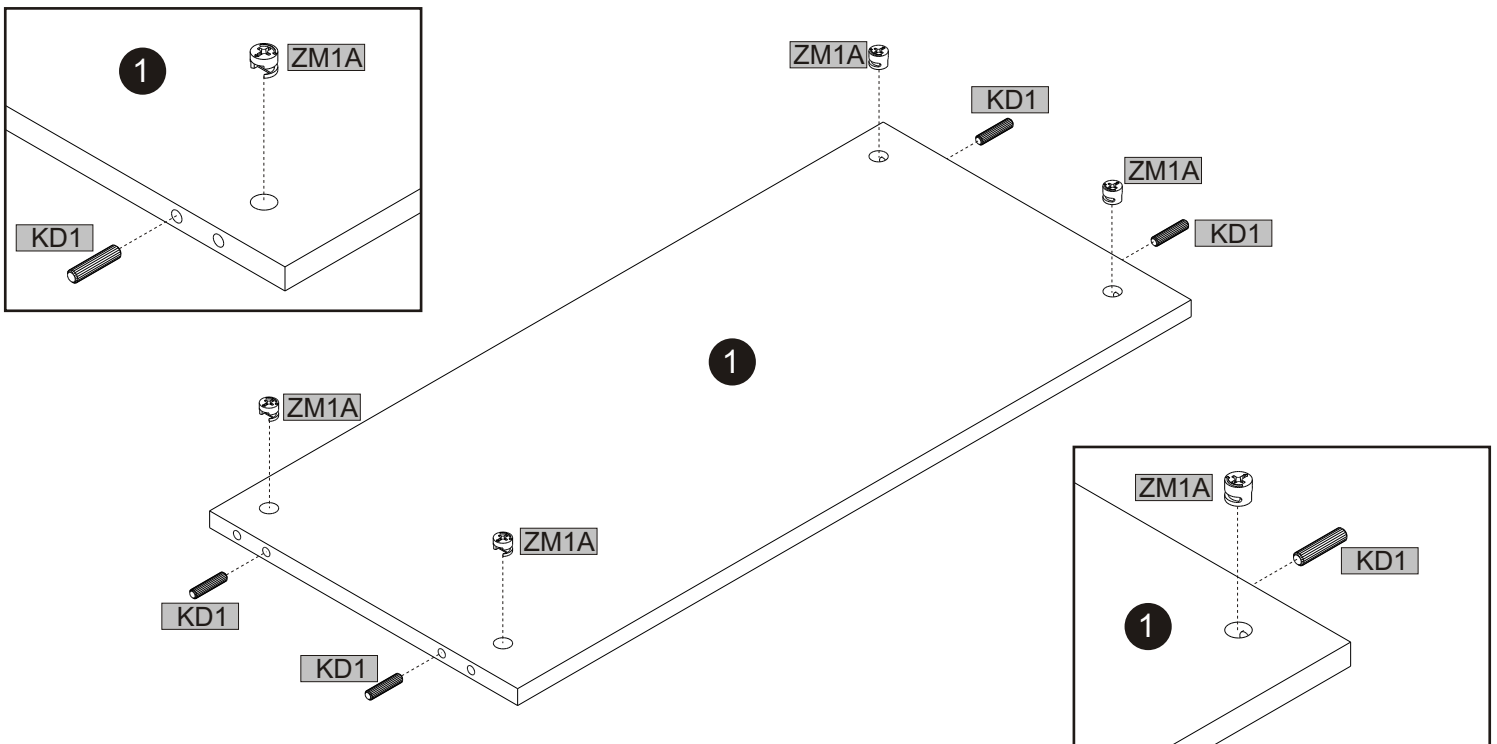

02

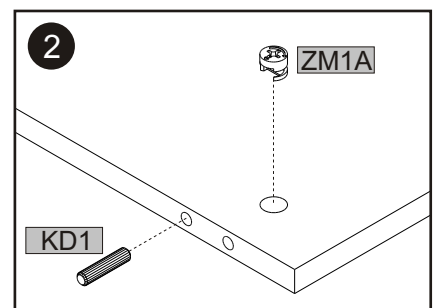
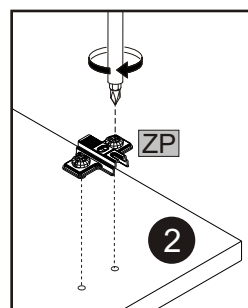
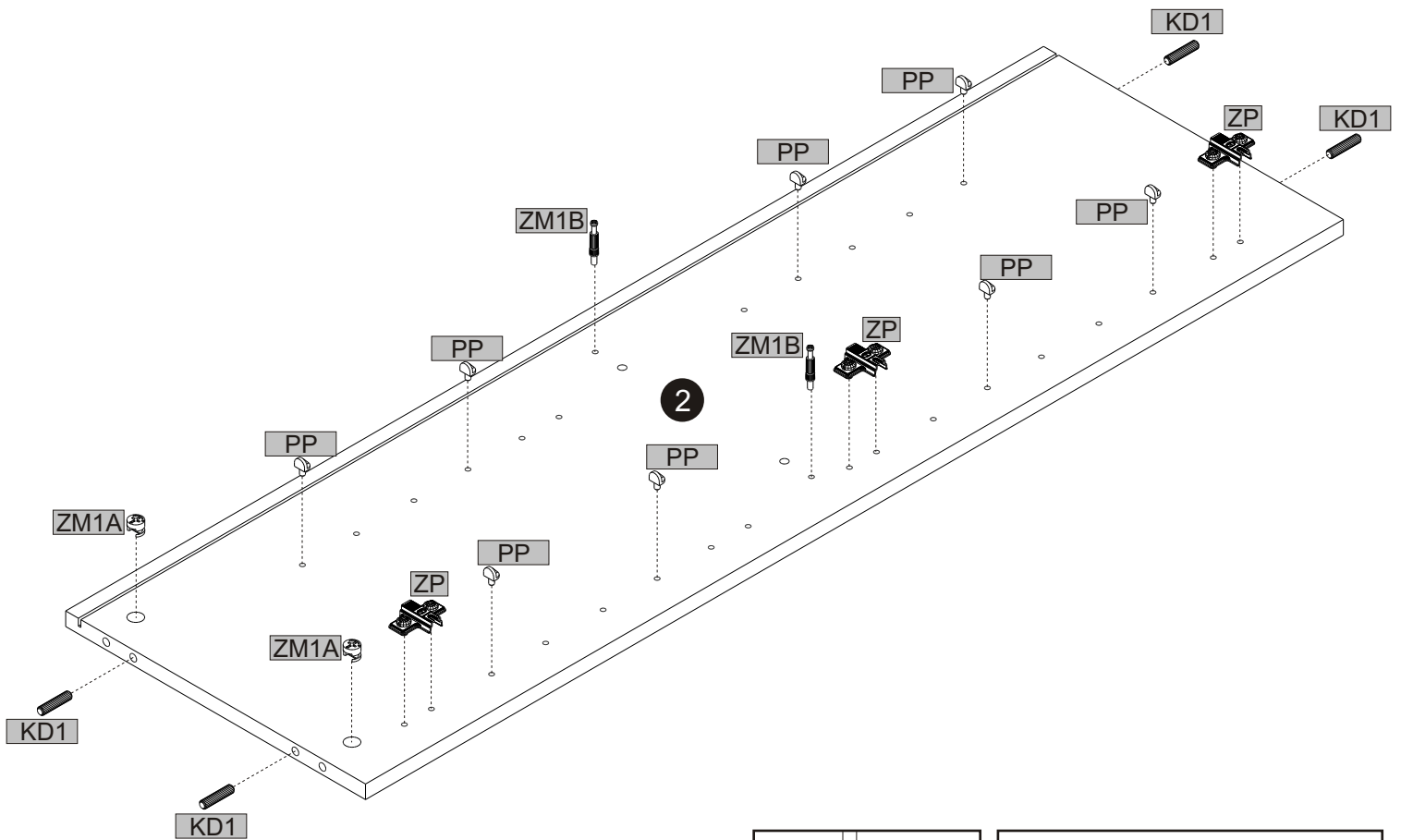
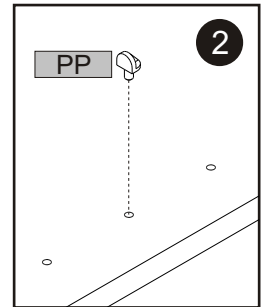
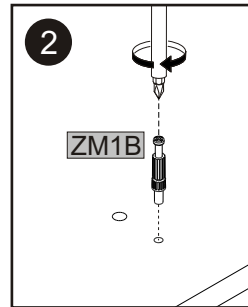
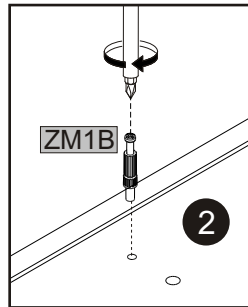
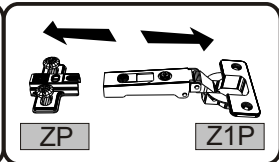
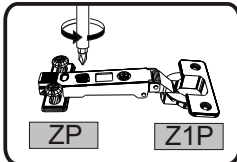
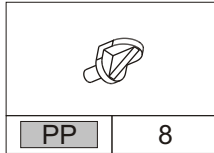
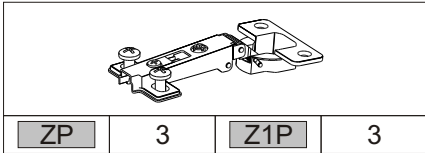
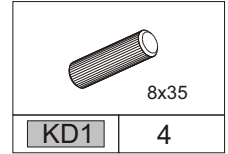
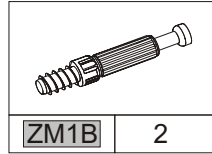
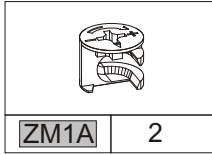
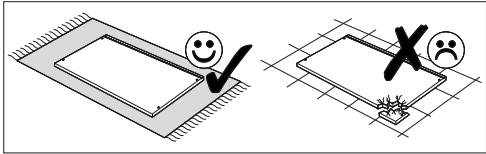

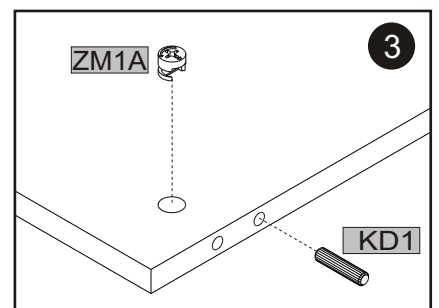
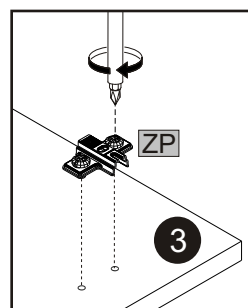
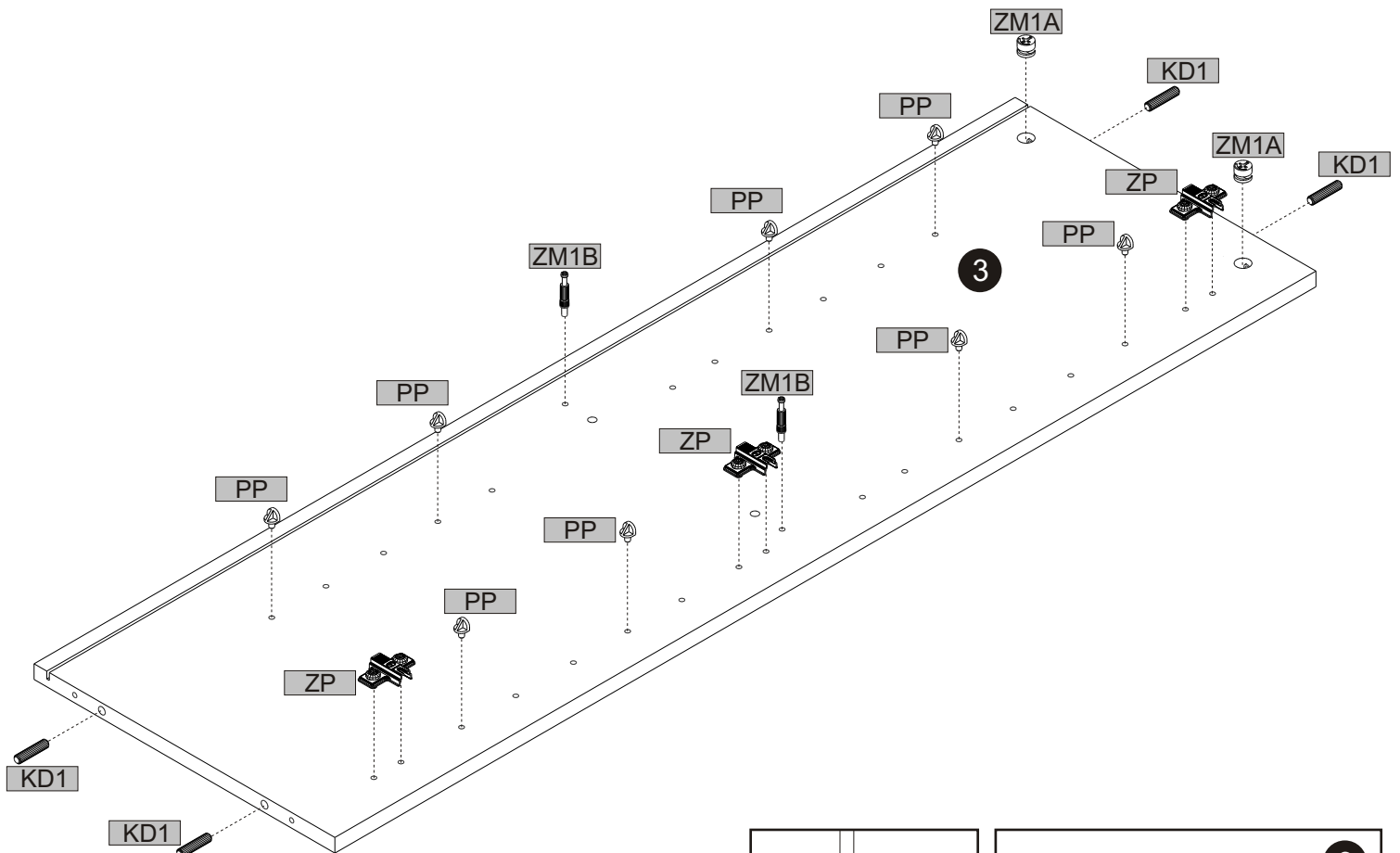
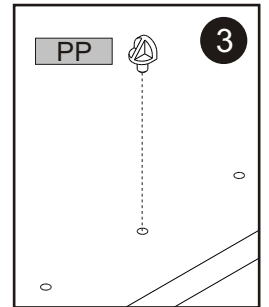
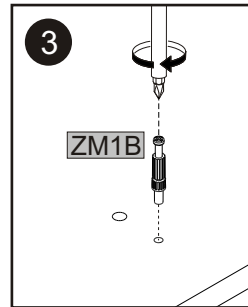
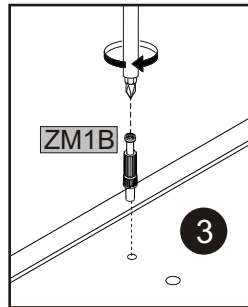
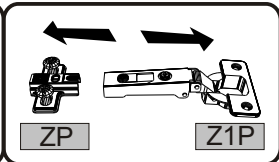
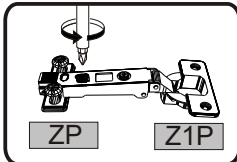
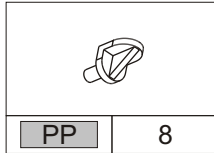
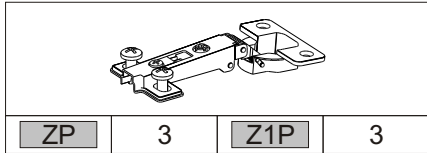
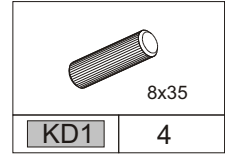
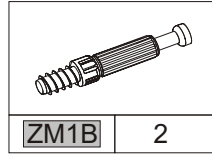
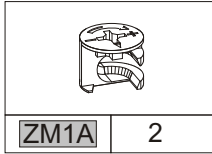
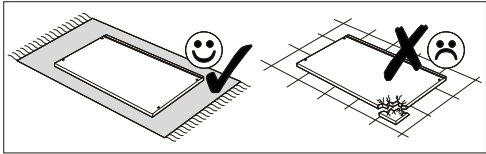

03

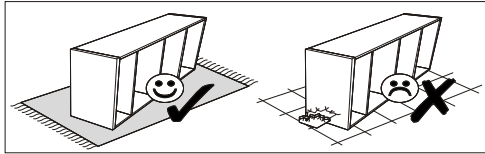

04

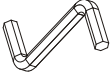

	1		4
KK1	1	ZM1	4

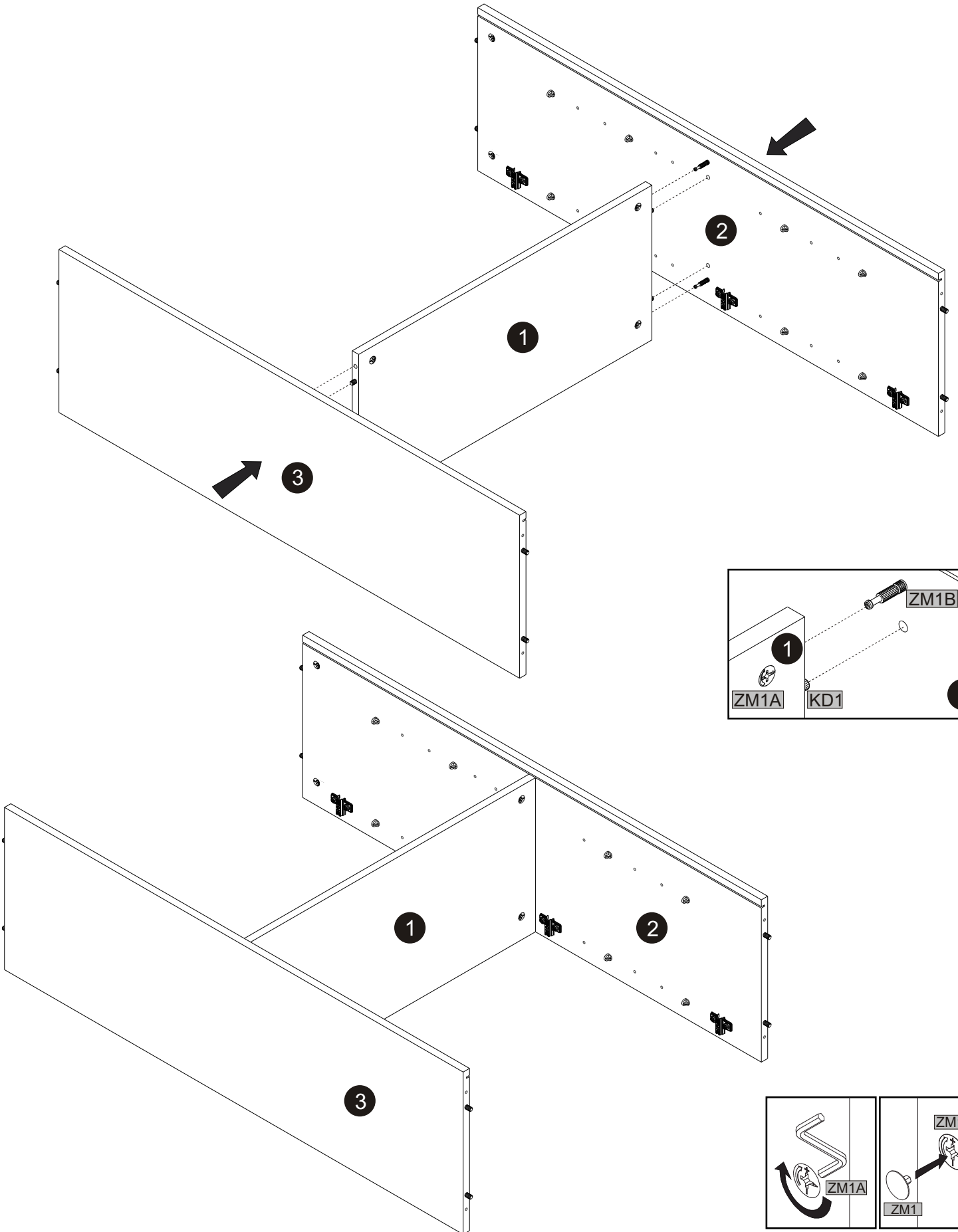

05

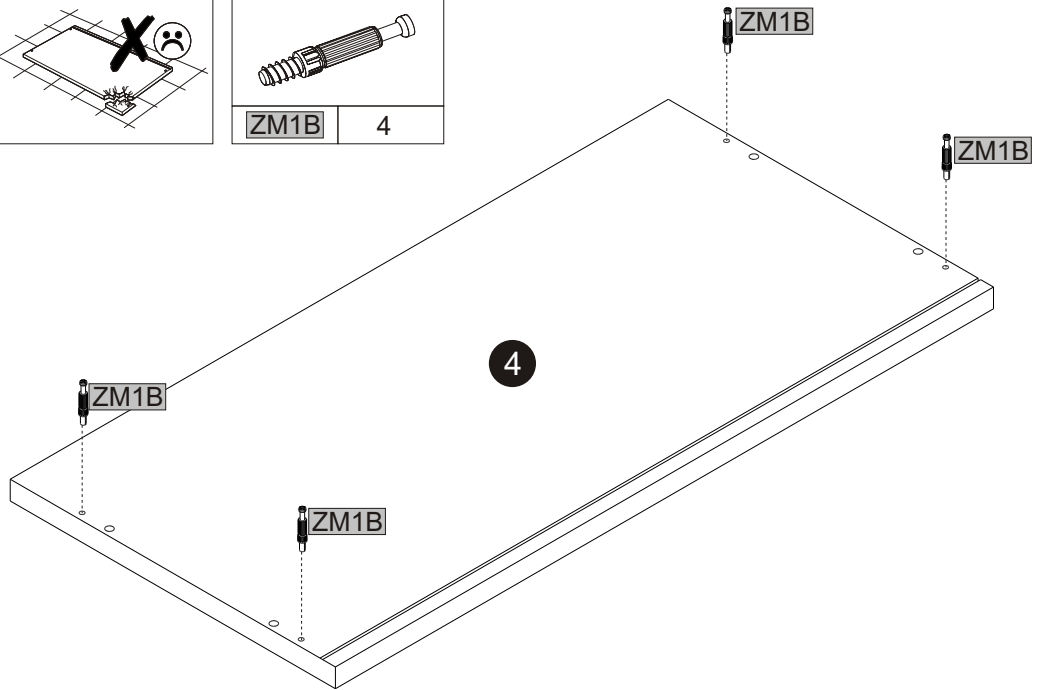
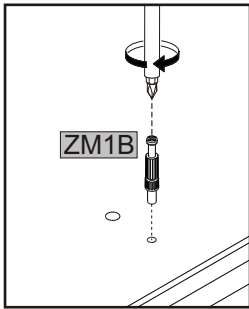
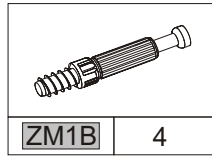
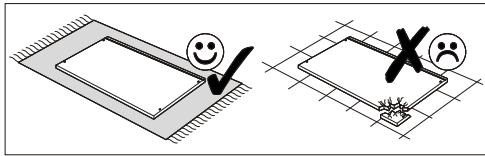

06

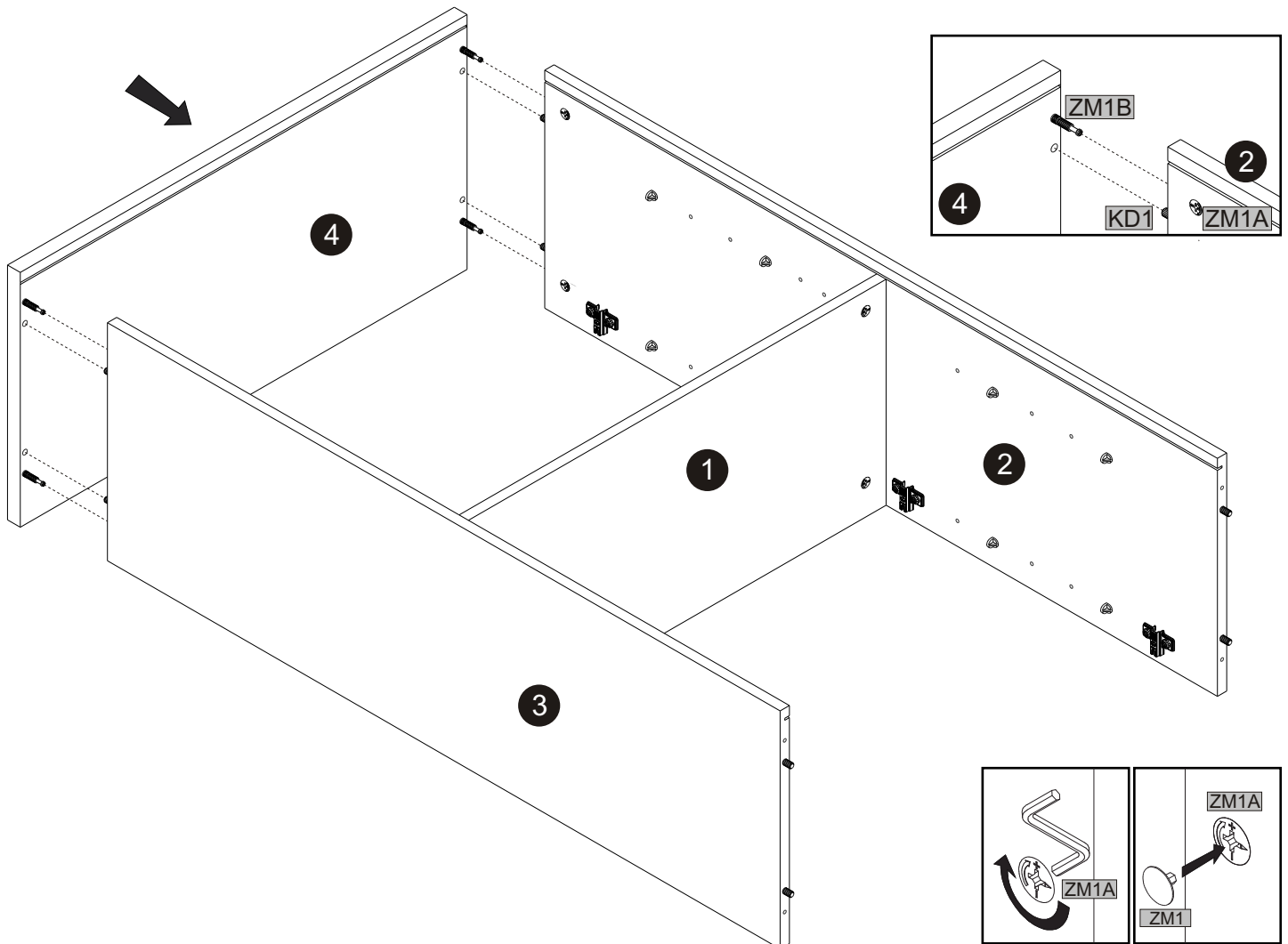
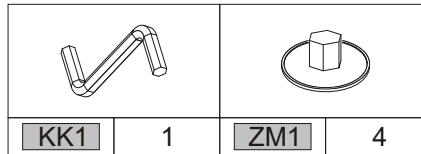
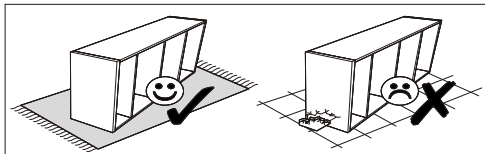

07

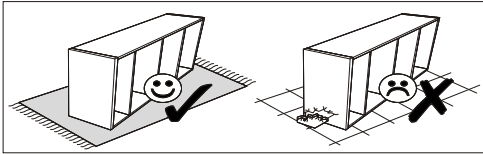

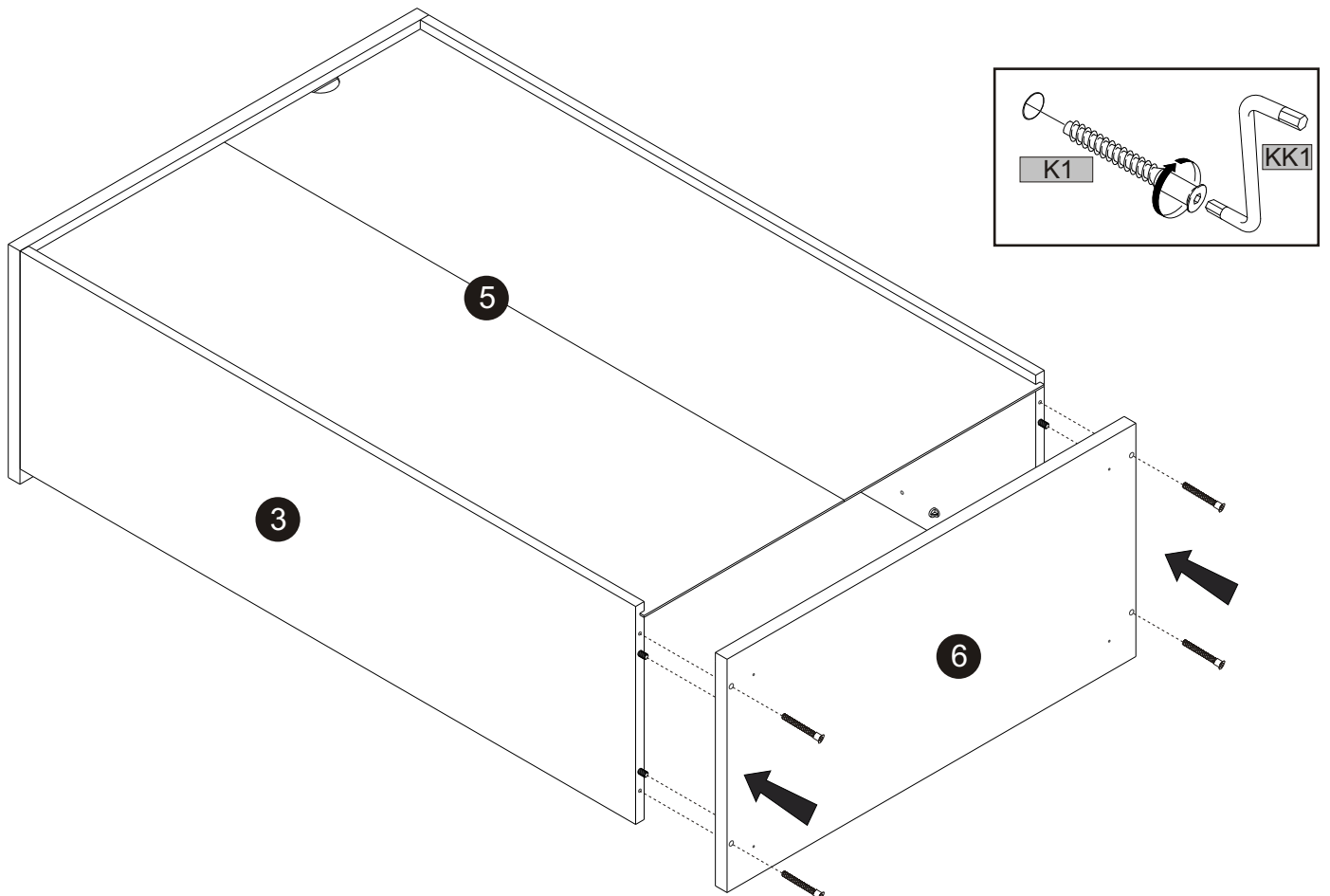
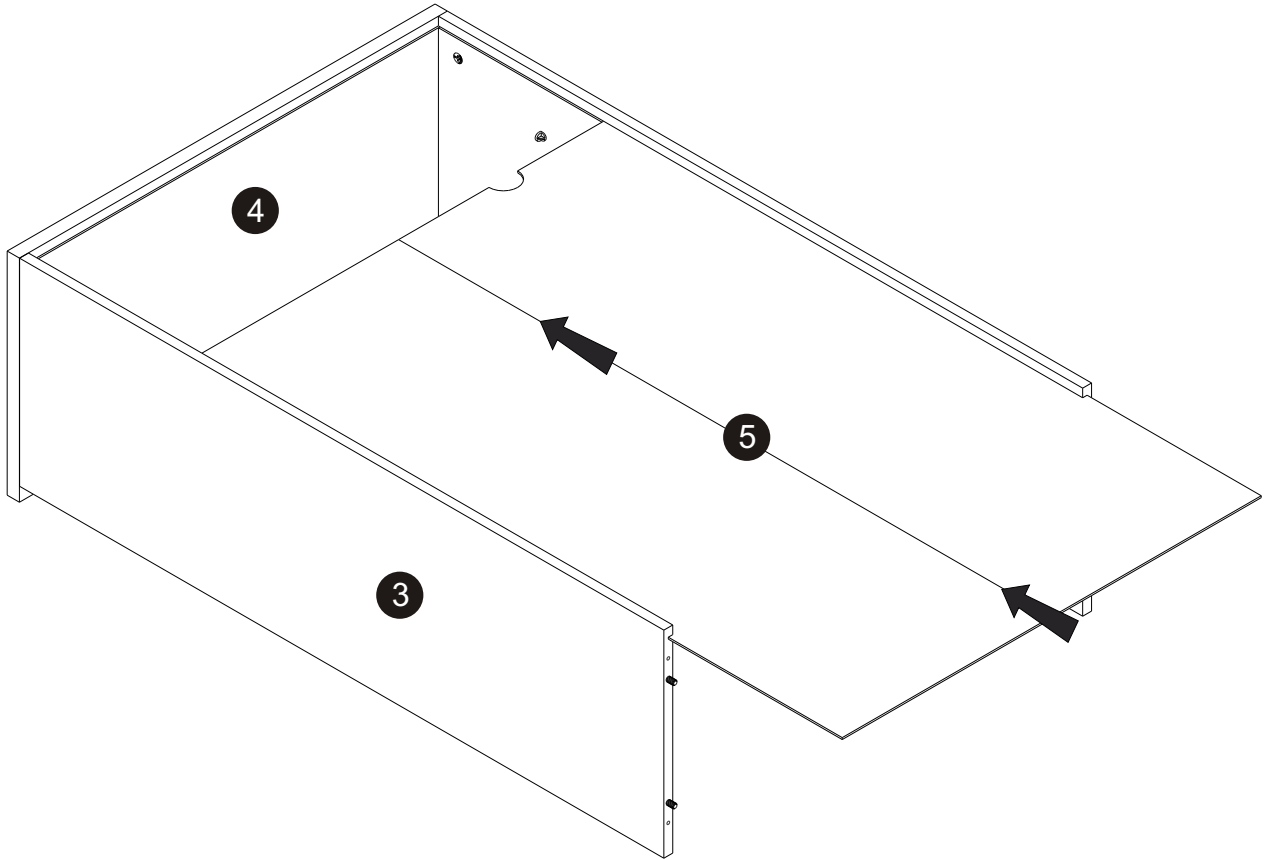

			7x50
KK1	1	K1	4

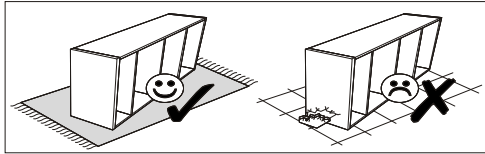

08



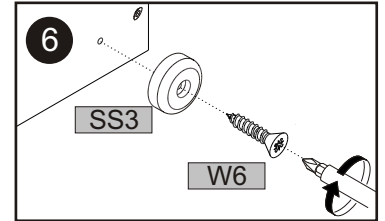
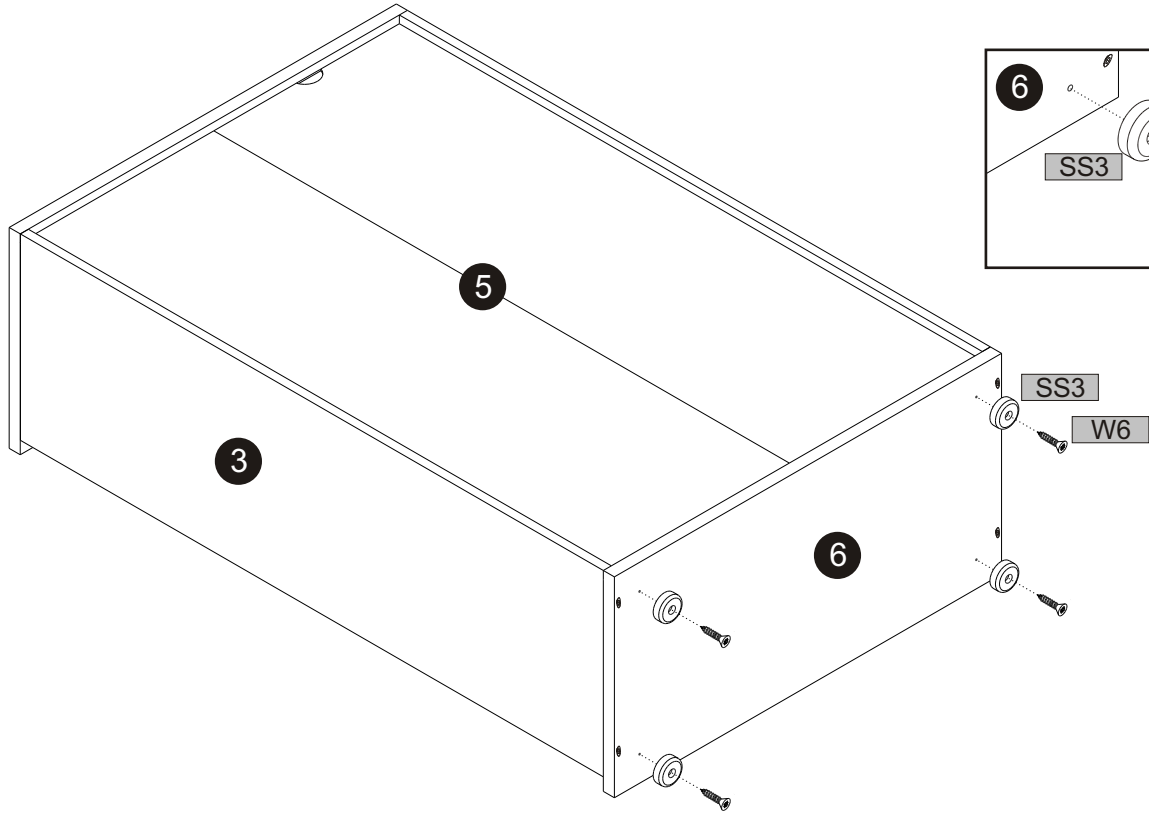

	4x20		
W6	4	SS3	4

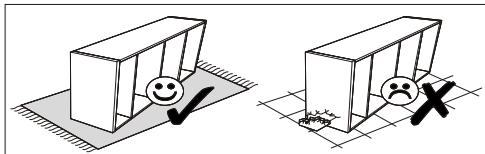

09



	3x16		
W1	4	S1	10

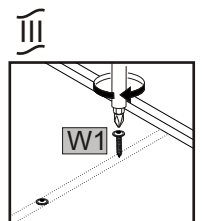
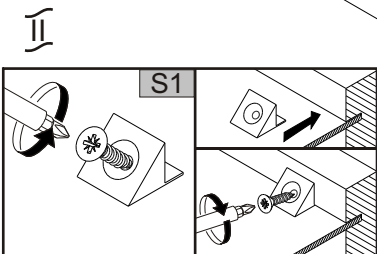
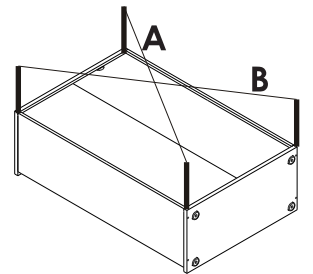
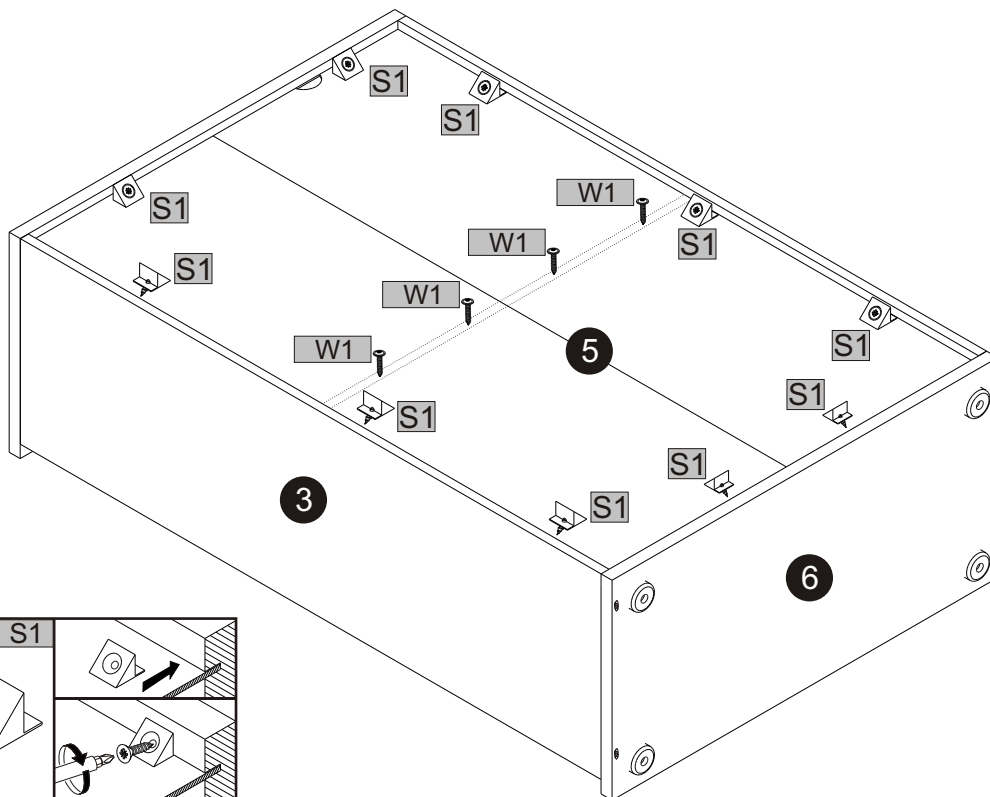
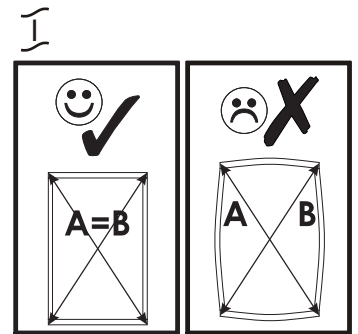

10

KS1	1	KRW1	1	W11	2

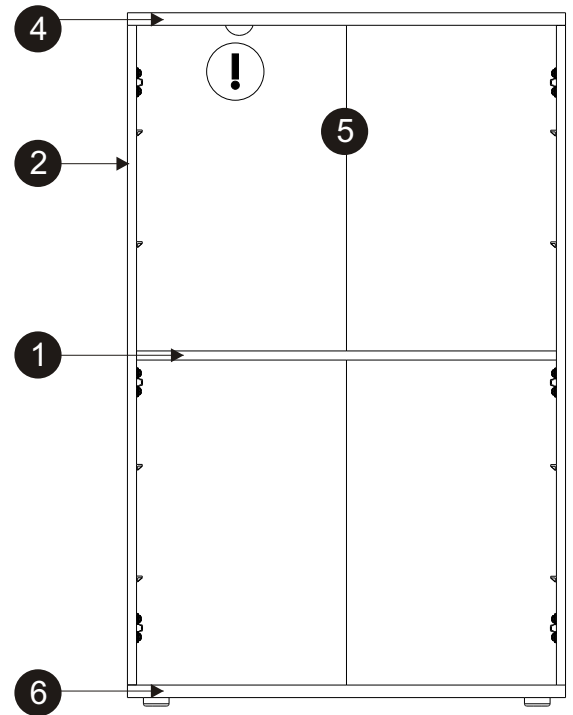
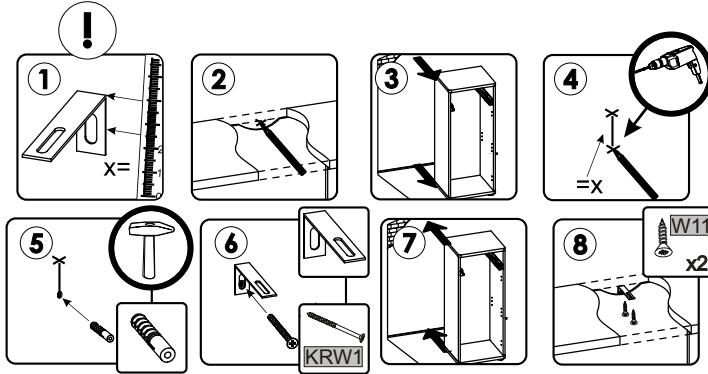

11

		W4	Z1P	KD2	TPP1
		6	3	6	4

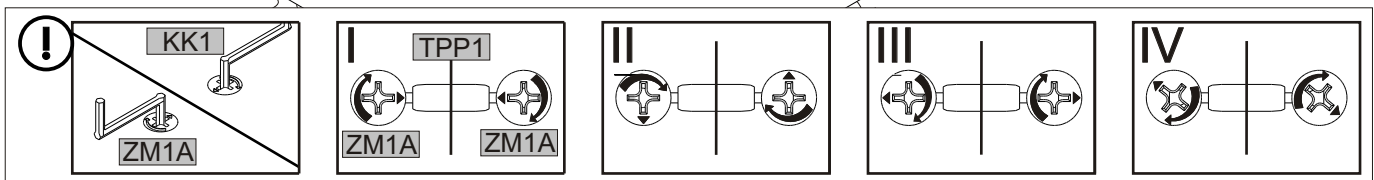
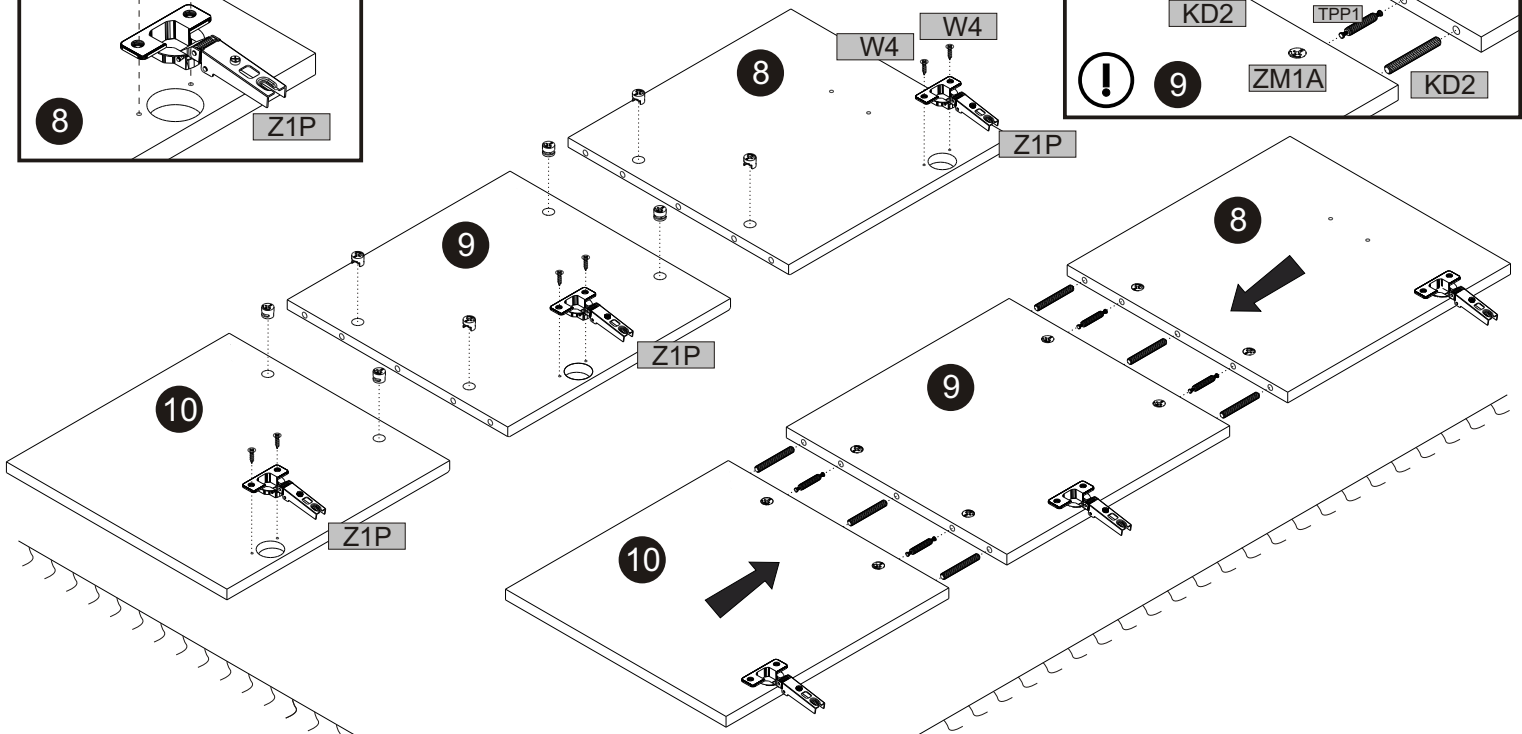
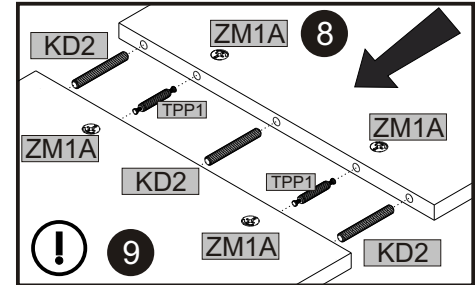
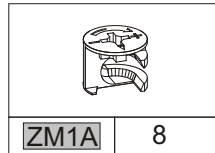
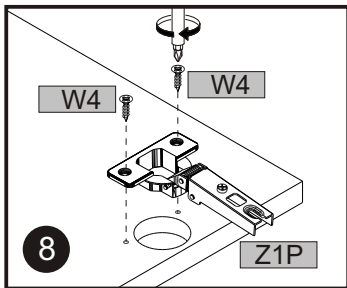

12

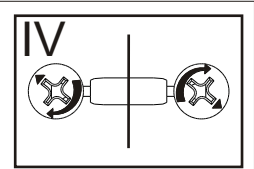
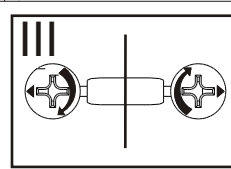
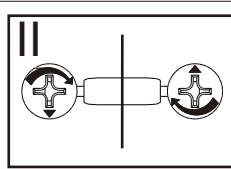
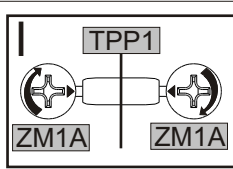
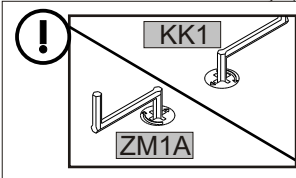
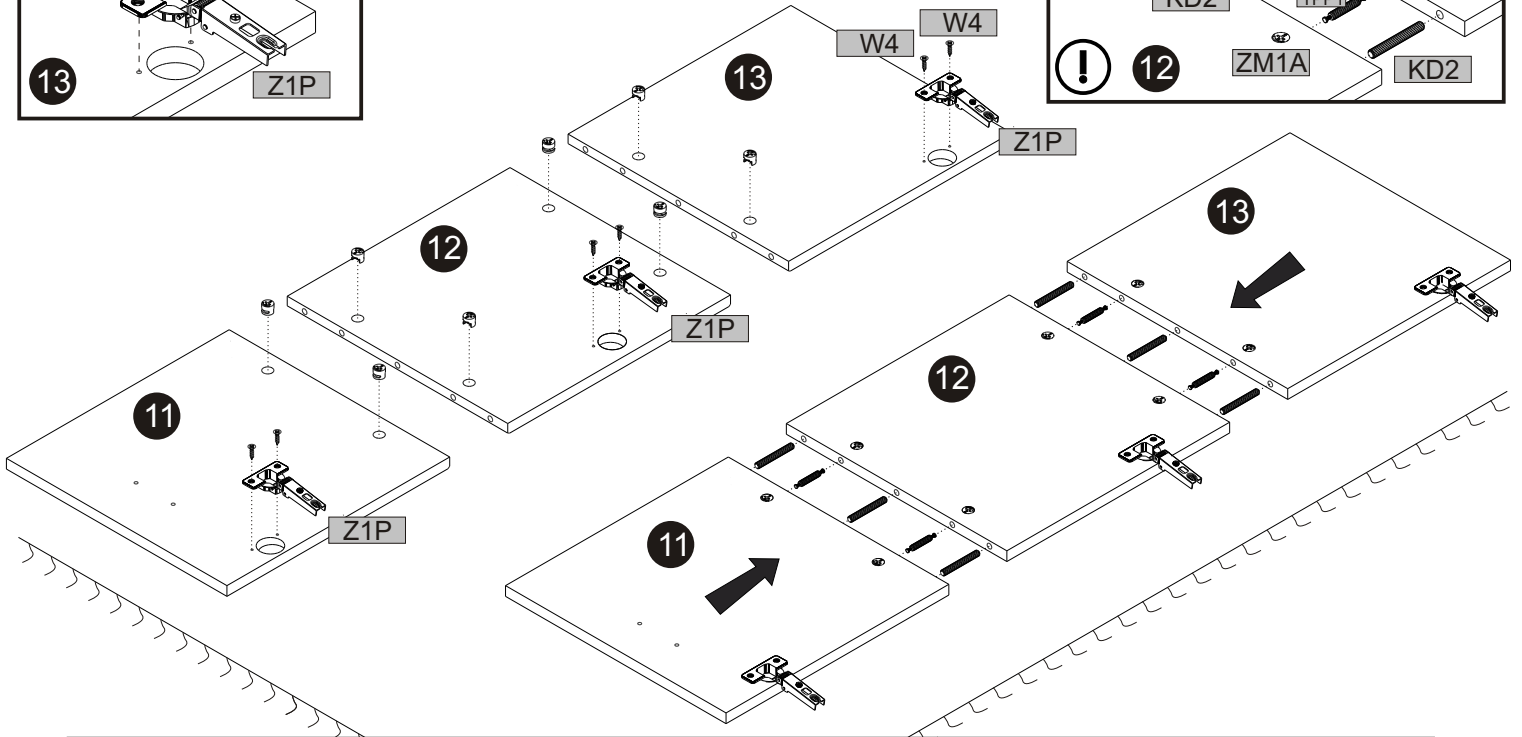
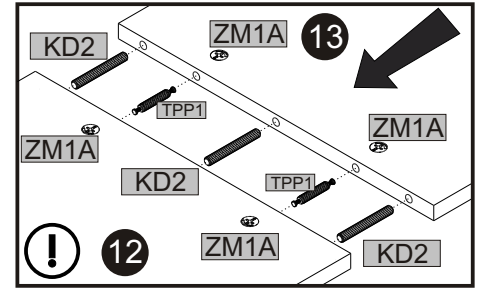
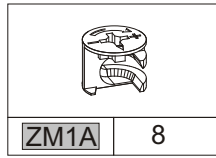
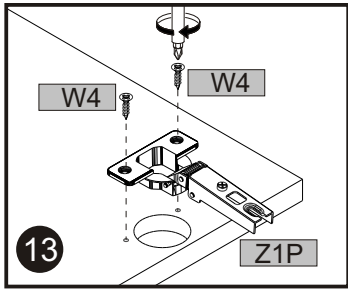
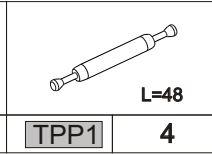
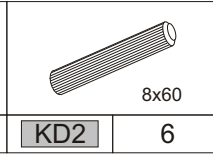
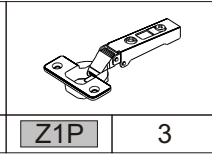
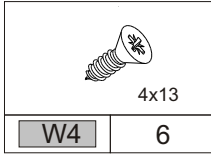
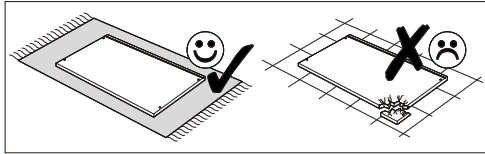

13

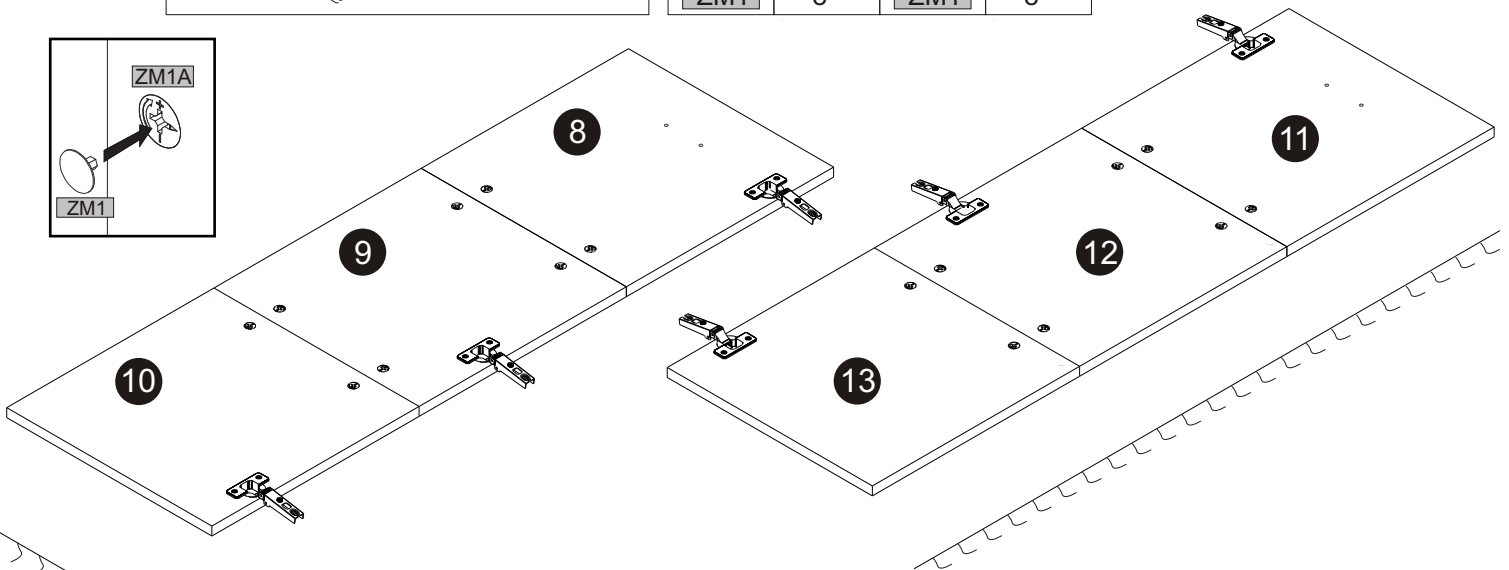
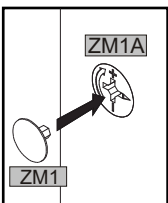
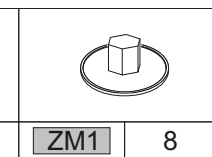
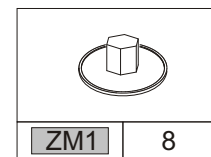
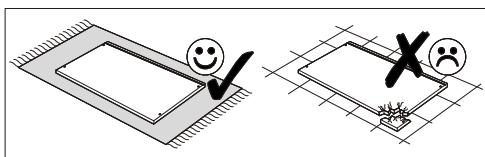

14

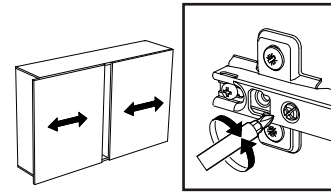
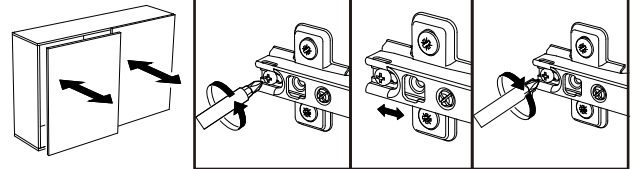
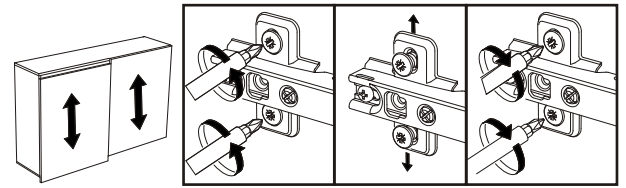
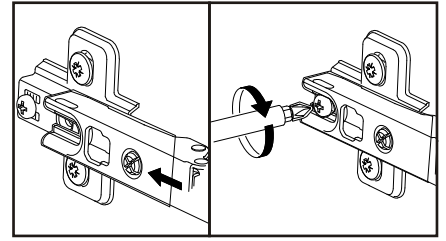
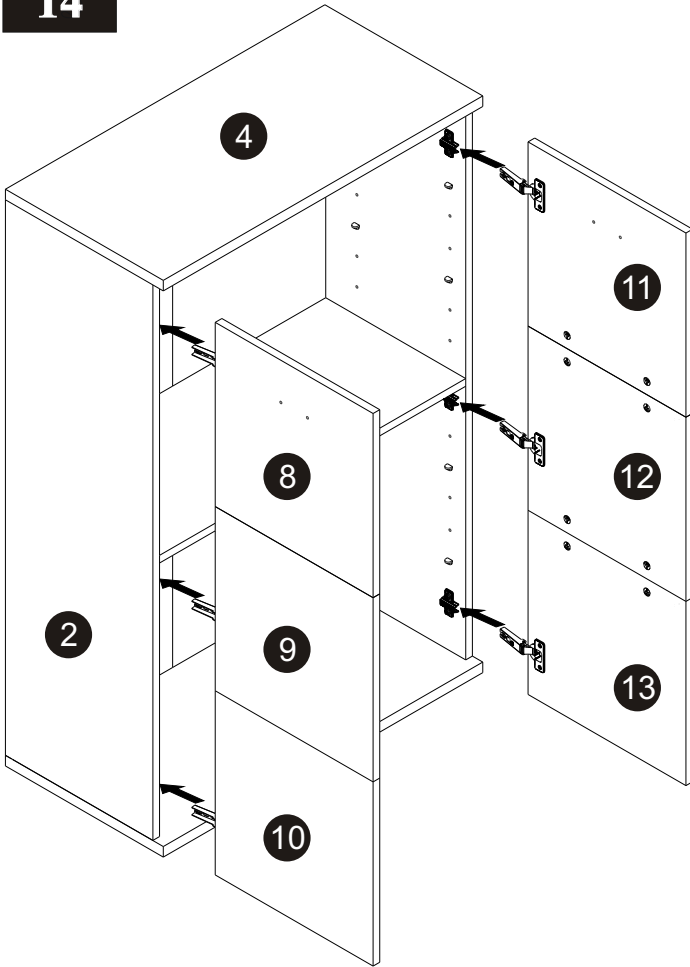

15

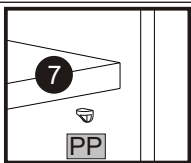

	U99	2		WU	4
					3,5x27

