









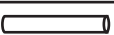

# ASSEMBLY INSTRUCTION

Item NO.: Wave

Item NO.: LCT022

HARDWARE LIST			
NO.	PART	DESCRIPTION	Q'TY
A		glass top	1
B		glass bottom	2
C		rod	4
D	 19cm	stainless tube	4
E	 26.2cm	stainless tube	1
F	 11.6cm	stainless tube	3
G	 6.2cm	stainless tube	2
H		feet	4
I		caps	4
J		screw nut	4
K		plastic gasket	12

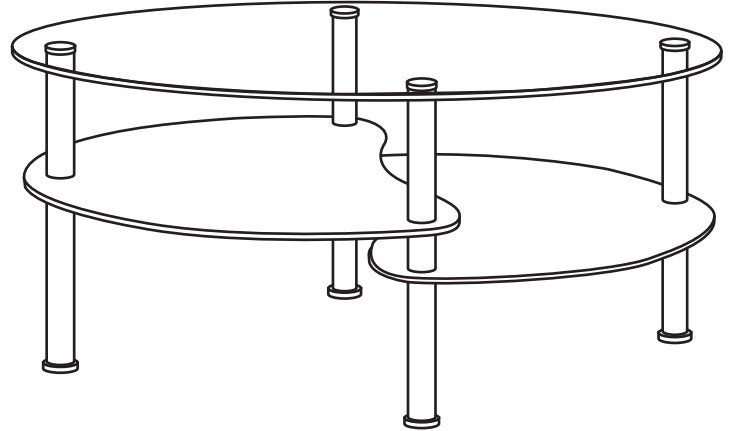

step 1

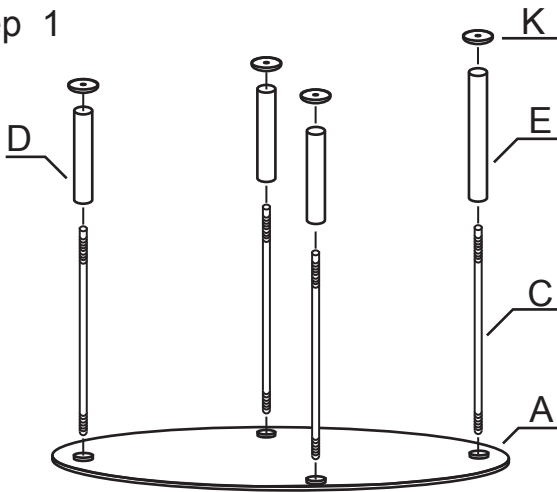

step 2

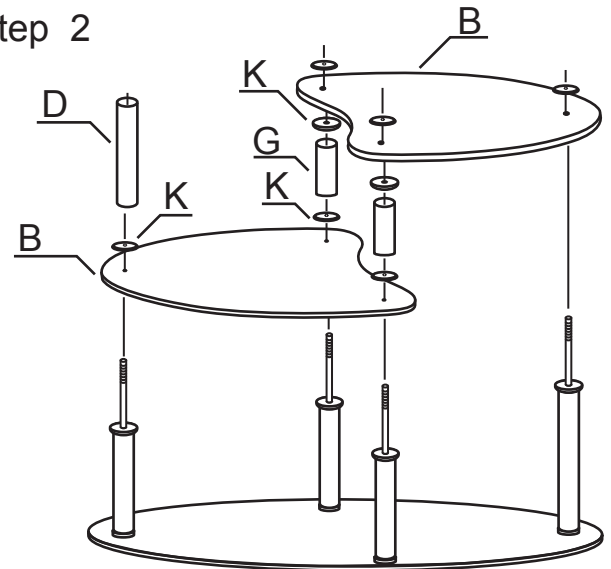

step 3

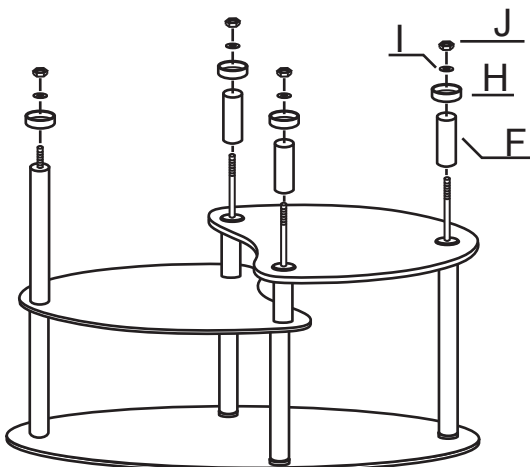

step 4

