

A	B	C (mm)		D
1	L106-106	1996	290	22
2	L106-107	458	200	22
3	L106-108	458	200	22
4	L106-110	900	200	22
5	L106-112	900	200	22
6	L106-113	1996	290	22
7	L106-114	1046	622	18
8	L106-115	1046	180	18
9	ZZ1-431	64	70	27
10	ZZ1-466	293	70	27
11	ZZ1-719	1983	70	27
12	ZZ1-747	1880	25	25
13	L106-007	1038	270	15
14	L106-506	650	190	15
15	L106-507	650	190	15
16	L106-508	634	80	15
17	L106-510	992	190	15
18	L106-907	1002	644	2,5

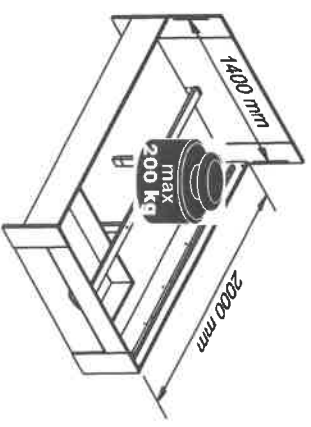

4x Ø7,5/50 mm e1	16x Ø6,3x13 mm e2	8x Ø6,13 mm e3	2x Ø7,5/50 mm e27	24x Ø8,5/30 mm f1	12x Ø6,5/30 mm f6	4x 1/8x1/5 T17M j132
4x k1	4x Ø25 mm k34	2x Ø15-16 T17M #22 n3411	2x Ø10-13 T17M n3412	2x 110x90 mm n180	10x Ø6x4/0 mm p10	6x Ø3,5x1,5 mm p16
8x Ø8,5/15 T17M p38	24x Ø15,12 T17M #18 r1	4x Ø15-16 T17M #22 r3	4x Ø10-13 T17M r511	8x 110x90 mm r10	12x 20/1 r42	1x 4 mm z1

**S14**

16x  
Ø4x25 mm  
p36

4x  
Ø8x25 mm  
o89

4x  
Ø4x4/0 mm  
p10

**1A**

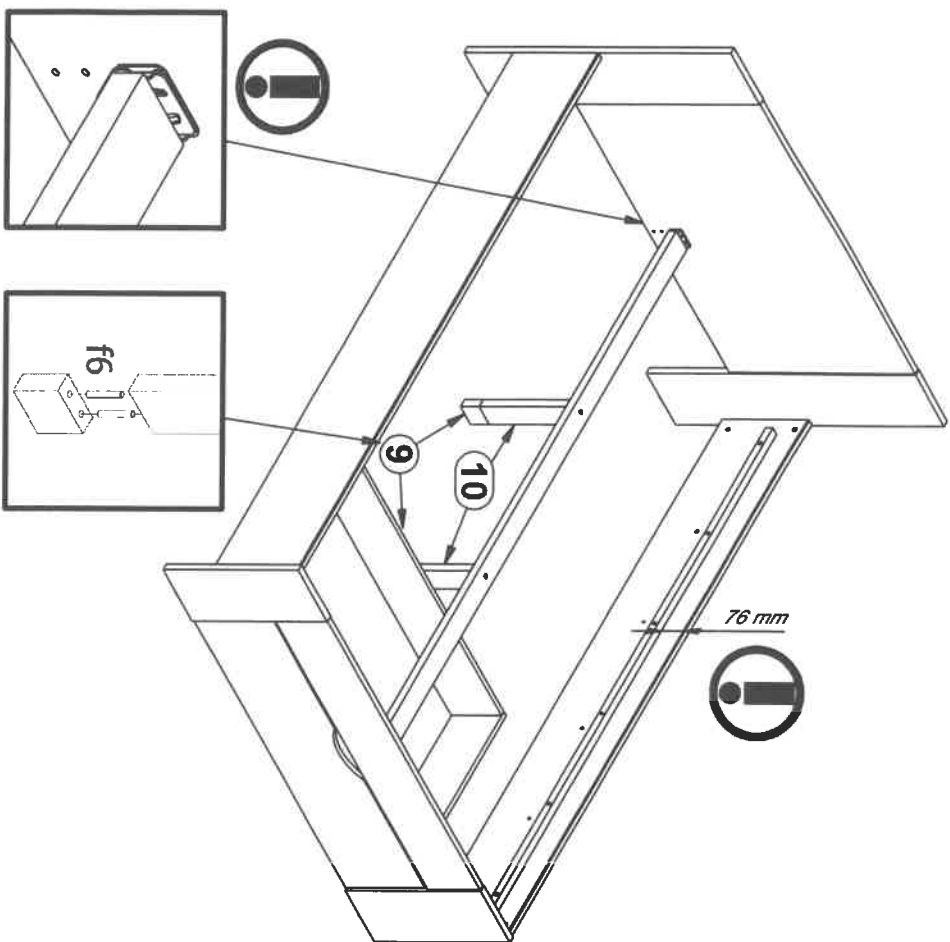

**1B**

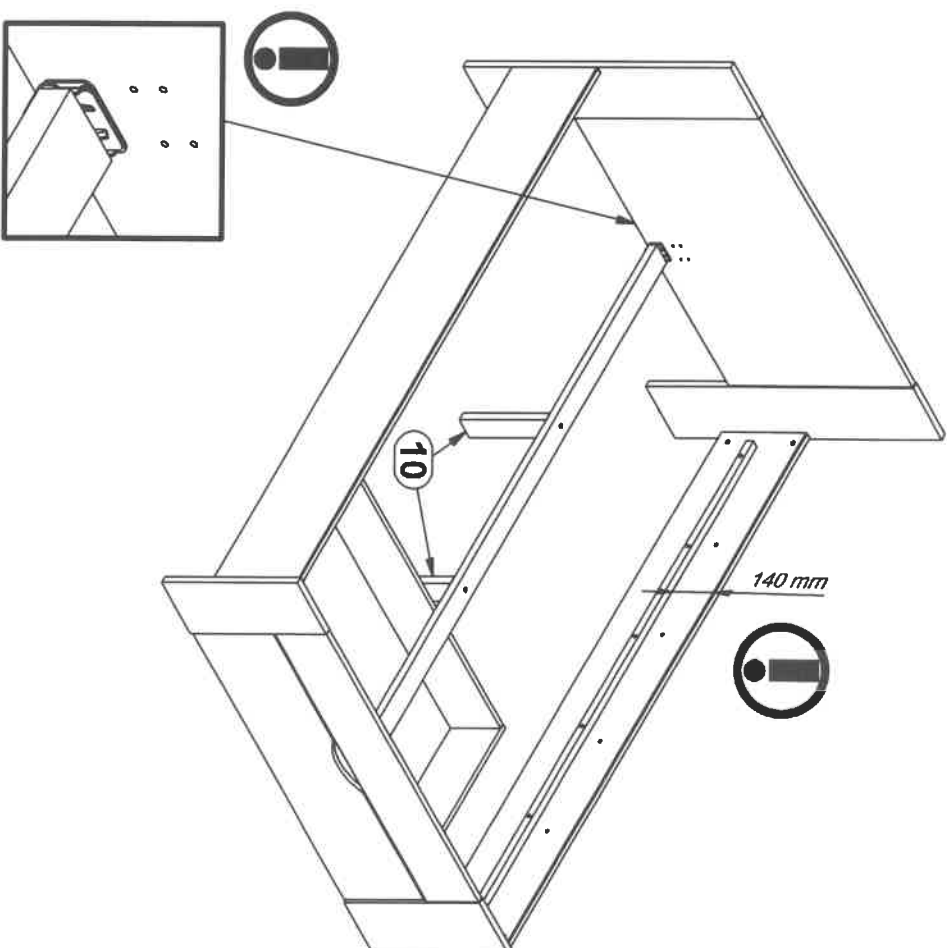

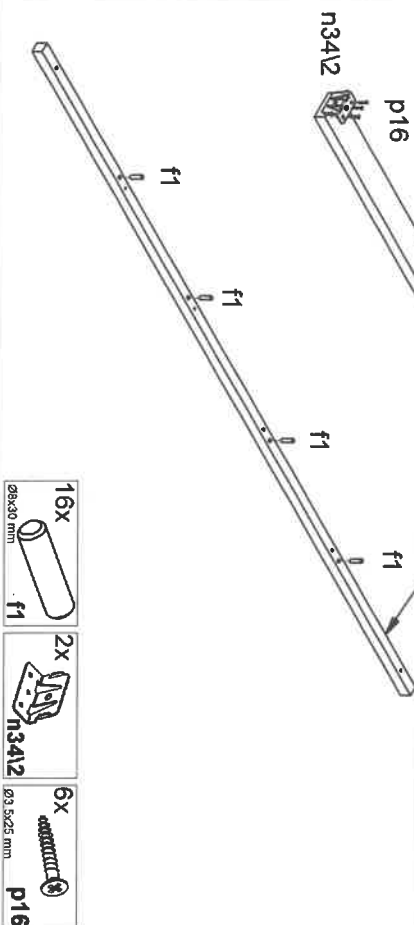
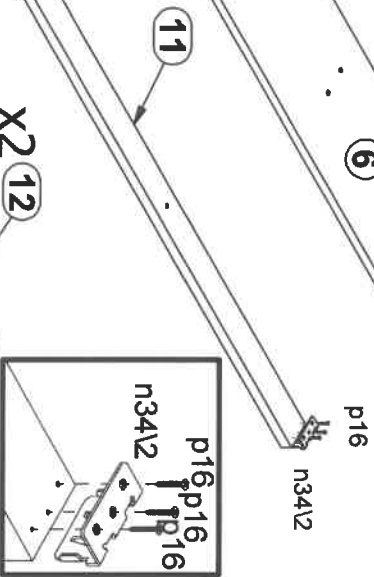
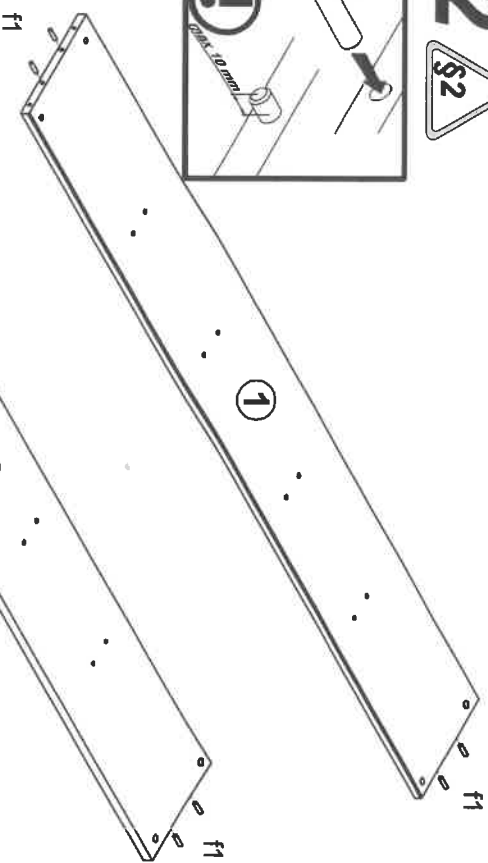
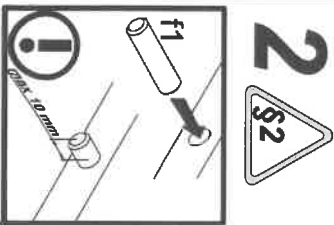

- 16x  $\varnothing$ 3x30 mm
- 2x
- 6x  $\varnothing$ 3.5x25 mm

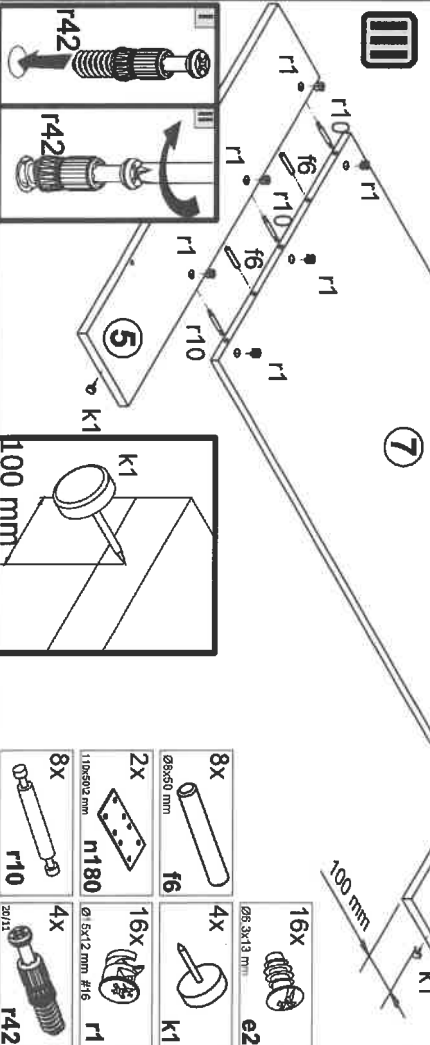
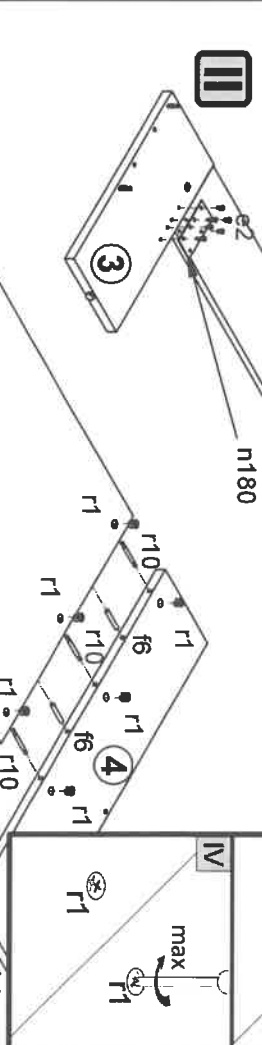
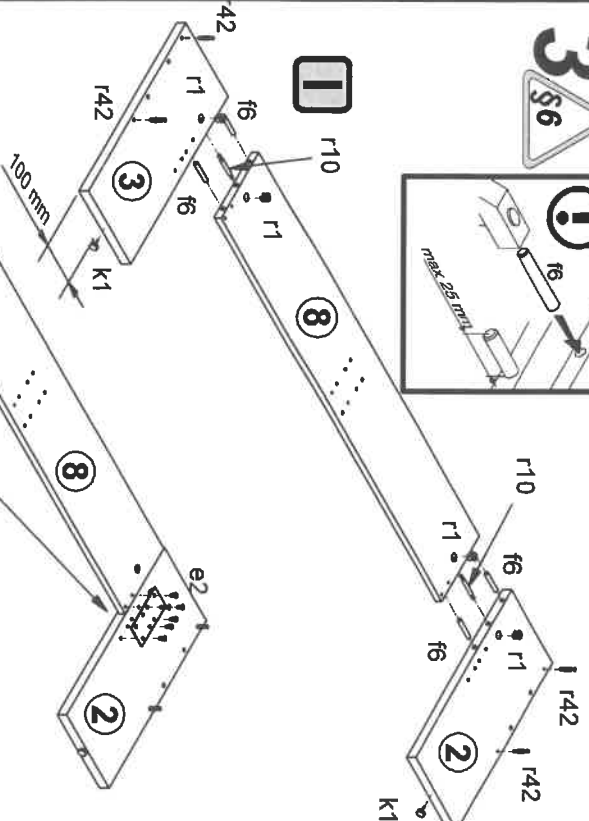
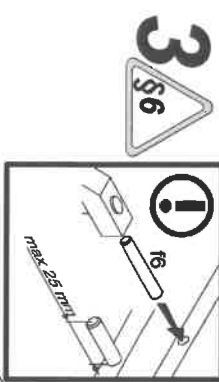

- 8x  $\varnothing$ 5x50 mm
- 2x  $\varnothing$ 1.10x90x3 mm
- 8x  $\varnothing$ 5x12 mm #16
- 16x  $\varnothing$ 5.3x13 mm
- 4x
- 4x
- 8x  $\varnothing$ 5x12 mm #16

# 4

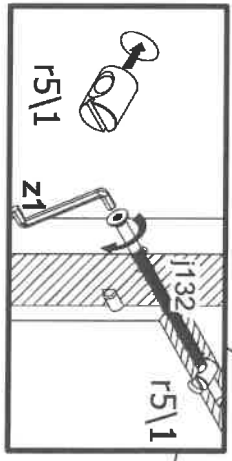
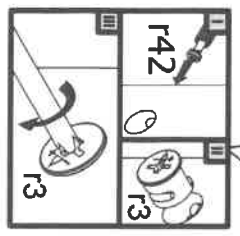
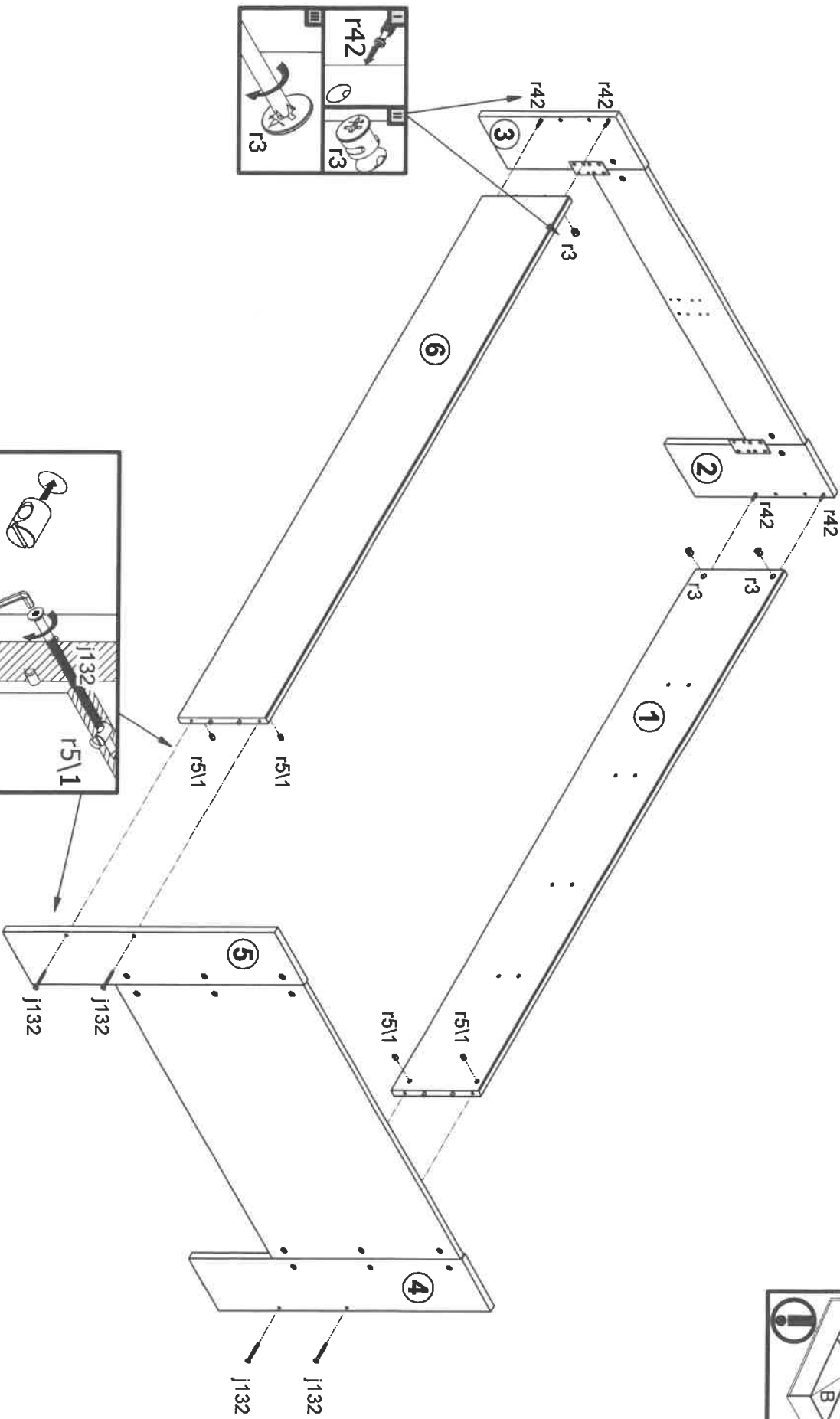
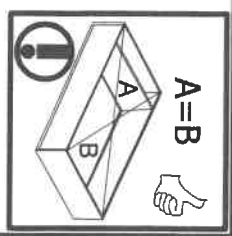

- 4x r42 16x55 mm
- 4x r3 Ø15x15 mm, 2°
- 4x r511 Ø10x13 mm
- 4x j132

# 5A

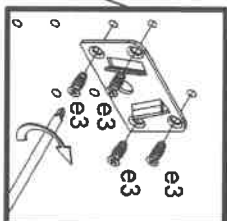
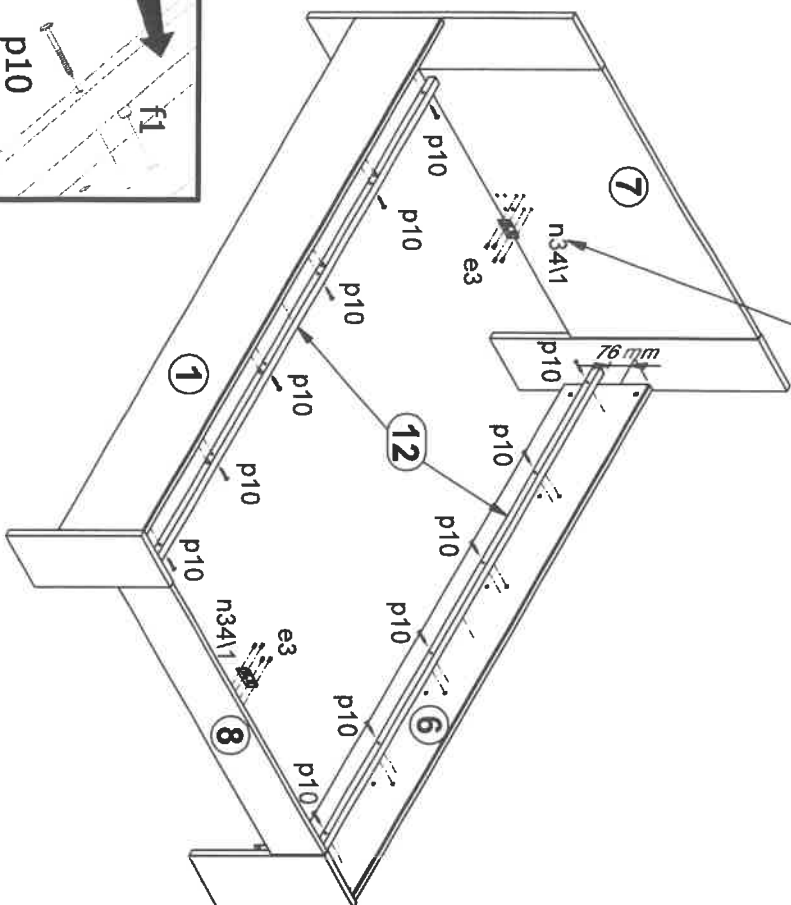
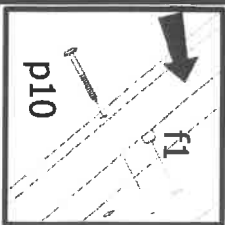

# 5B

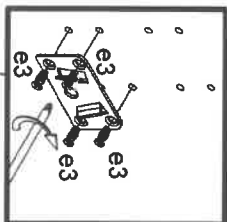
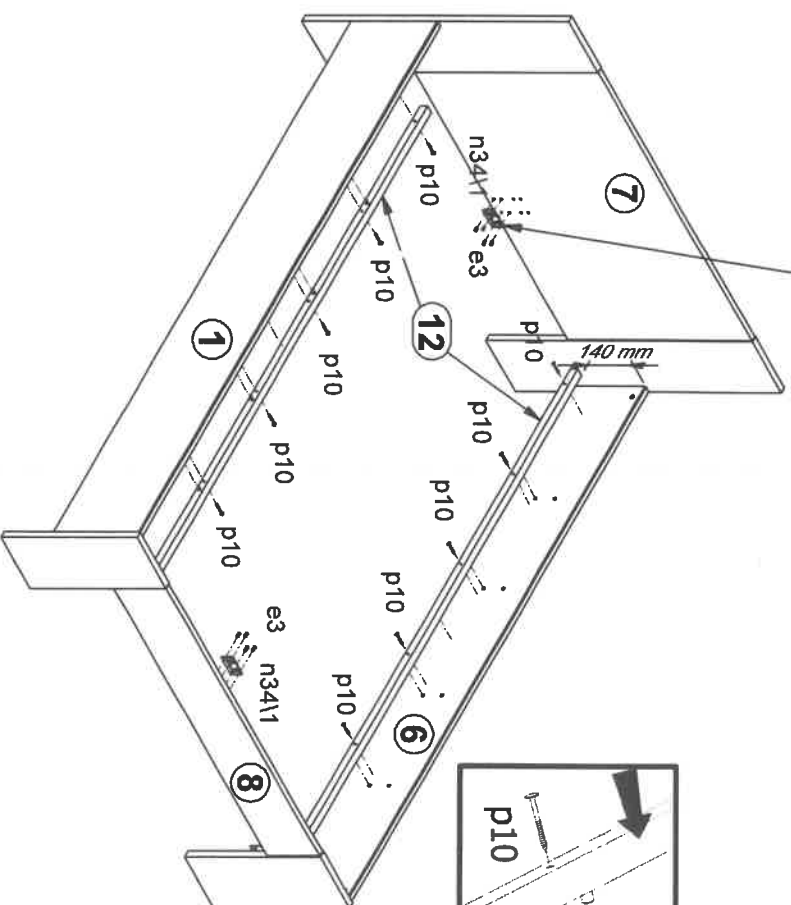
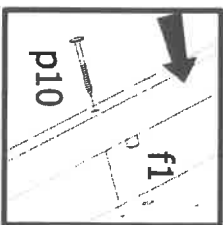

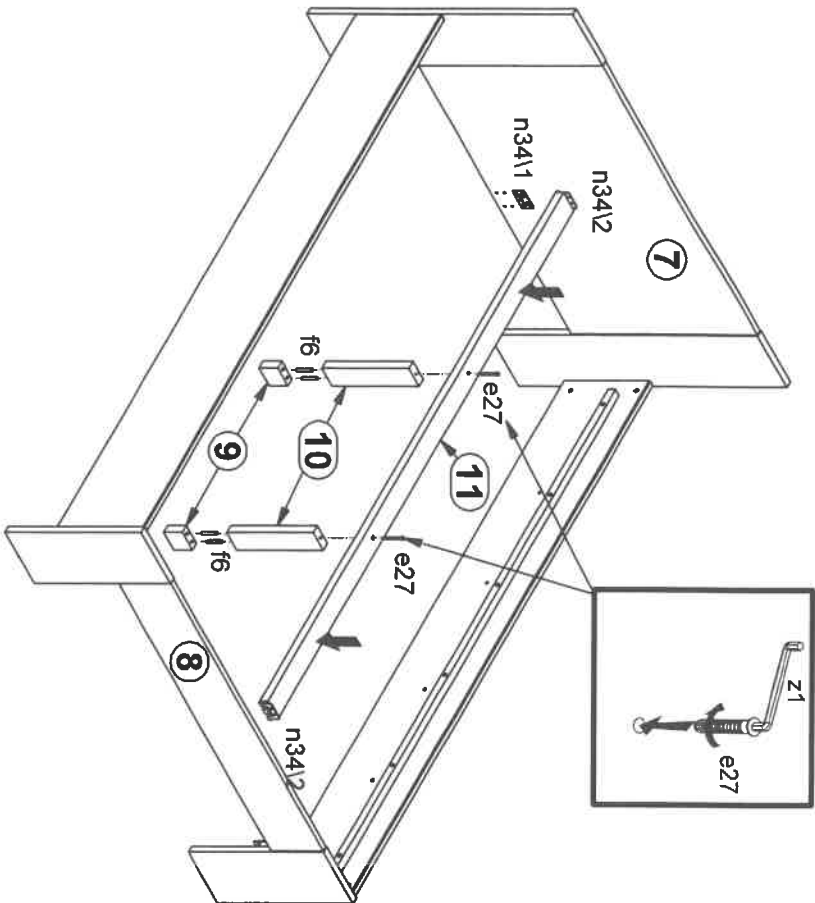

8x		20x13 mm	e3
2x		n3411	
12x		Ø4x40 mm	p10

**6A**  
S14

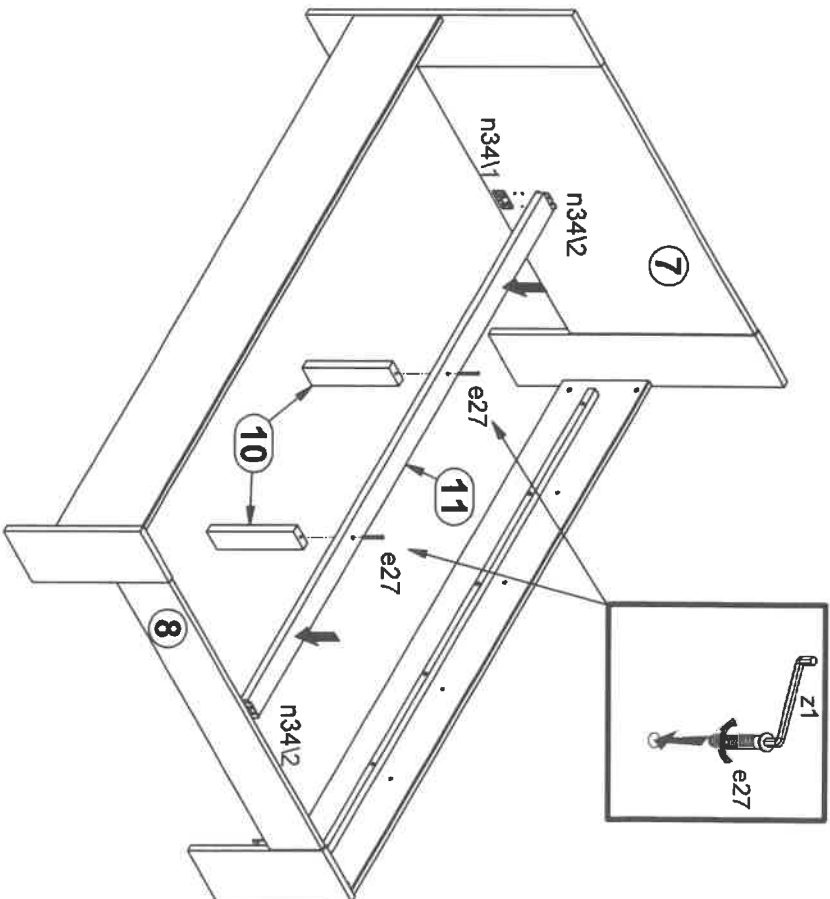

**6B**  
S14



2x		4x	
	Ø7x20 mm		Ø8x50 mm
	e27		f6

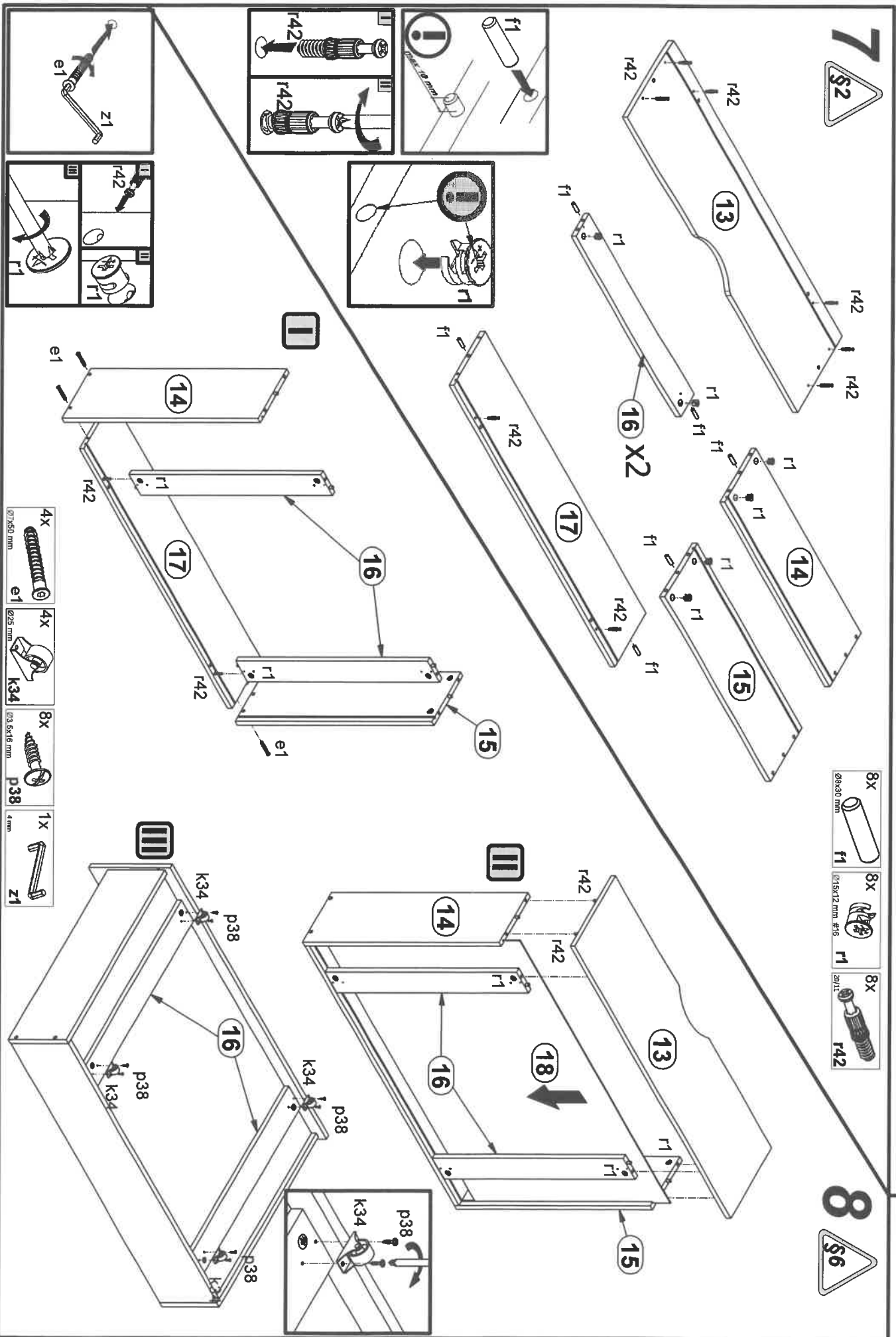

- 8x Ø9x30 mm f1
- 8x (13x12 mm) #16 r1
- 8x 20x11 r42

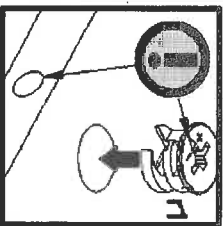
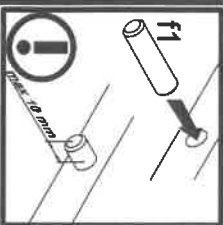

II

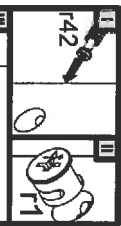
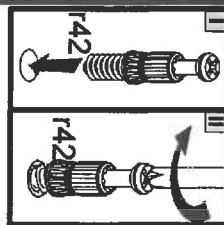

- 4x Ø7x50 mm e1
- 4x Ø25 mm k34
- 8x Ø3.5x16 mm p38
- 1x 4 mm z1

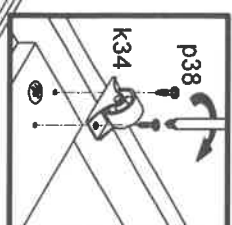

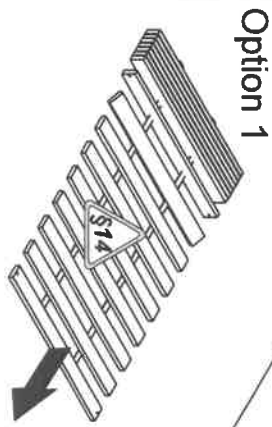
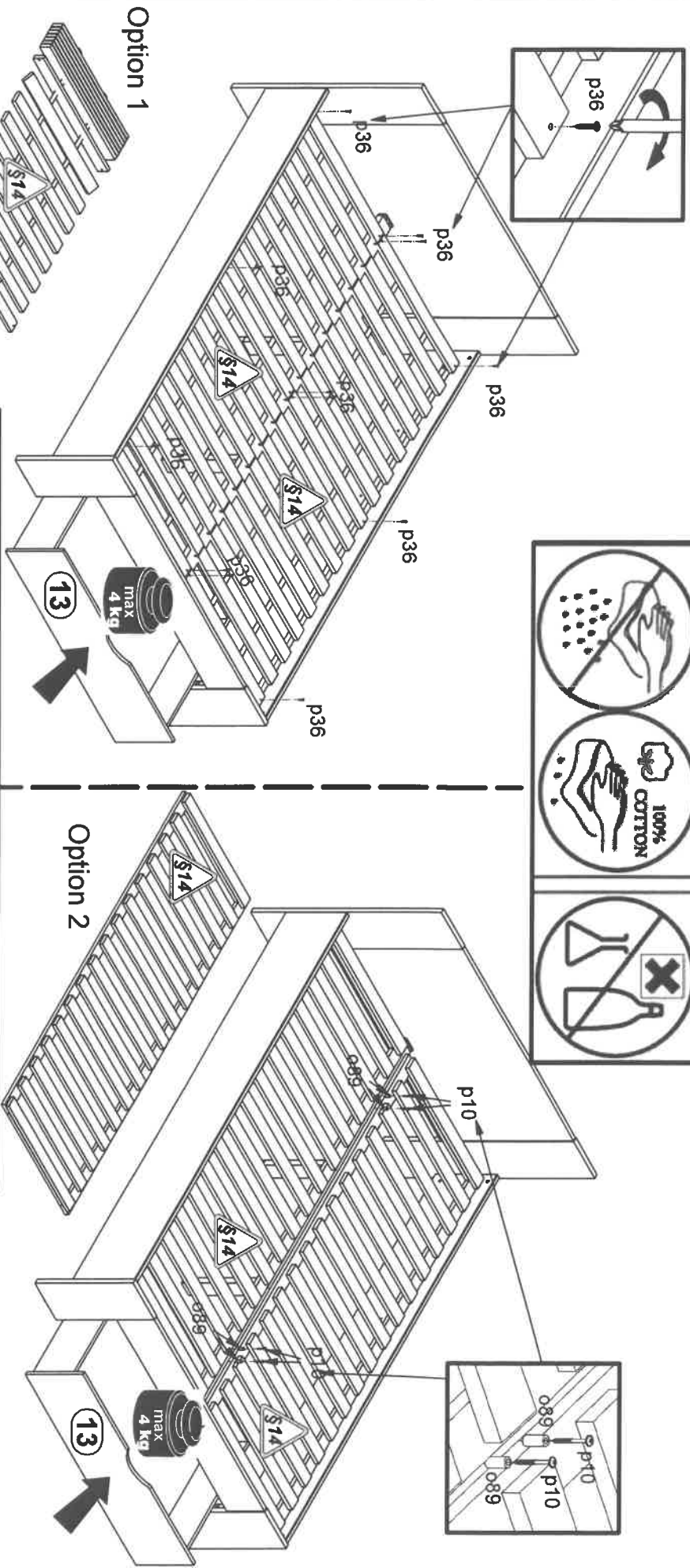
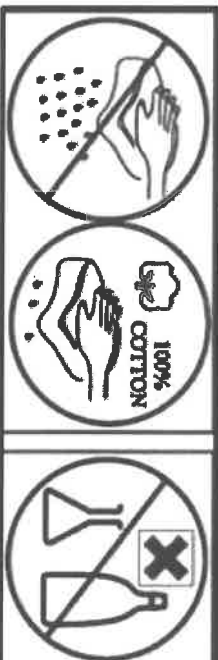

16x  
 p36  
 Ø4x25 mm

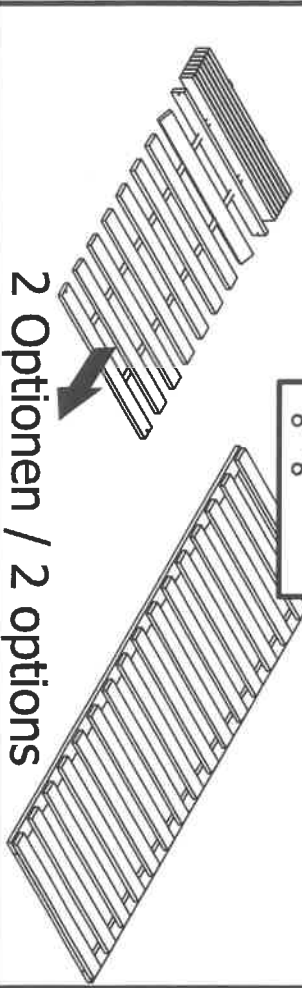
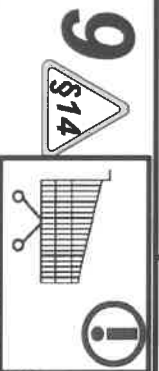

2 Optionen / 2 options

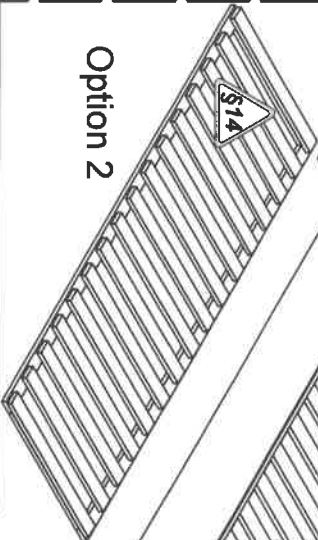

4x  
 089  
 Ø4x10 mm

4x  
 p10  
 Ø4x10 mm