

1/3

	H	B	T	
2	1158	337	16	x1
10	742	327	16	x4
11	361	327	16	x4

2/3

	H	B	T	
7	1174	756	3	x1
8	1174	378	3	x1
9	1152	380	22	x1
12	384	380	16	x1
13	384	380	16	x1
14	384	380	16	x1
15	384	380	16	x2
16	384	380	16	x2
17	384	380	16	x2

3/3

	H	B	T	
1	742	337	16	x1
3	361	337	16	x1
4	1158	355	16	x1
5	1158	355	16	x1
9	1152	380	22	x1

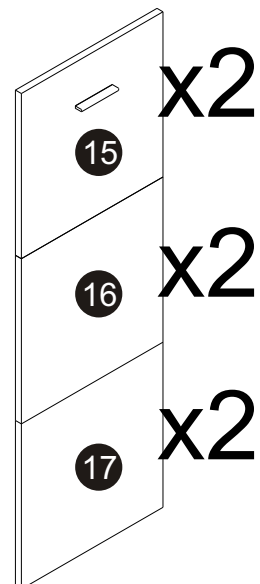
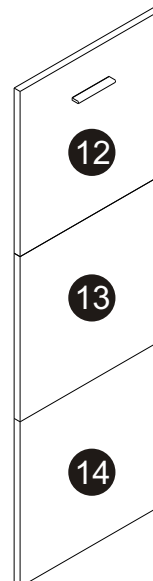
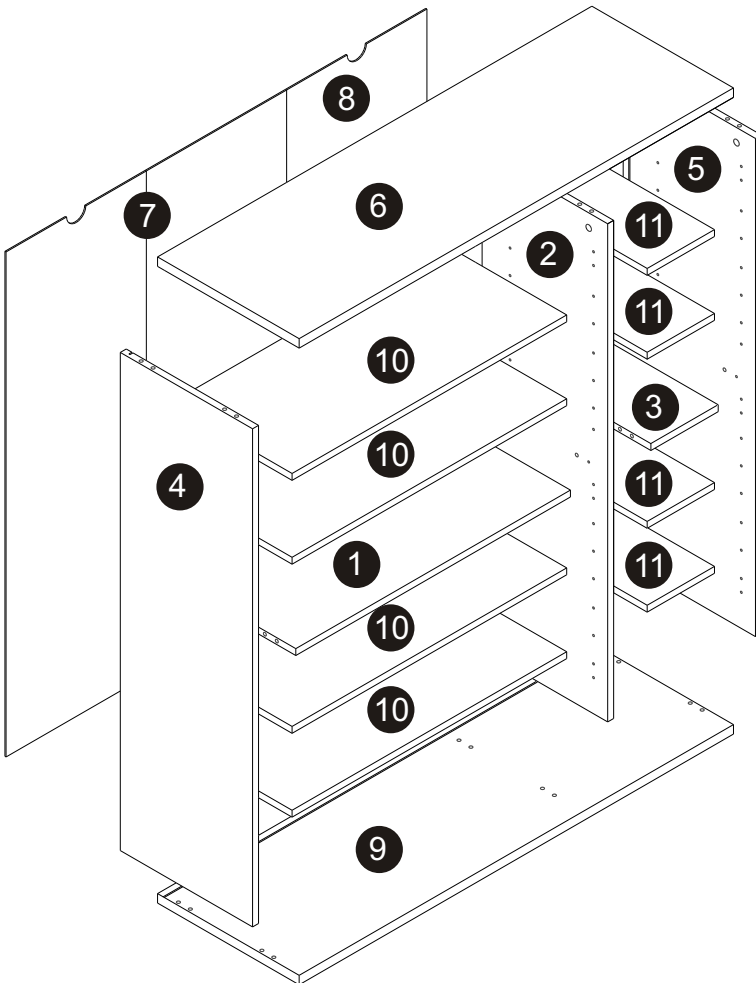

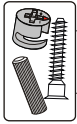

1/3

ZM1 26	ZM1 12	K1 6	KD1 16	KK1 1	W1 15
W4 18	ZP 6	Z1P 6	PP 32	W6 5	SS3 5
ZM1A 38	ZM1B 10	W11 4	S1 12	KS1 2	KRW1 2
KD2 20	TPP3 2	PL1 9	TPP1 12	U99 3	WU 6
ZP 3	ZP1 3				

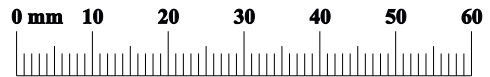

01

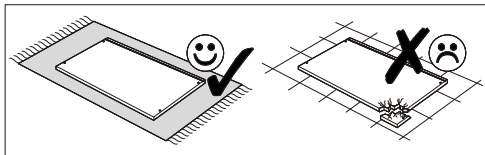

ZM1A 4	KD1 2

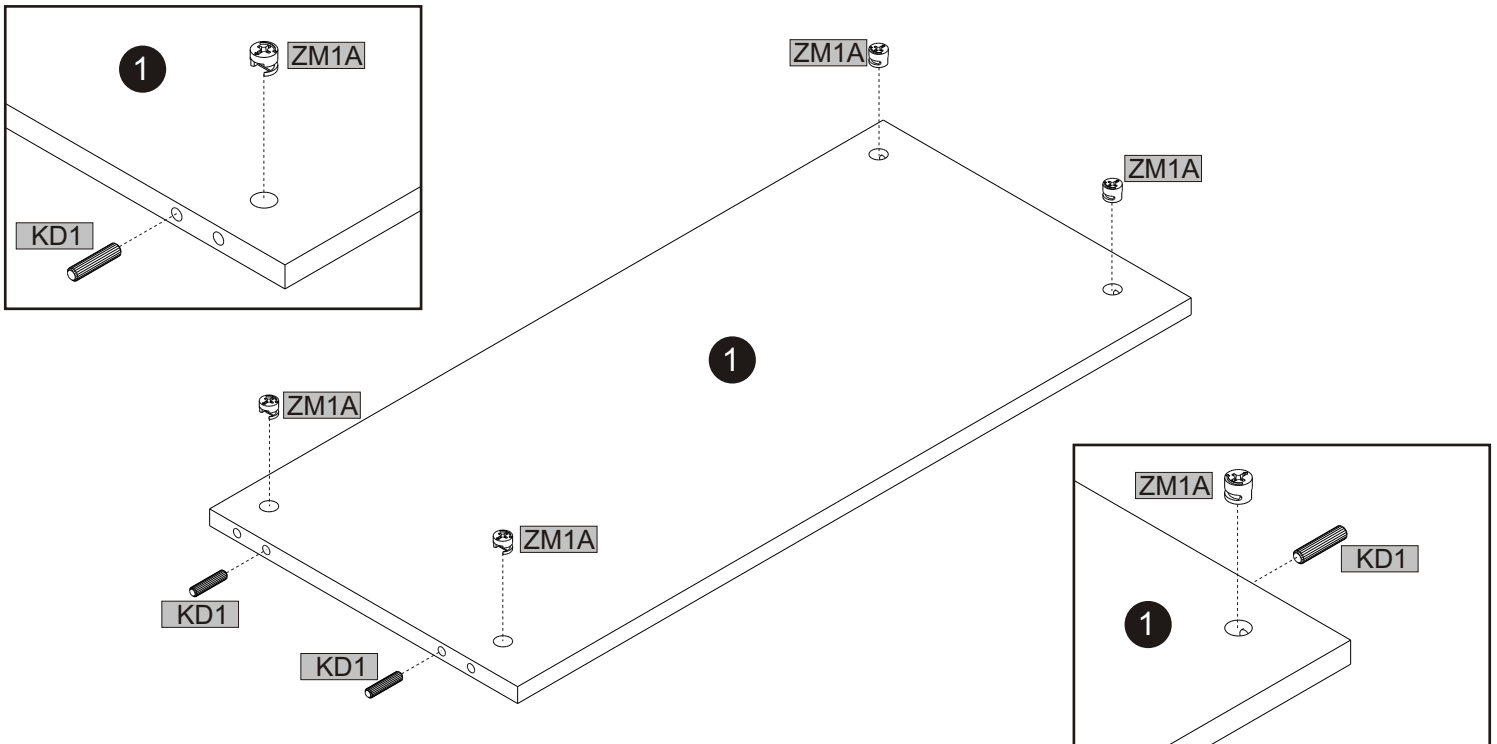

02

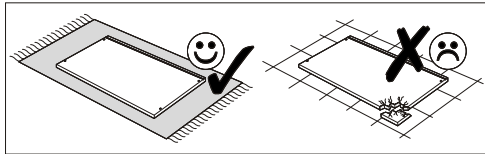

ZM1A	4	KD1	2

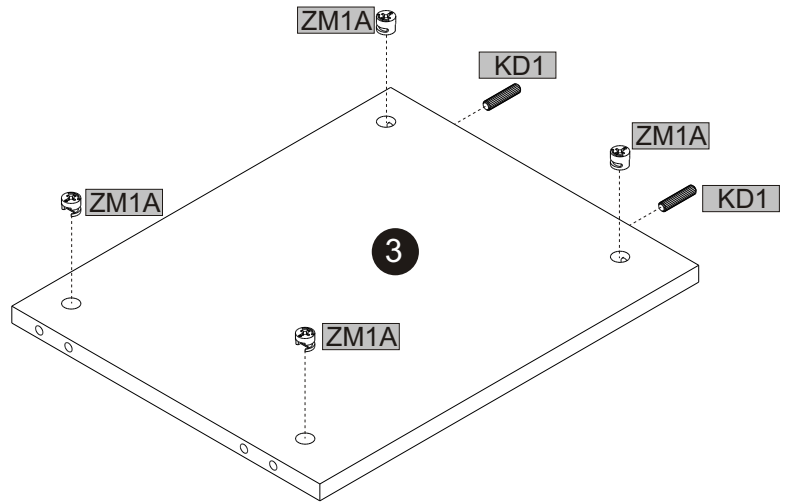
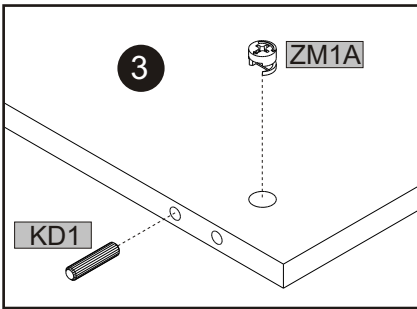

03

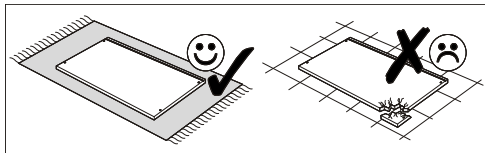

ZM1A	2	KD1	4

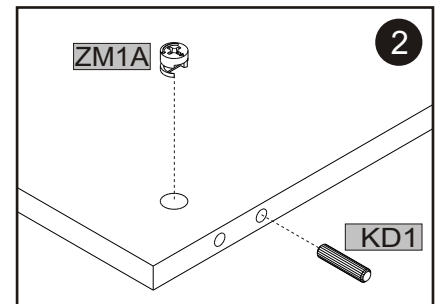
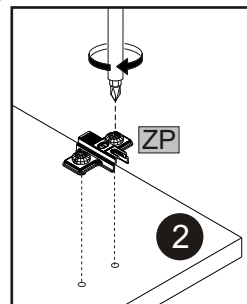
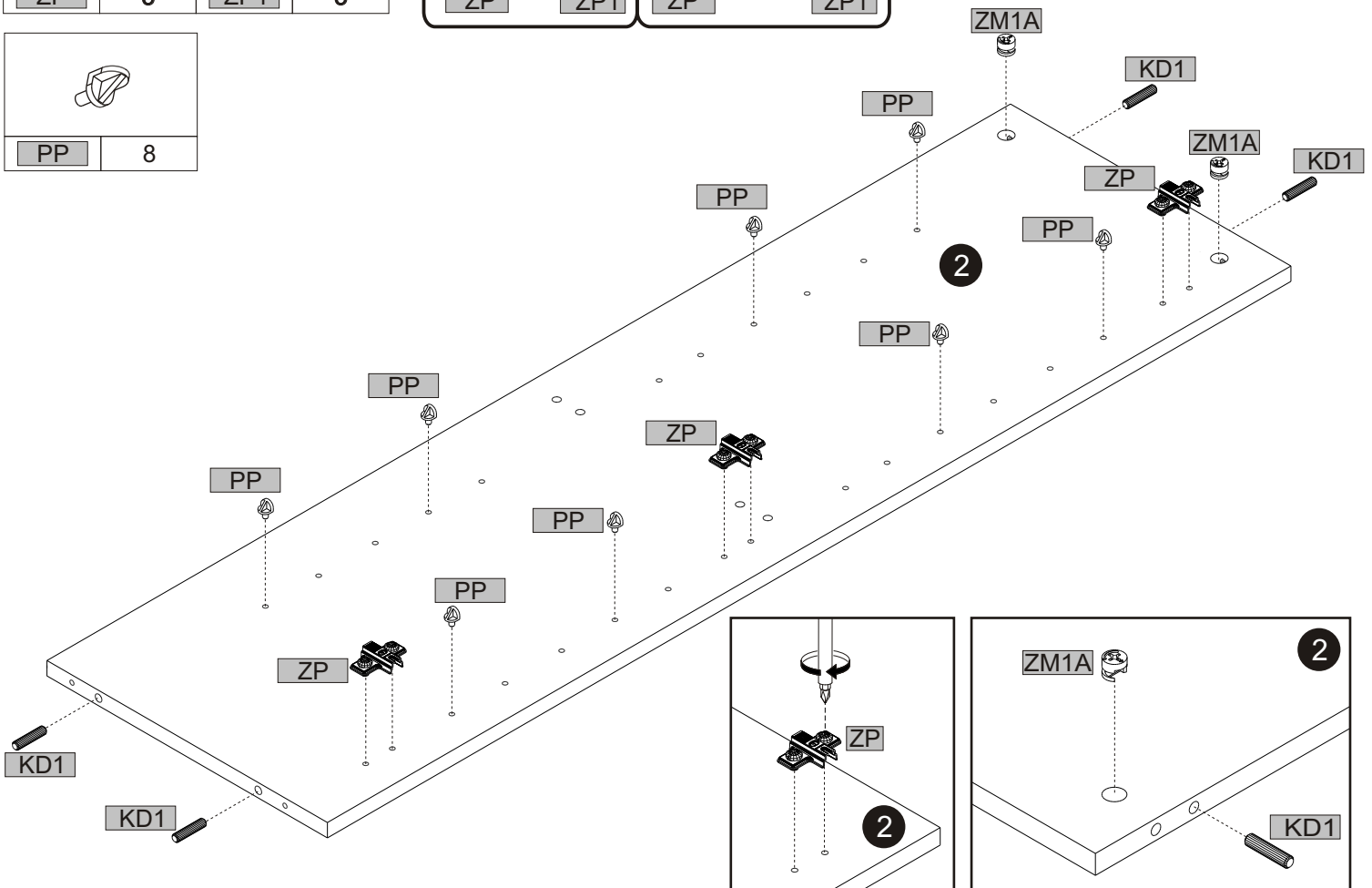
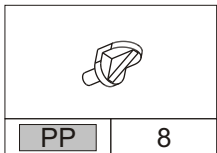
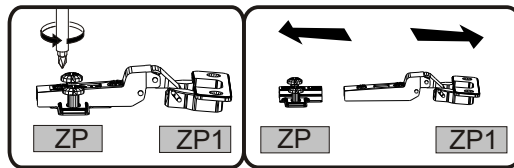
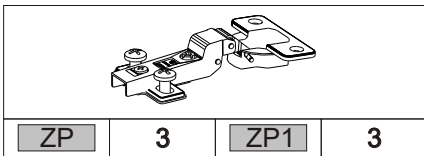
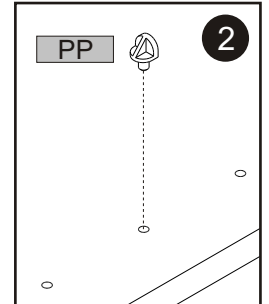

04

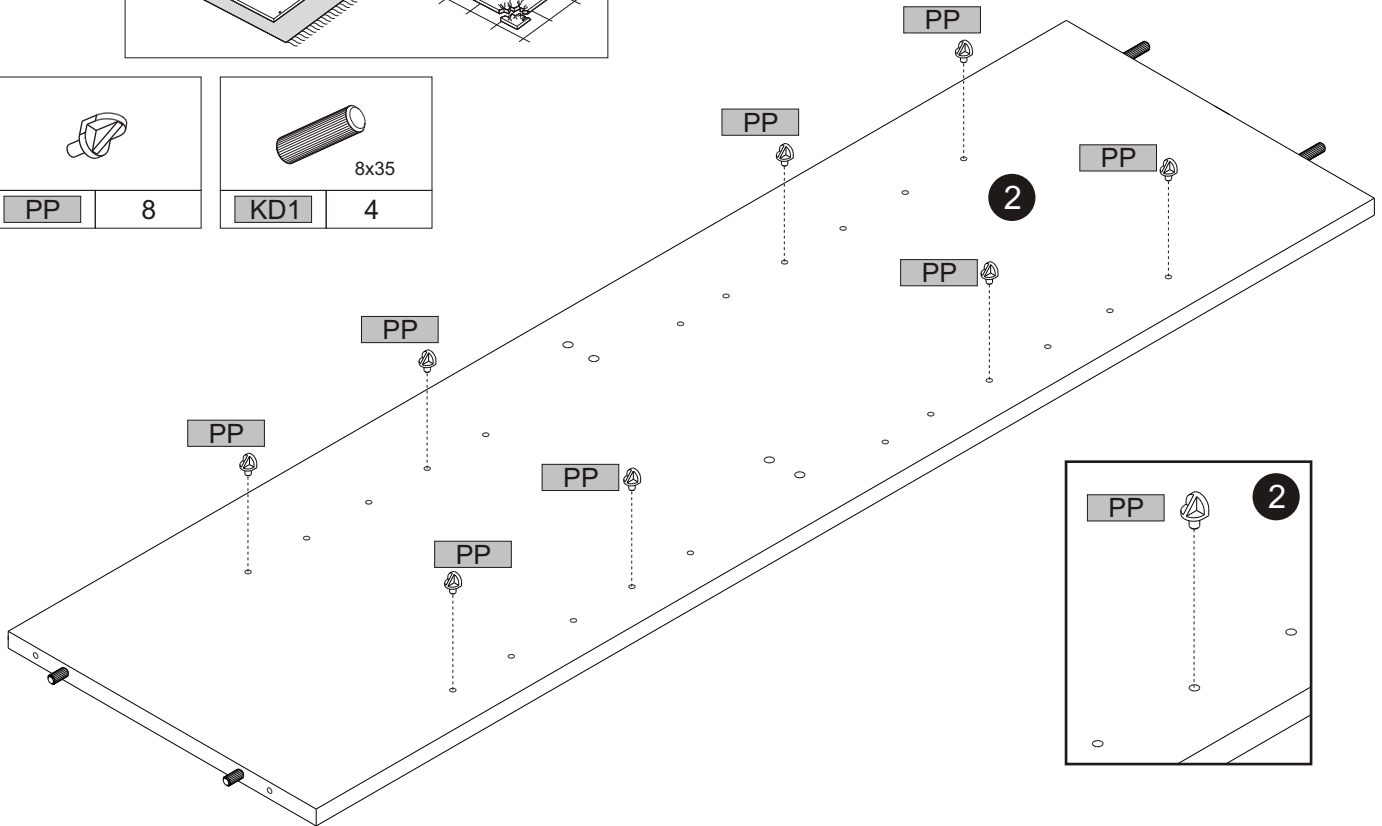
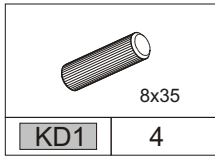
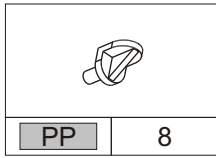
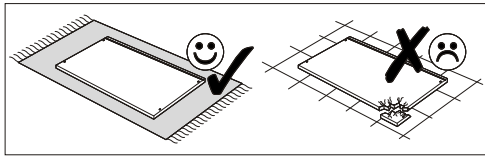

05

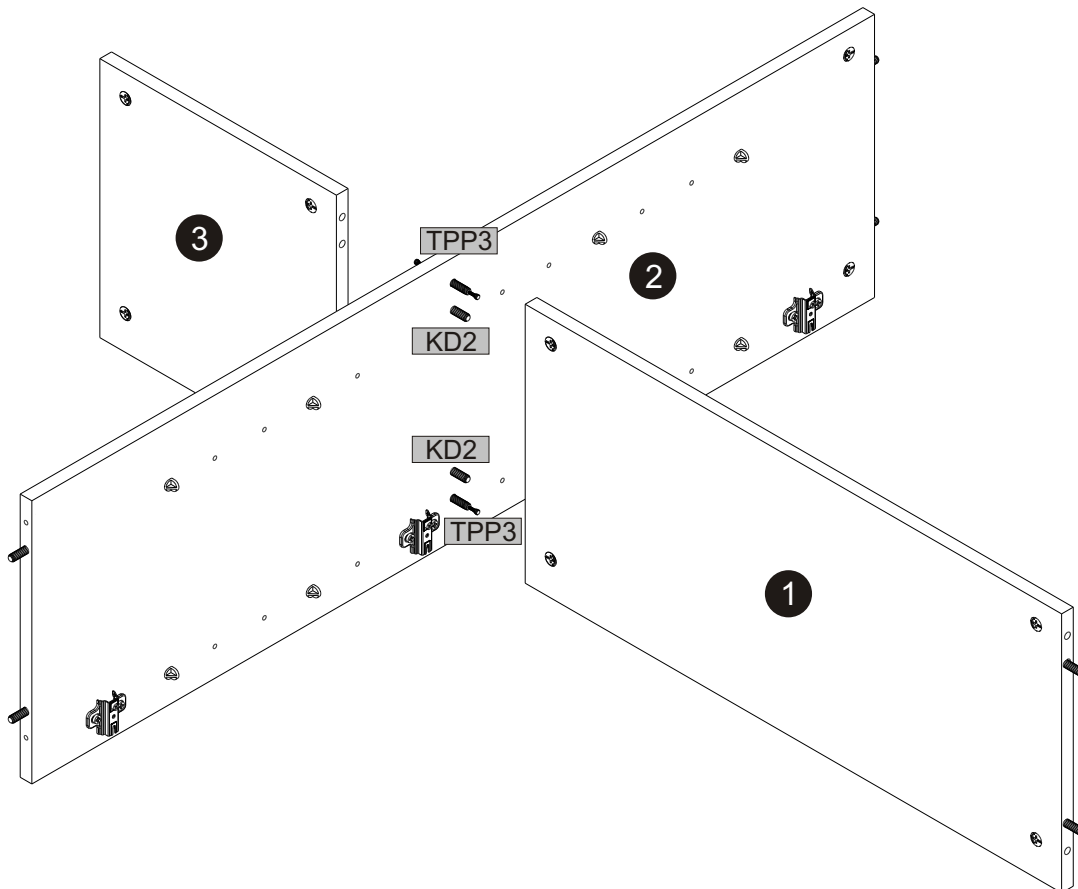
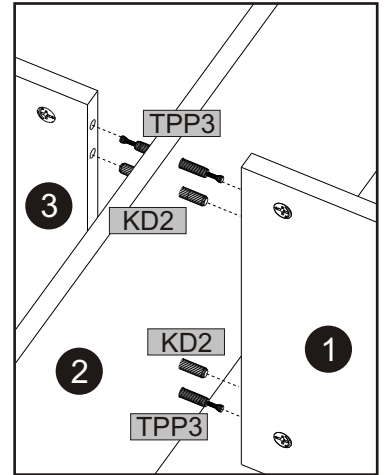
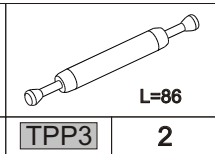
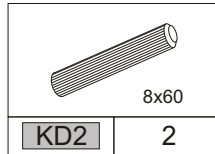
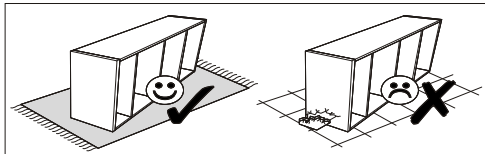

06

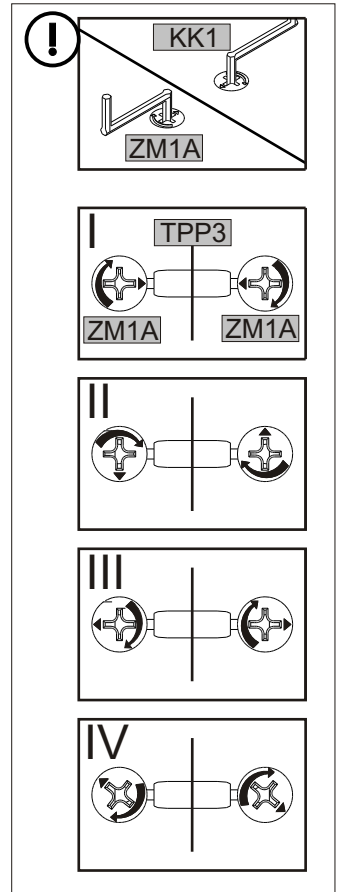
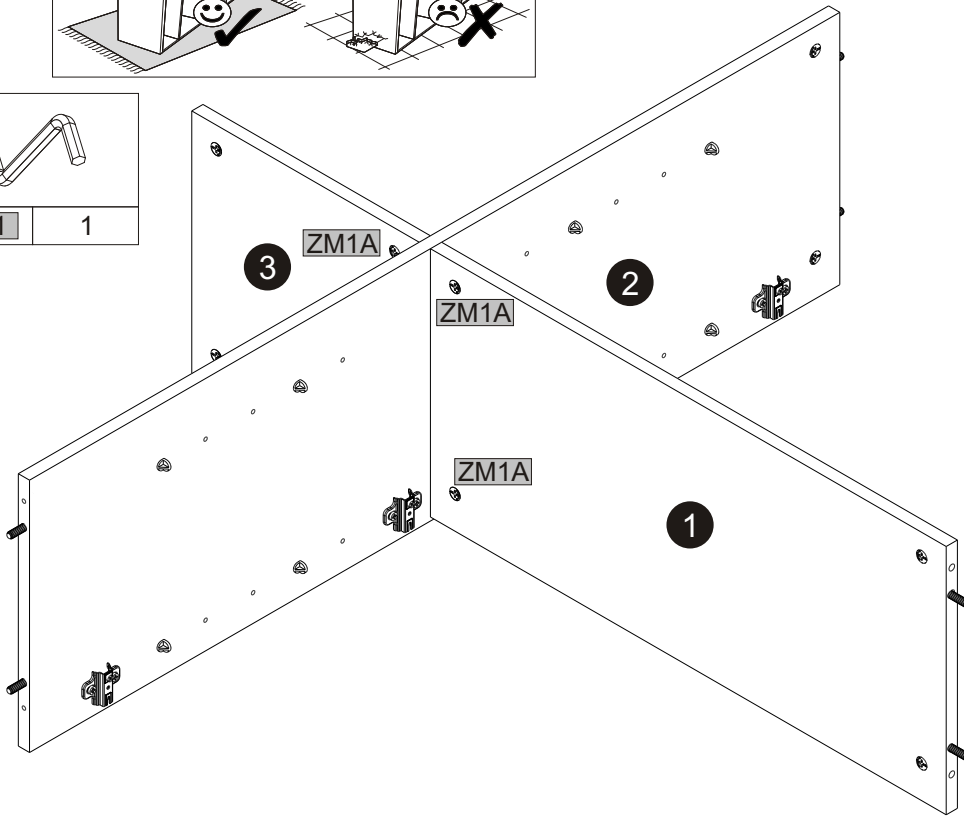
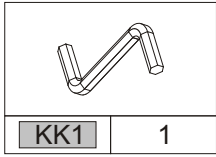
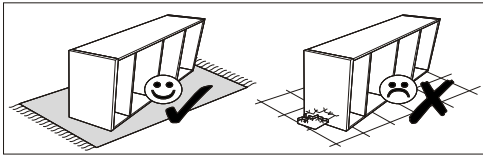

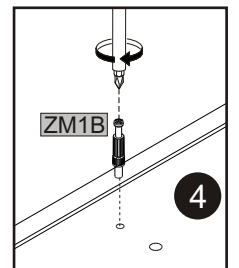
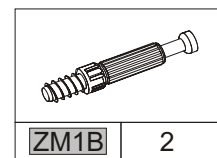
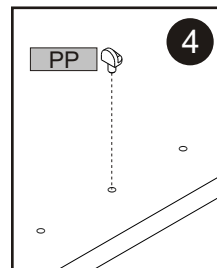
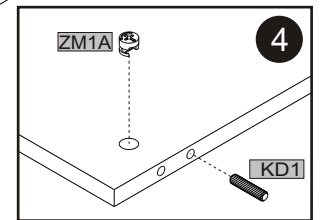
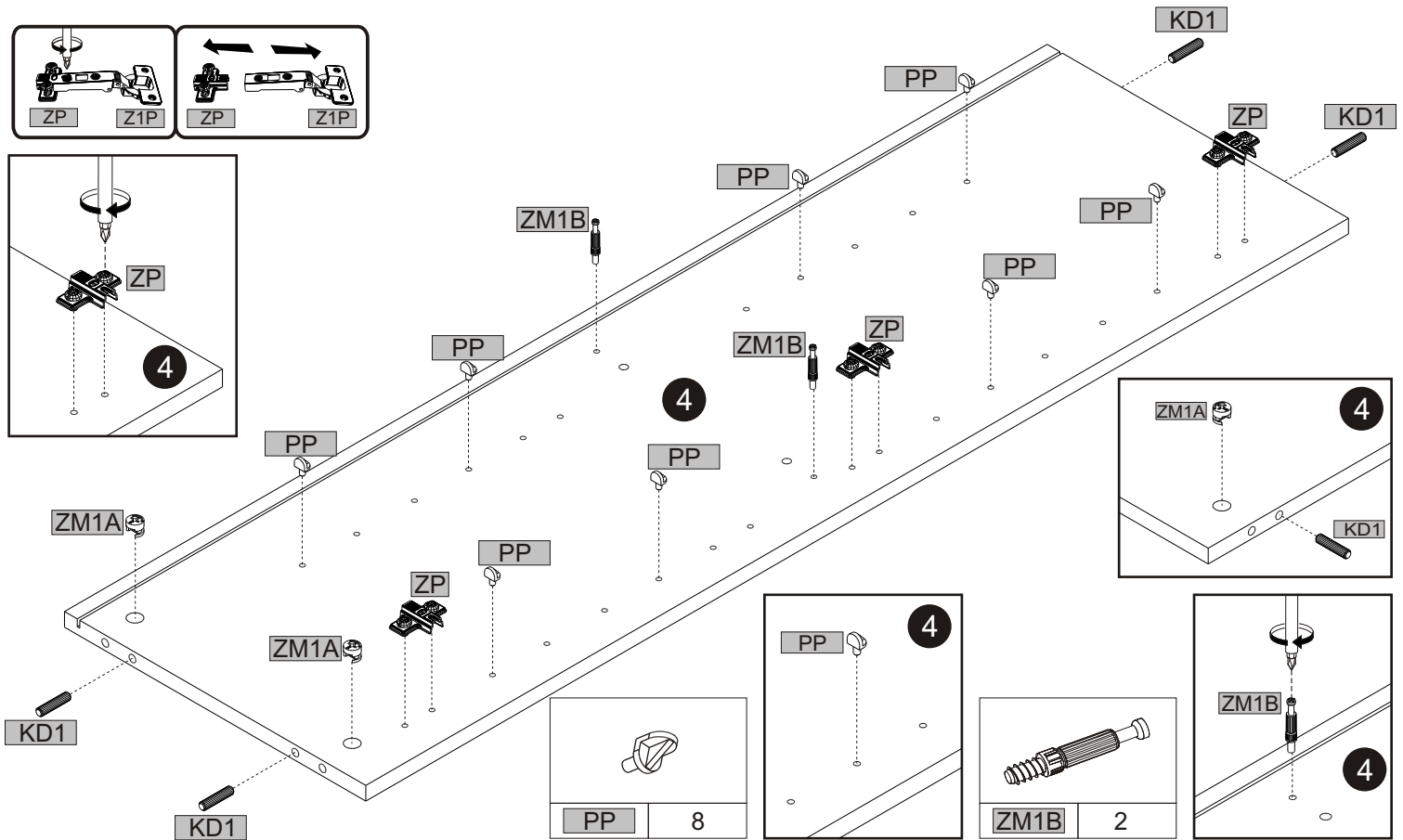
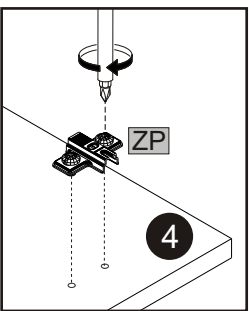
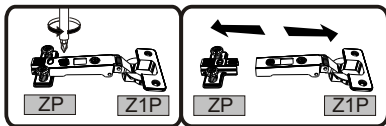
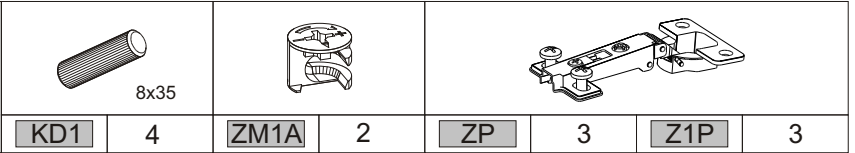
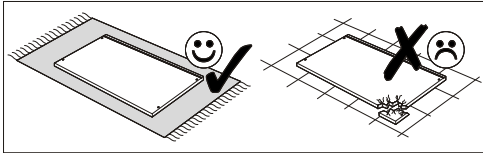

07

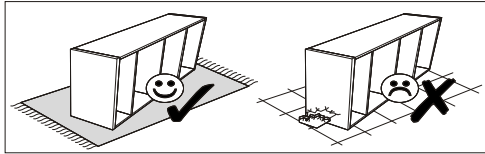

08

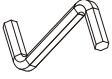

	1		8
---	---	--	---

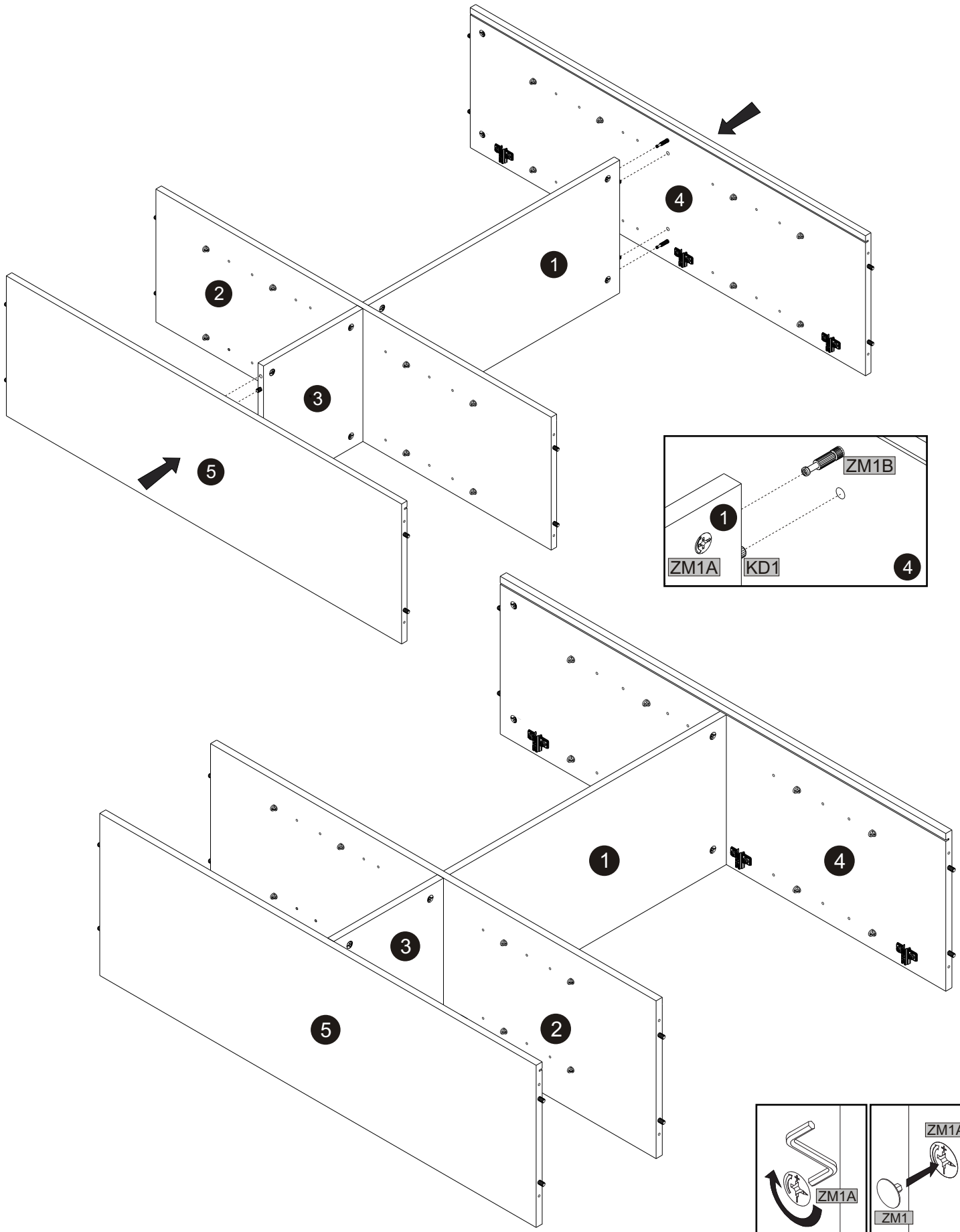

09

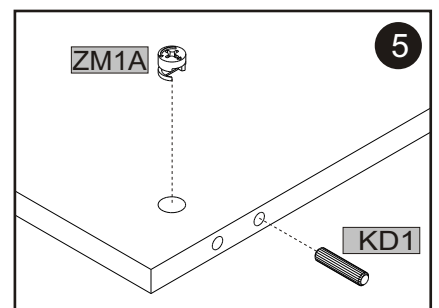
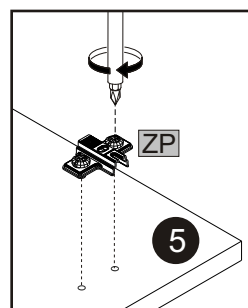
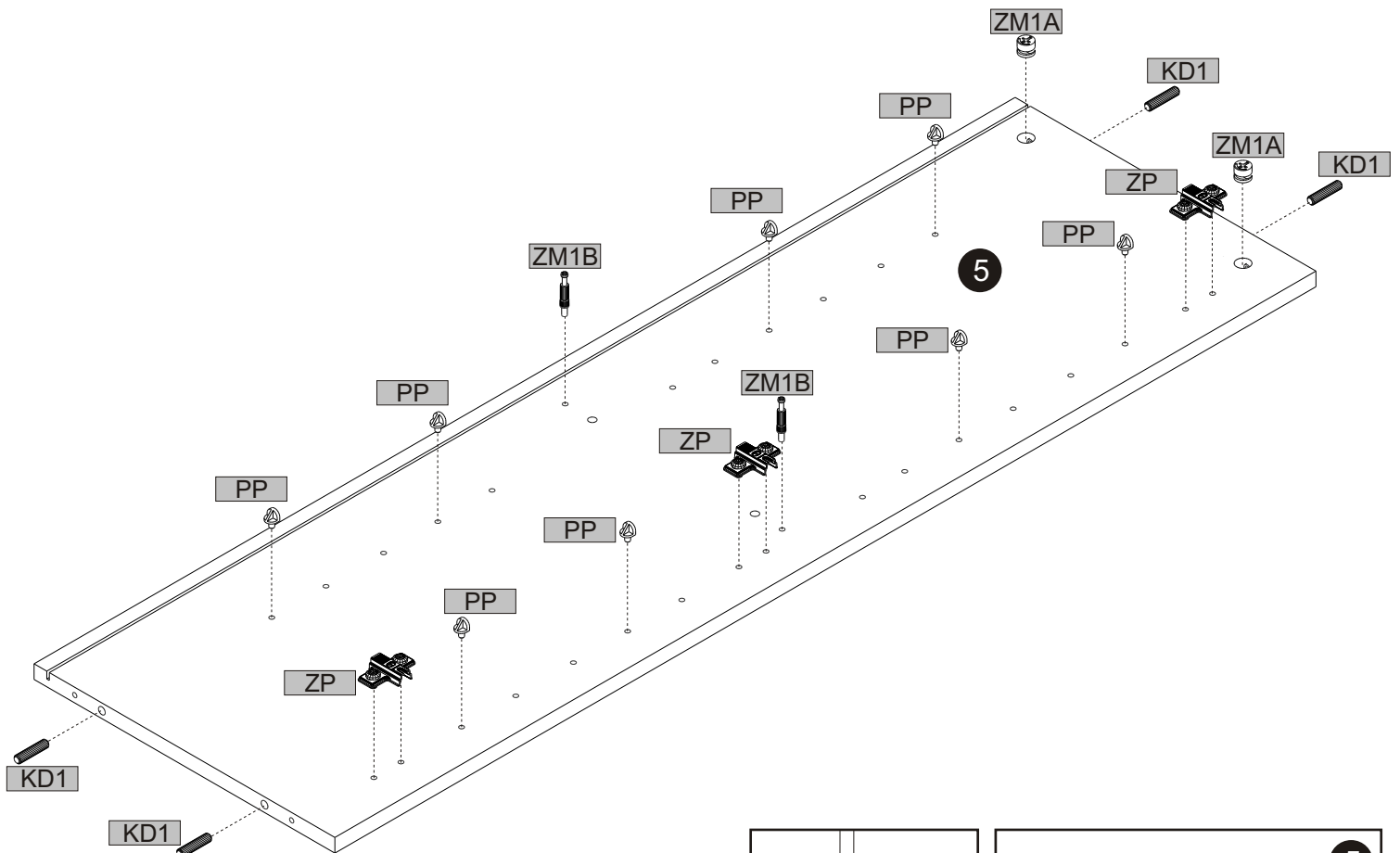
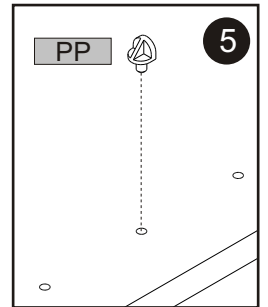
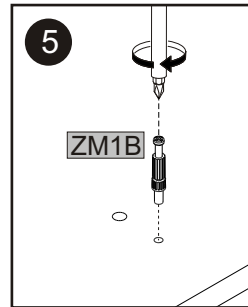
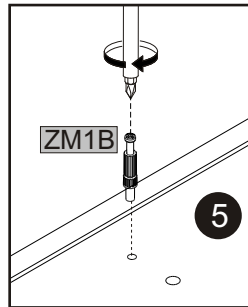
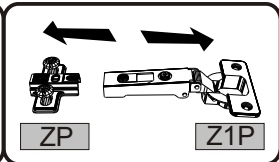
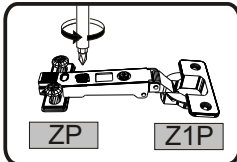
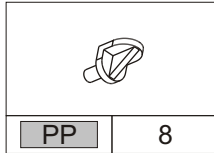
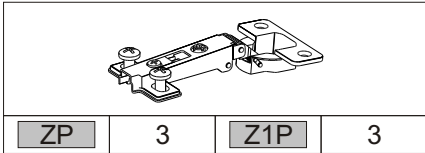
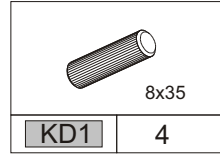
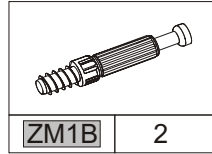
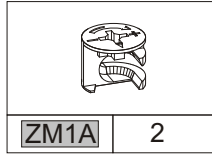
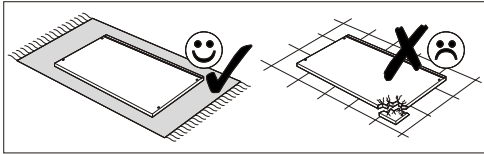

10

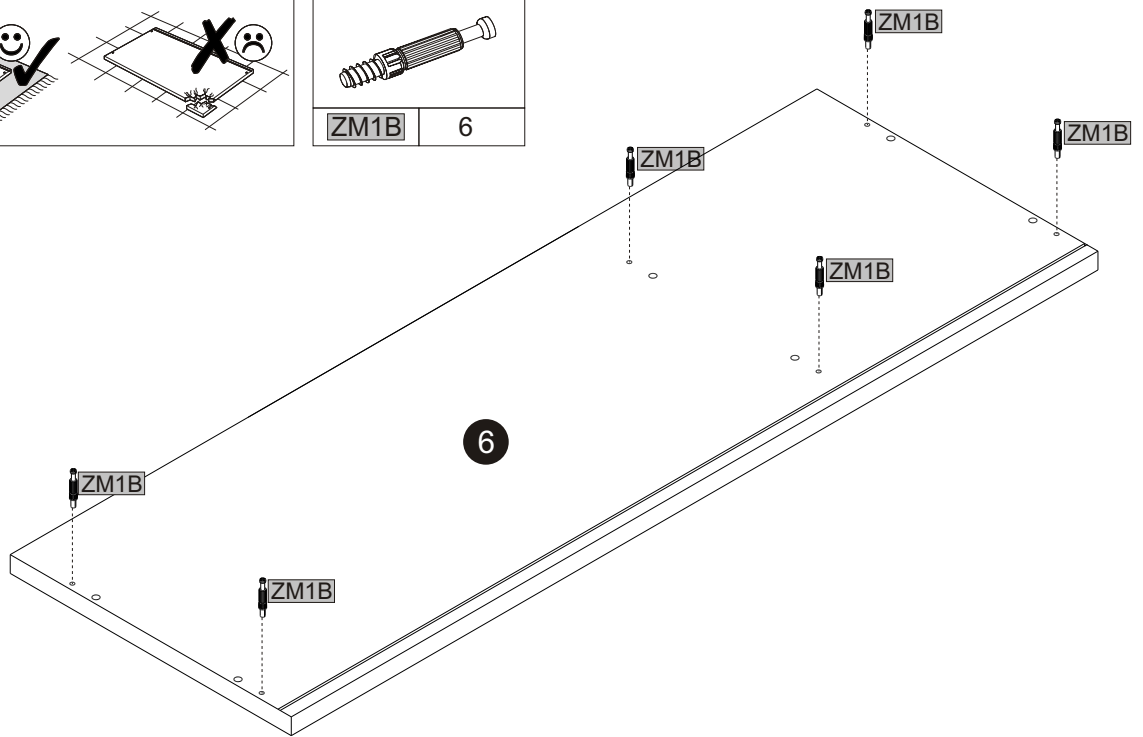
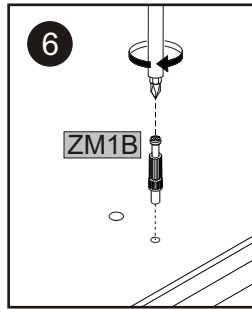
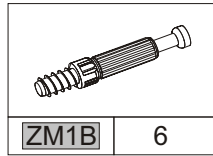
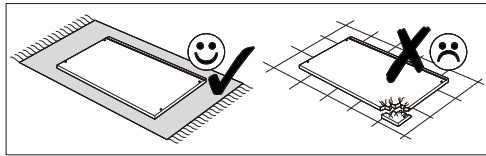

11

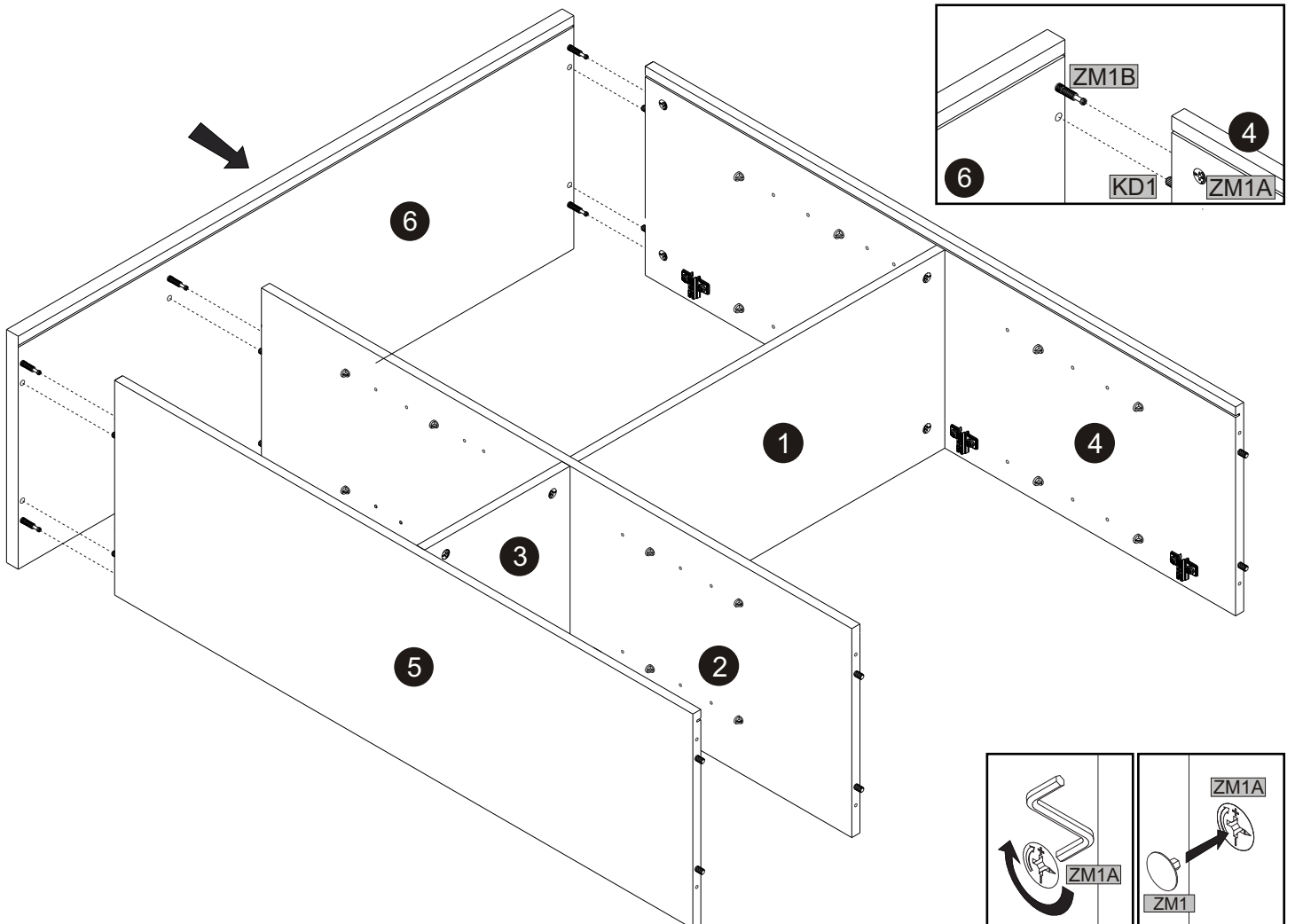
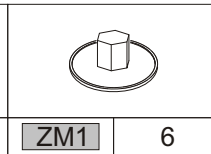
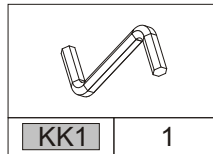
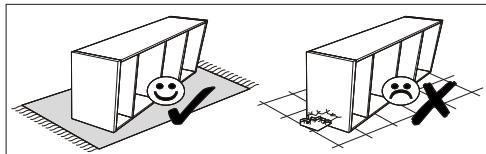

12

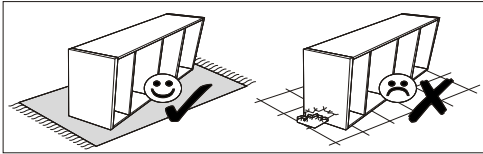

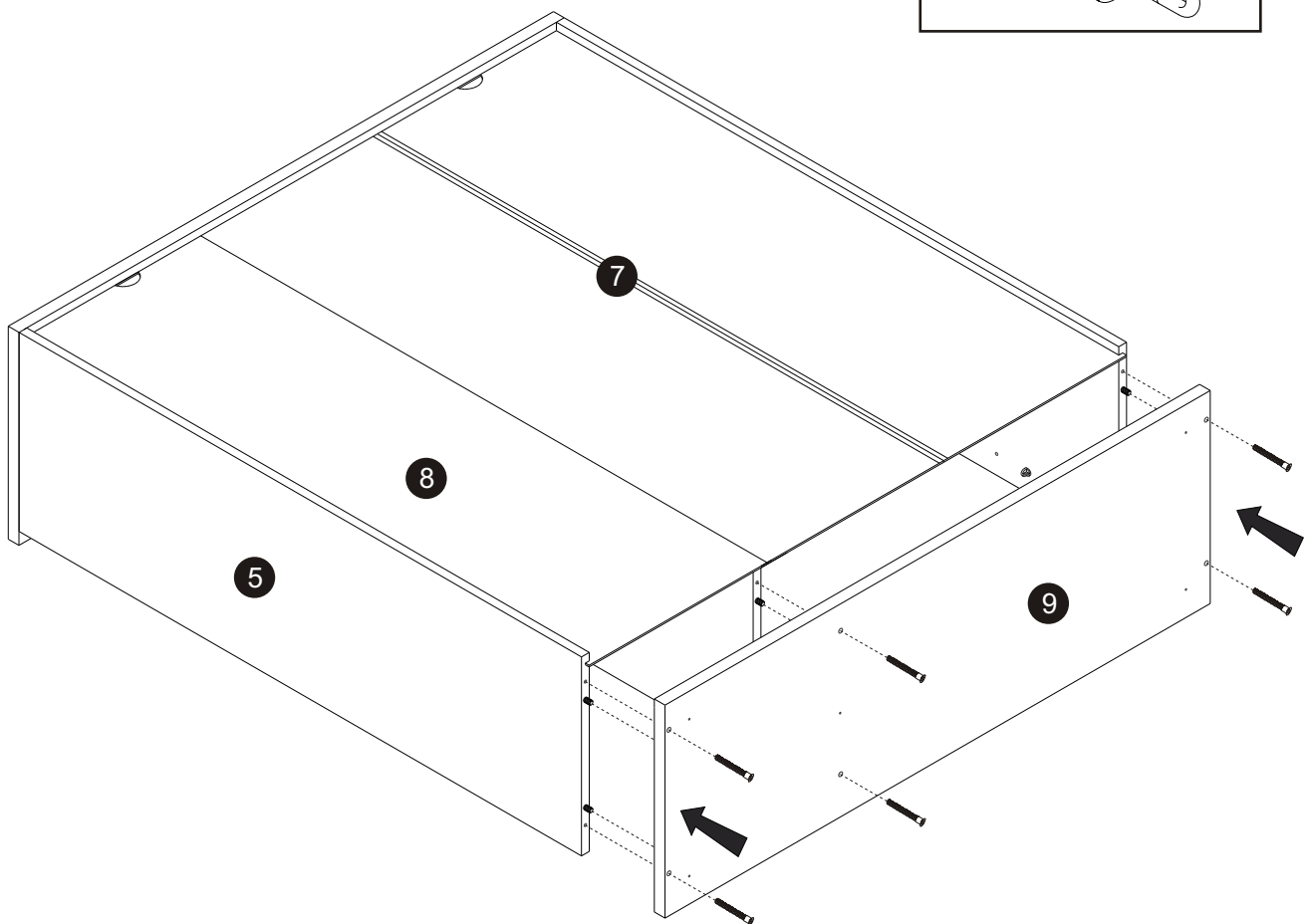
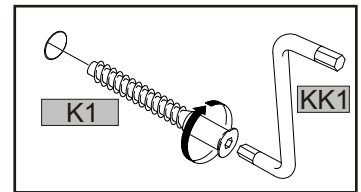
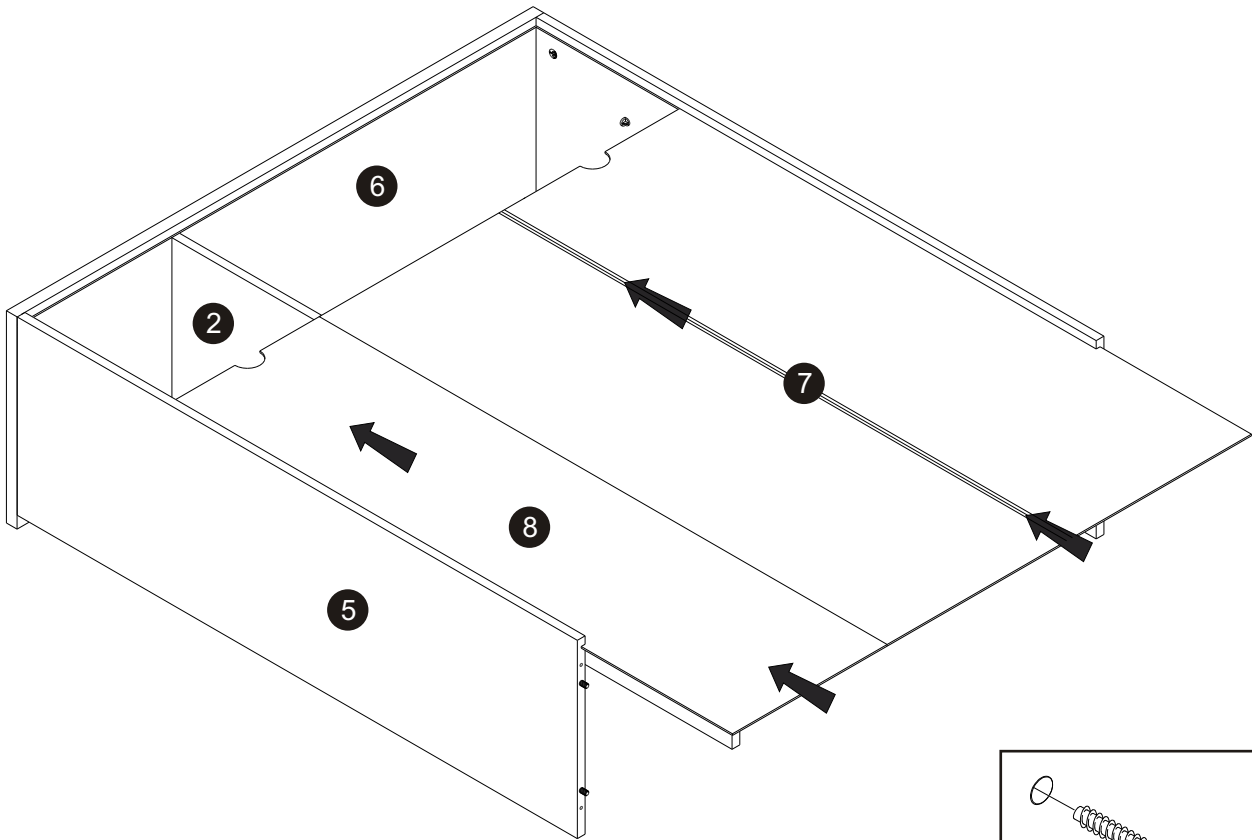

			7x50
KK1	1	K1	6

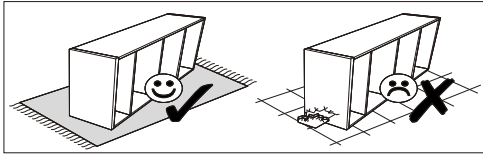

13



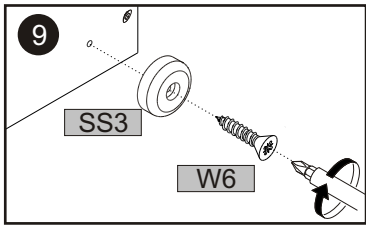
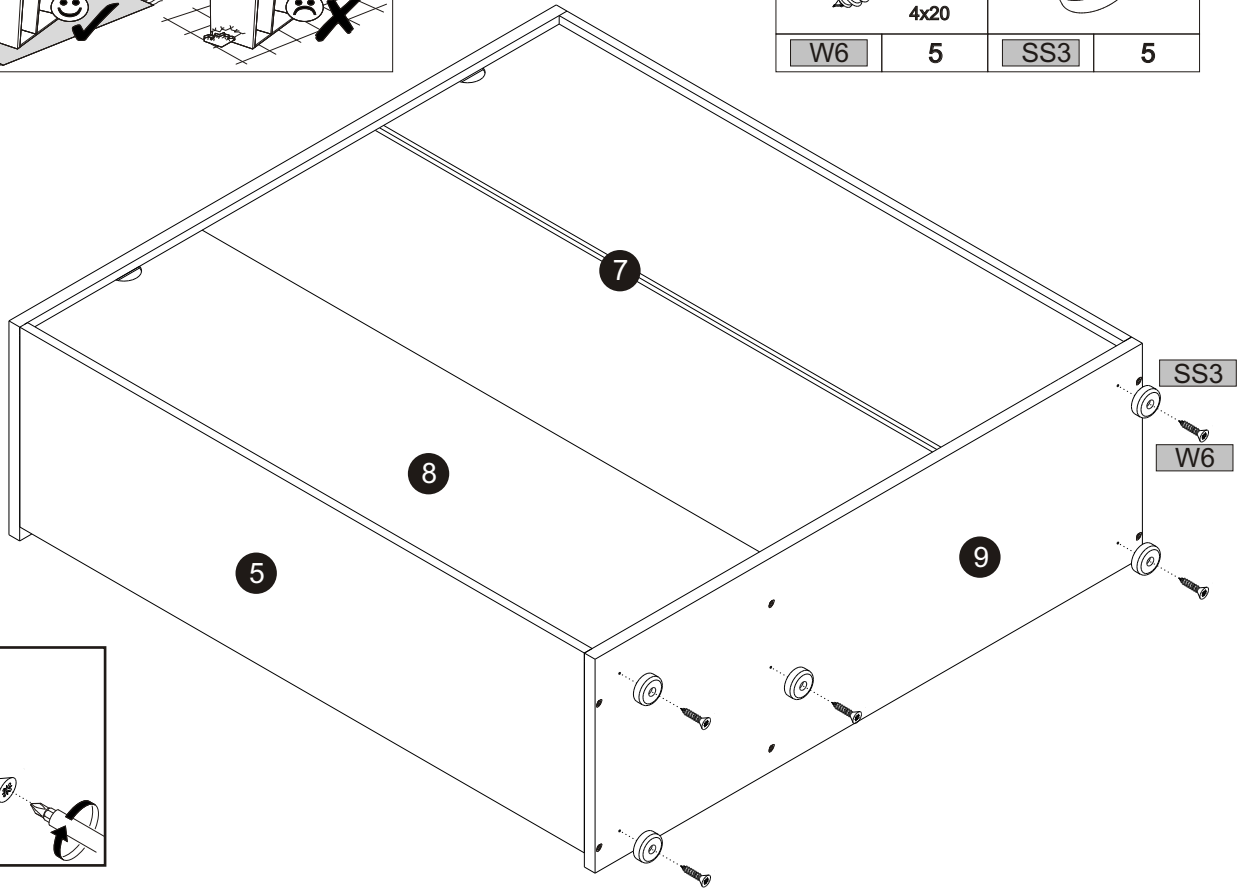

	4x20		
W6	5	SS3	5

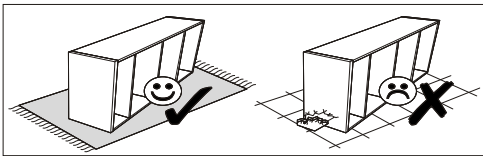

14

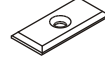

	3x16				
W1	15	PL1	9	S1	12

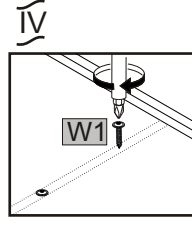
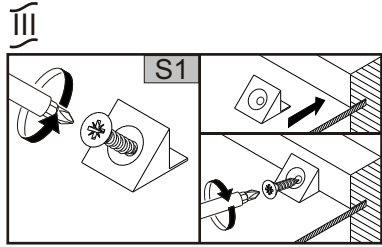
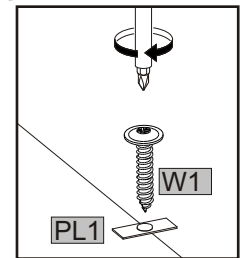
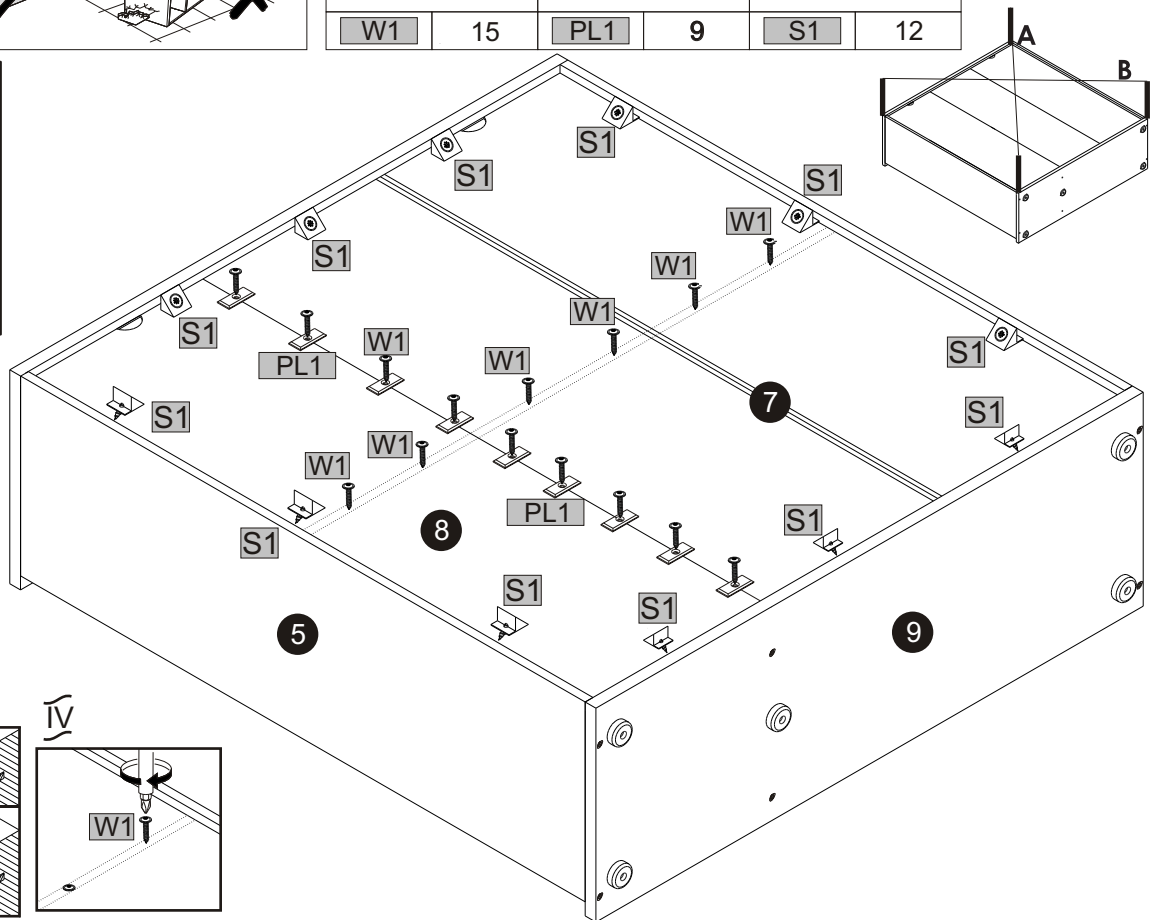
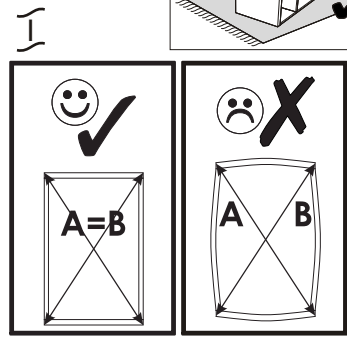

15

	2		2		4
KS1	2	KRW1	2	W11	4

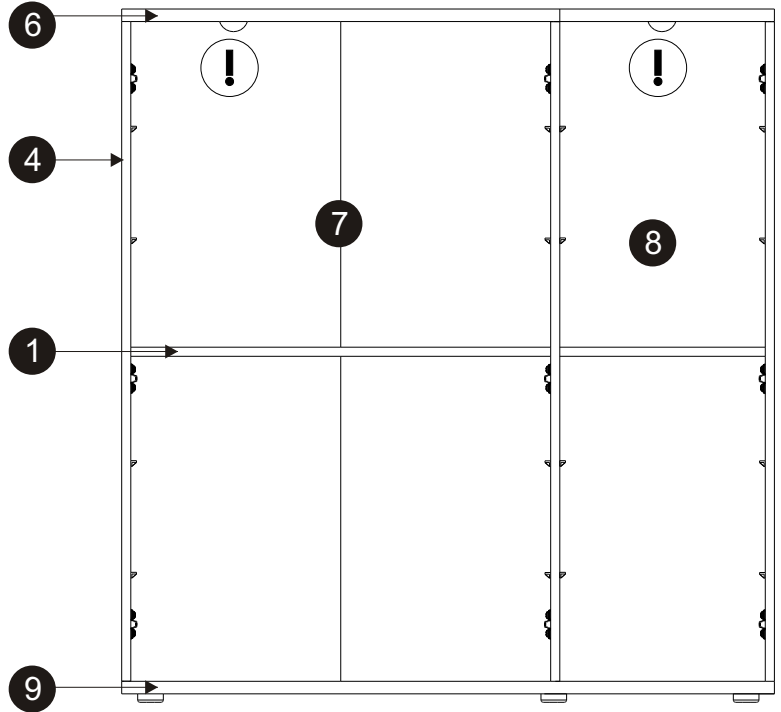

16

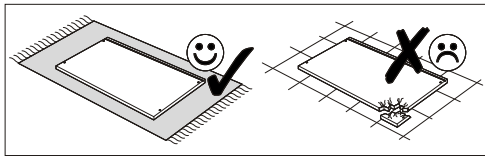

	6		3		6		4
W4	6	Z1P	3	KD2	6	TPP1	4

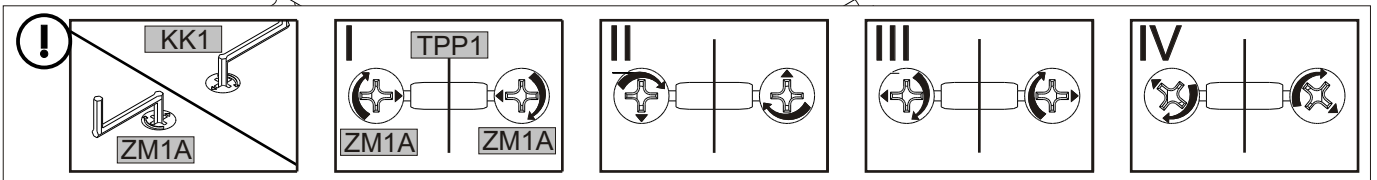
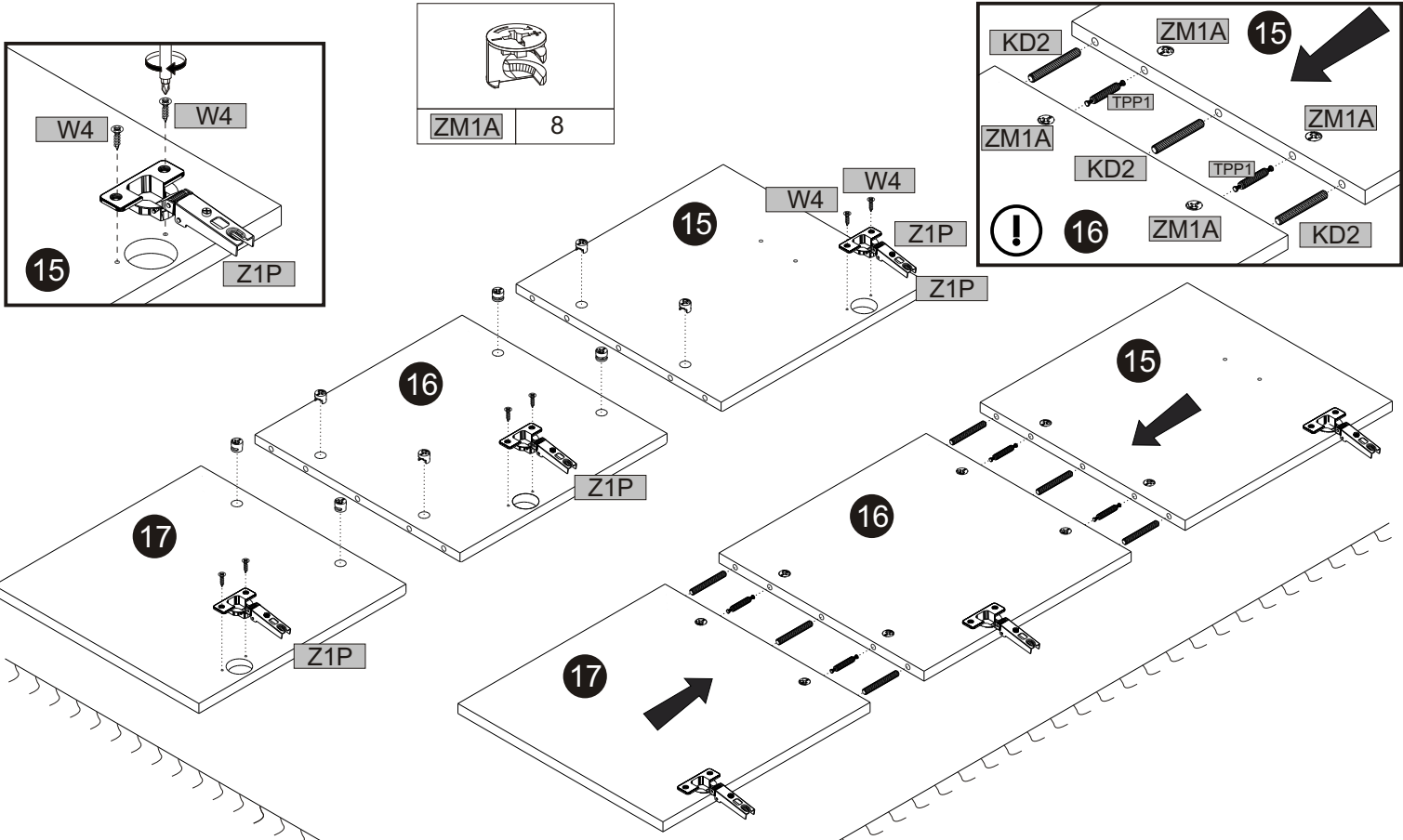

17

		4x13		8x60	L=48
		W4	ZM1A	KD2	TPP1
		6	8	6	4

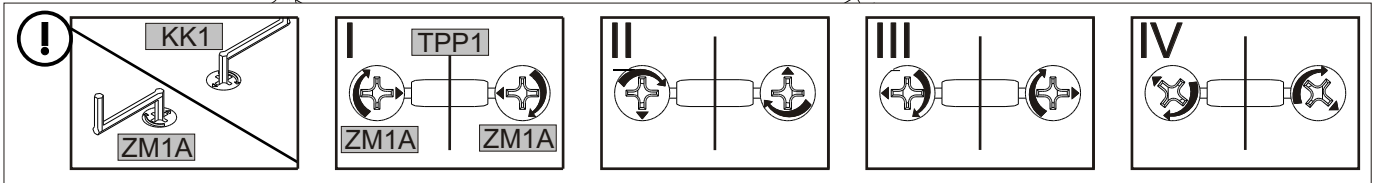
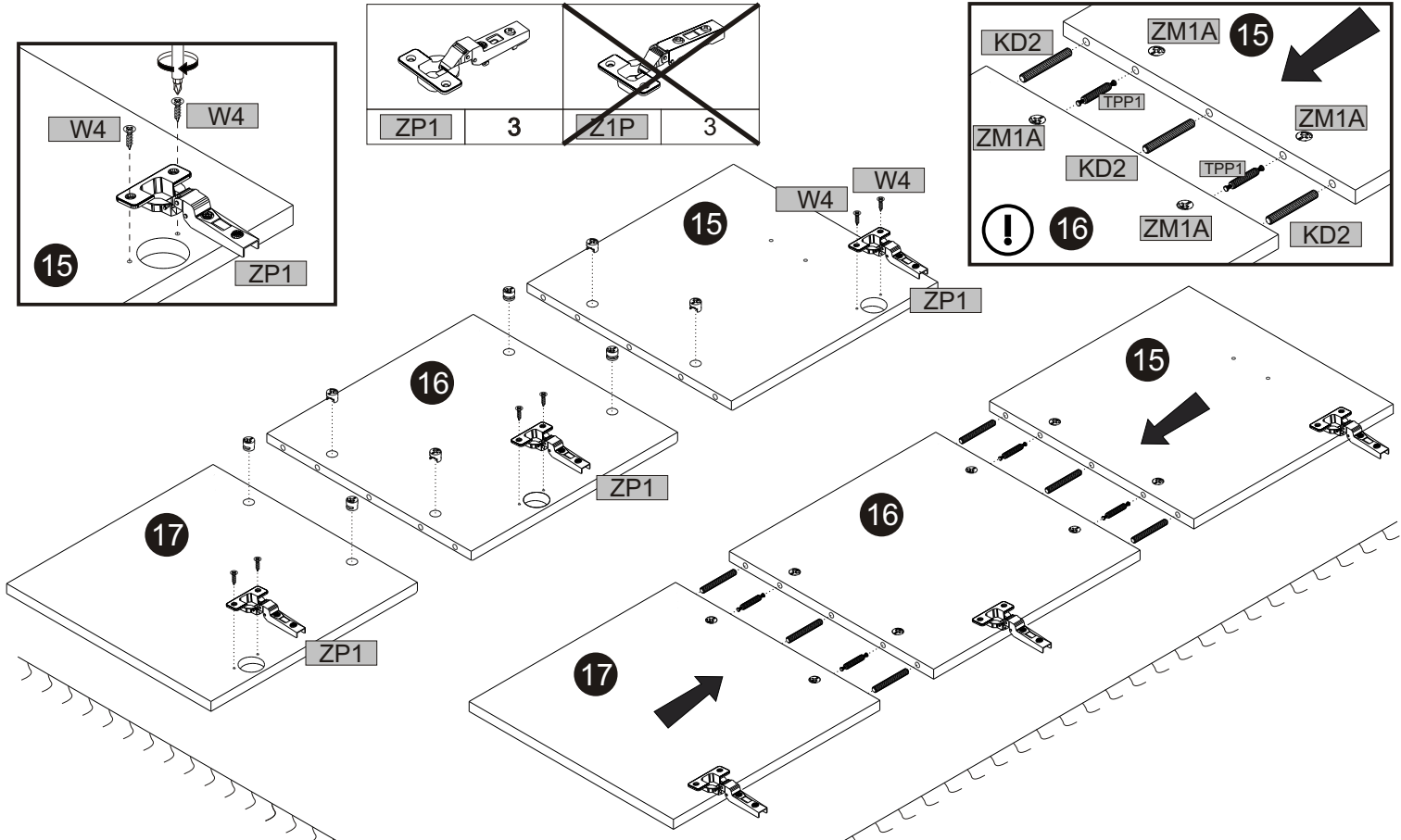

18

		ZM1	ZM1
		8	8

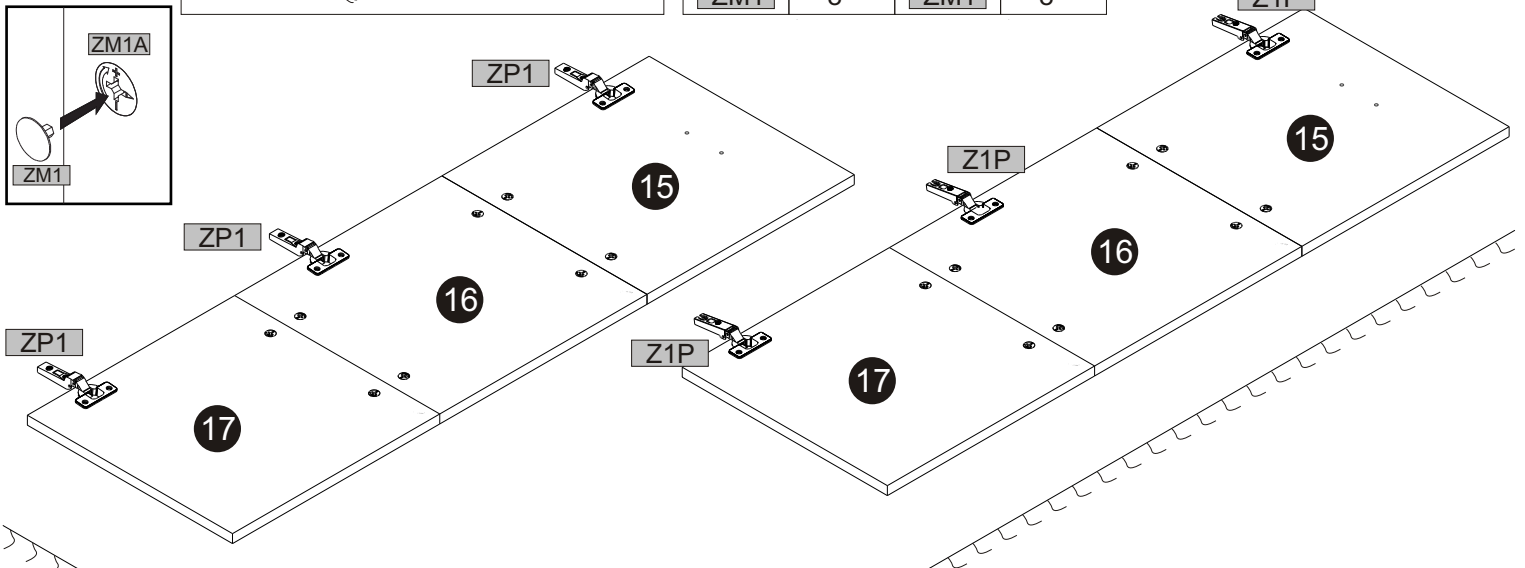

19

W4	6	Z1P	3	KD2	6	TPP1	4

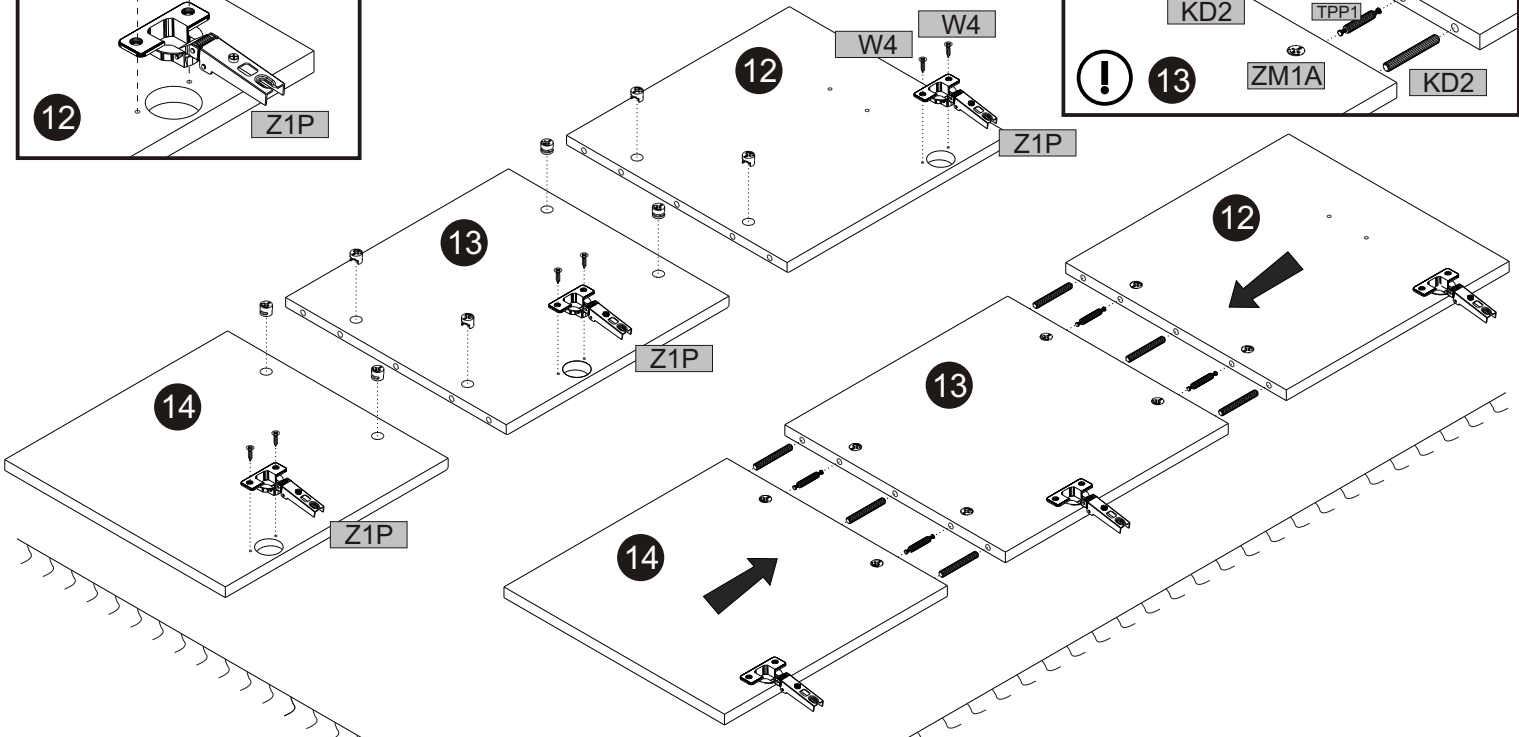
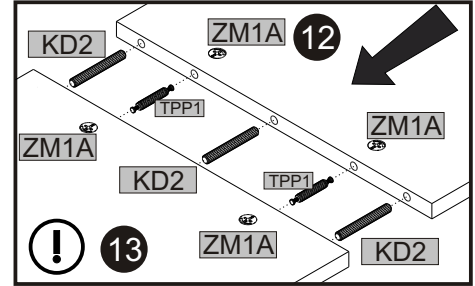
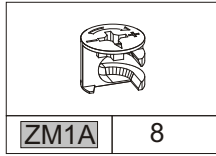
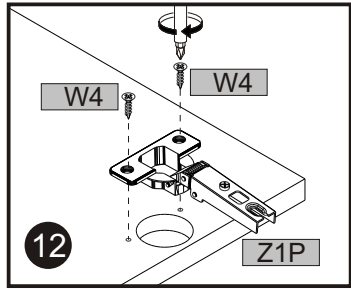

--	--	--	--	--	--

20

ZM1	4	ZM1	4

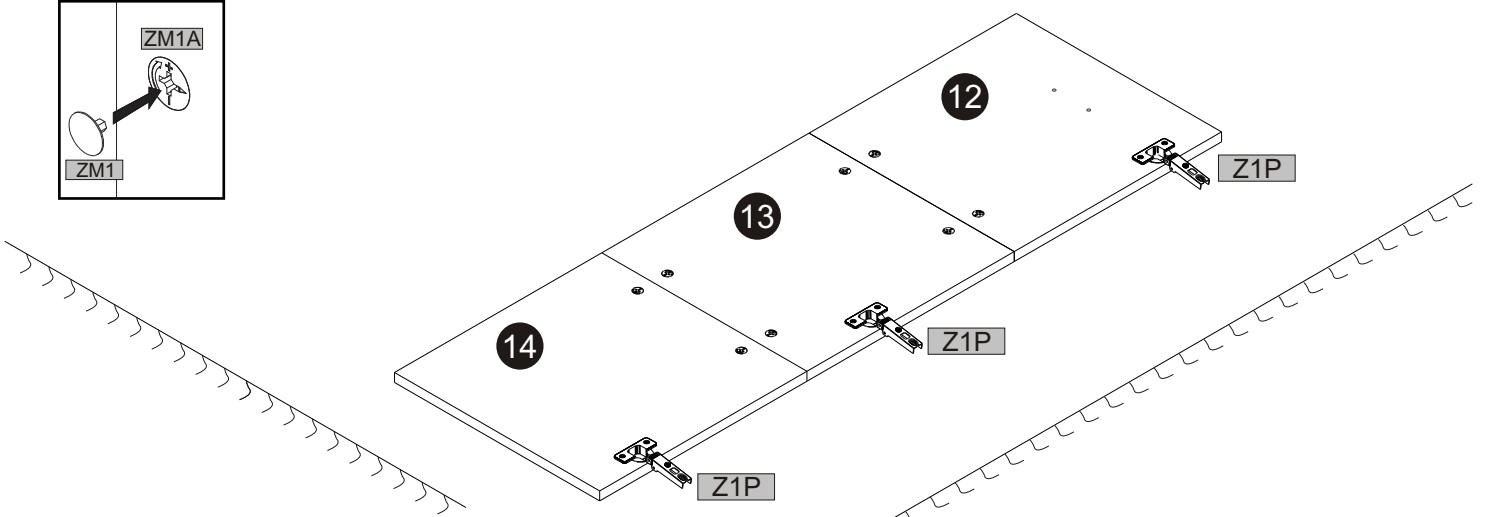
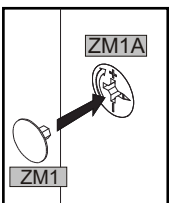

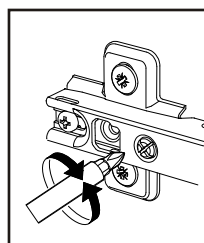
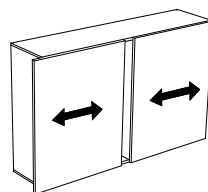
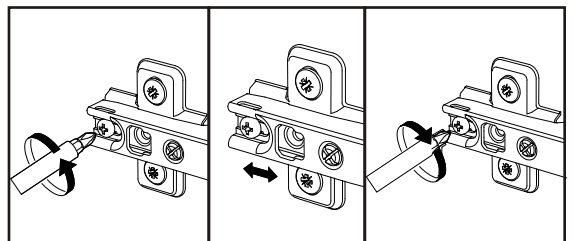
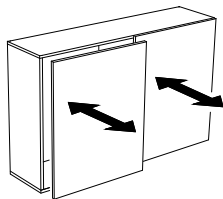
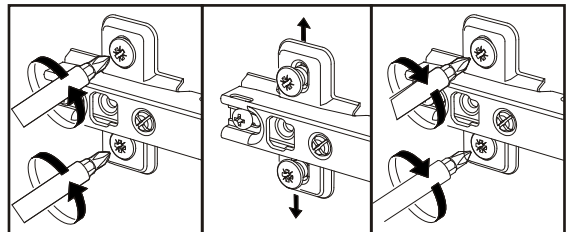
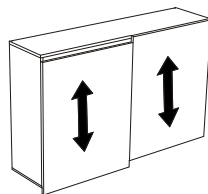
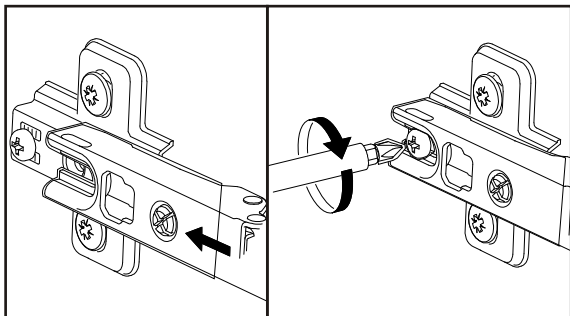
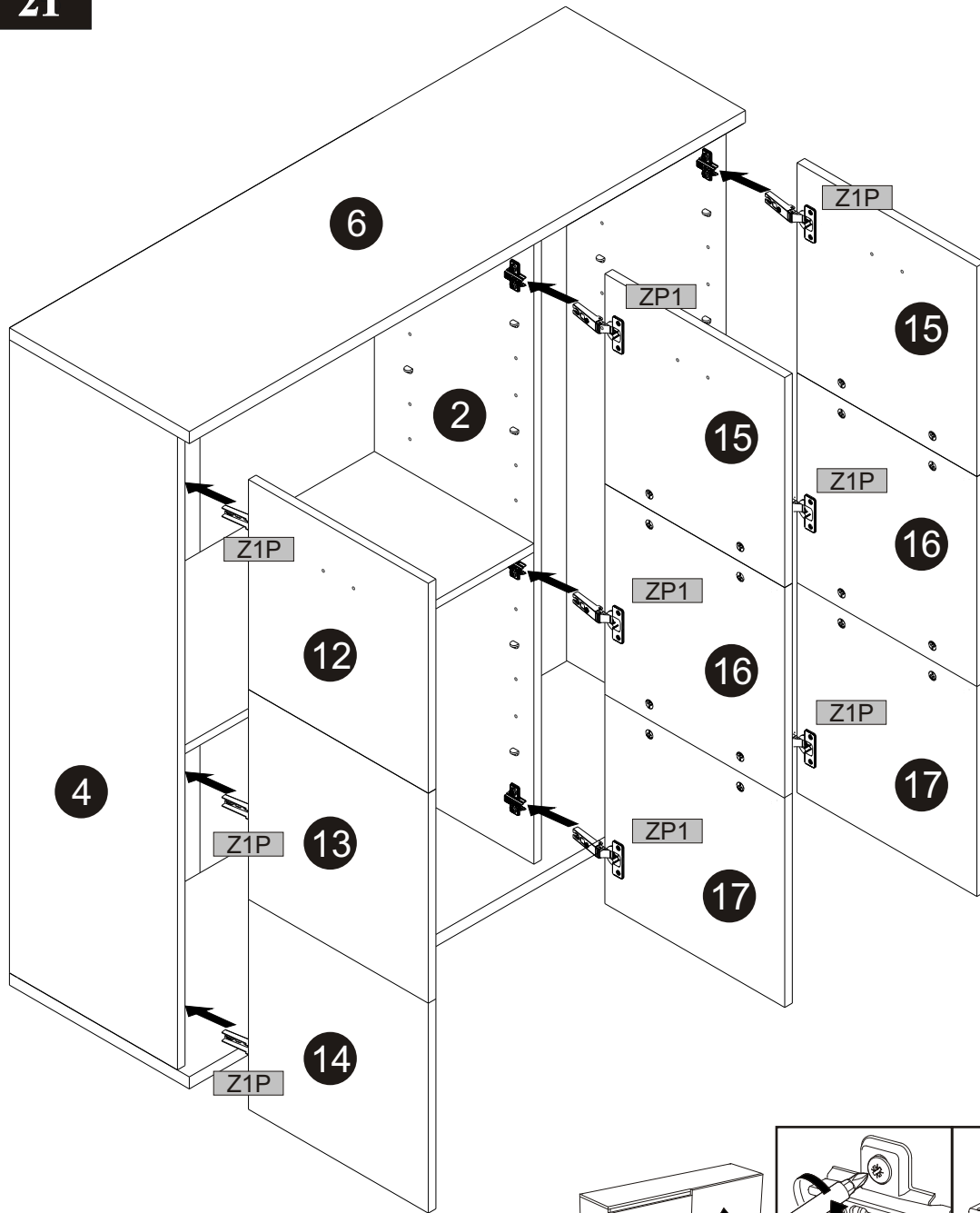

21

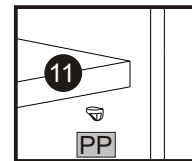
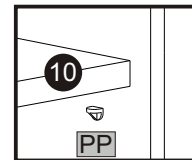
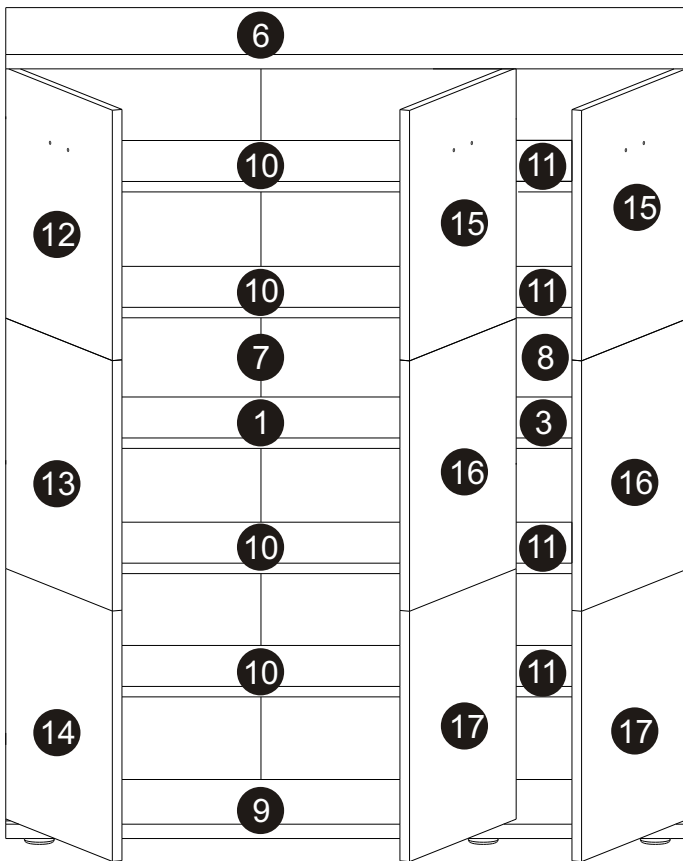

22

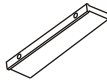

23

			
U99	3	WU	6

3,5x27

