

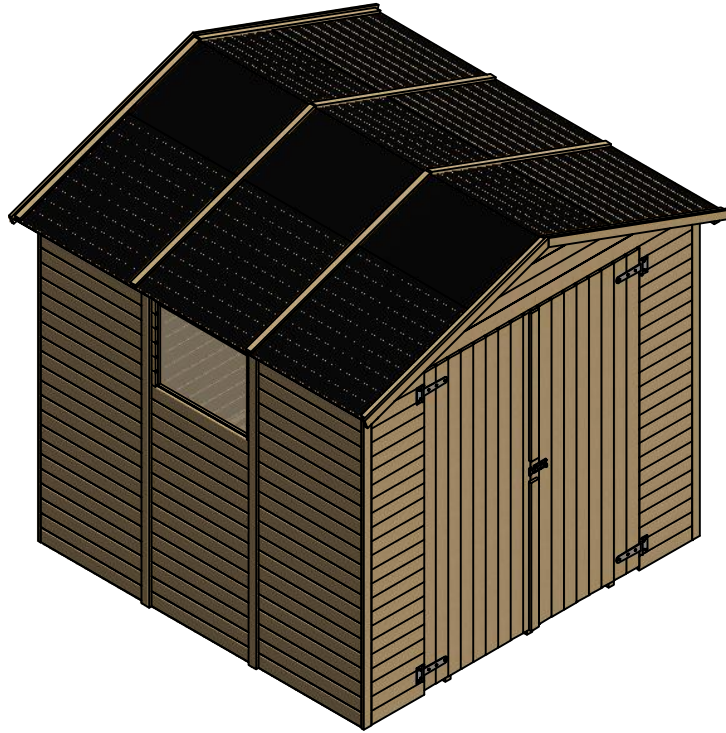

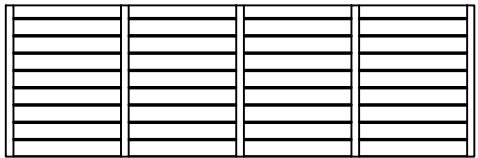







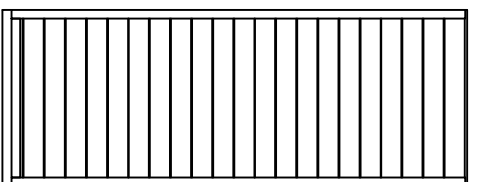
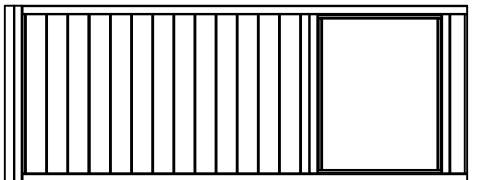

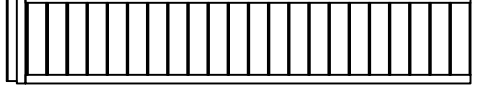
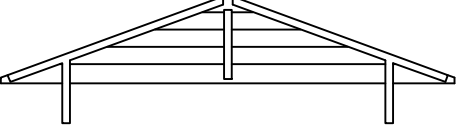
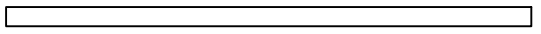
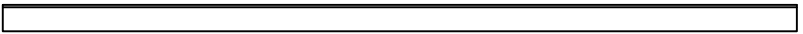
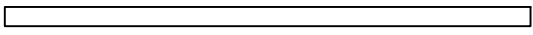

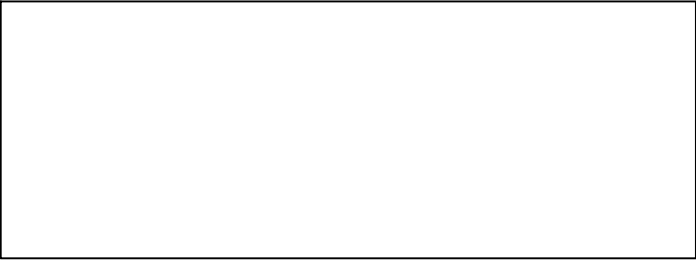
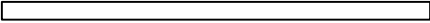

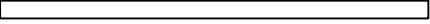
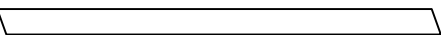
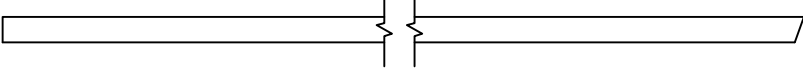
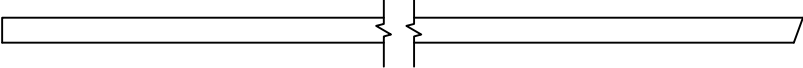

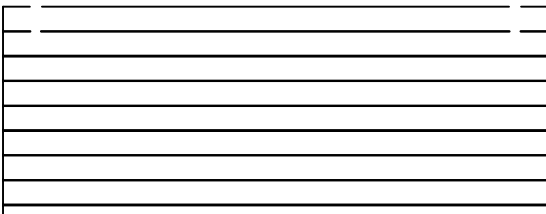
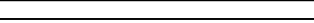
2400x2330xH2160
(2200x2130)

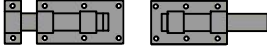

NR	DIMENSION	PCS	PHOTO
A	2170x700x50	3	
B	35x35x400	6	
C	50x700x1830	8	
D	50x700x1830	1	
E	50x360x1830	1	
F	50x360x1830	1	
G	50x2100x410	2	
H	15x50x1380	1	
J	45x70x2100	1	
K	35x35x1096	4	

NR	DIMENSION	PCS	PHOTO
L	35x35x1150	4	
M	10x623x2300	4	
N	15x35x1150	4	
O	1000x2300	3	
P	15x35x1250	8	
R	15x50x1280	4	
S	15x50x2080	2	
T	15x50x1835	4	
U	15x50x1780	4	
W	50x700x1810	2	
Y	15x50x880	2	
I	4,0 x 15	6	
II	4,0 x 25	176	
III	4,0 x 35	42	
IV	4,0 x 45	26	
V	4,0 x 55	81	
VI	4,0 x 90	8	
VII	100x40	1+1	
VIII	HINGE 300x90	4	

III - 4,0x35 #24 

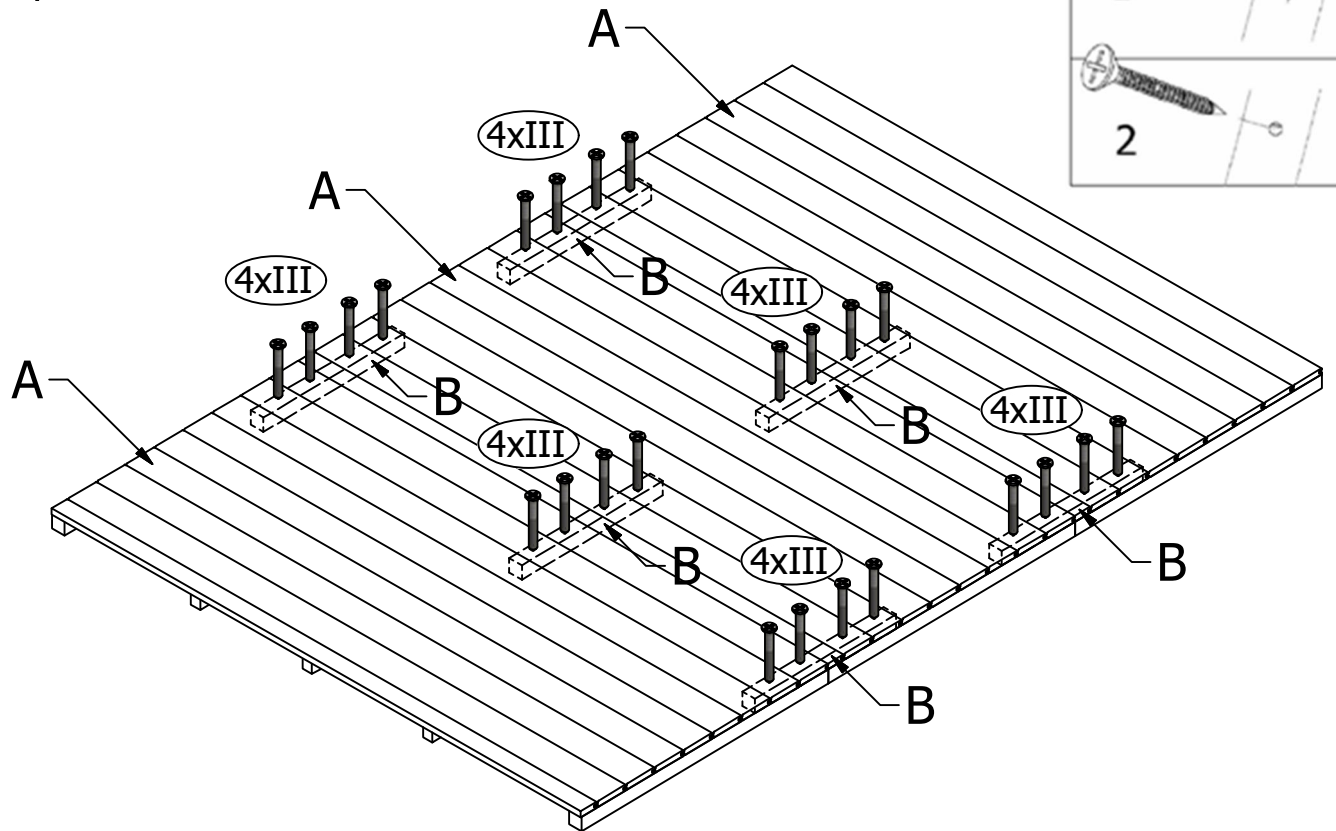
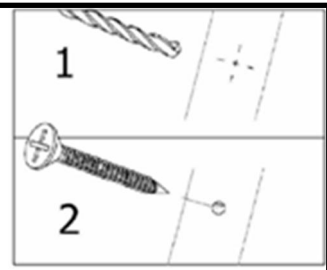

V - 4,0x55 #42 

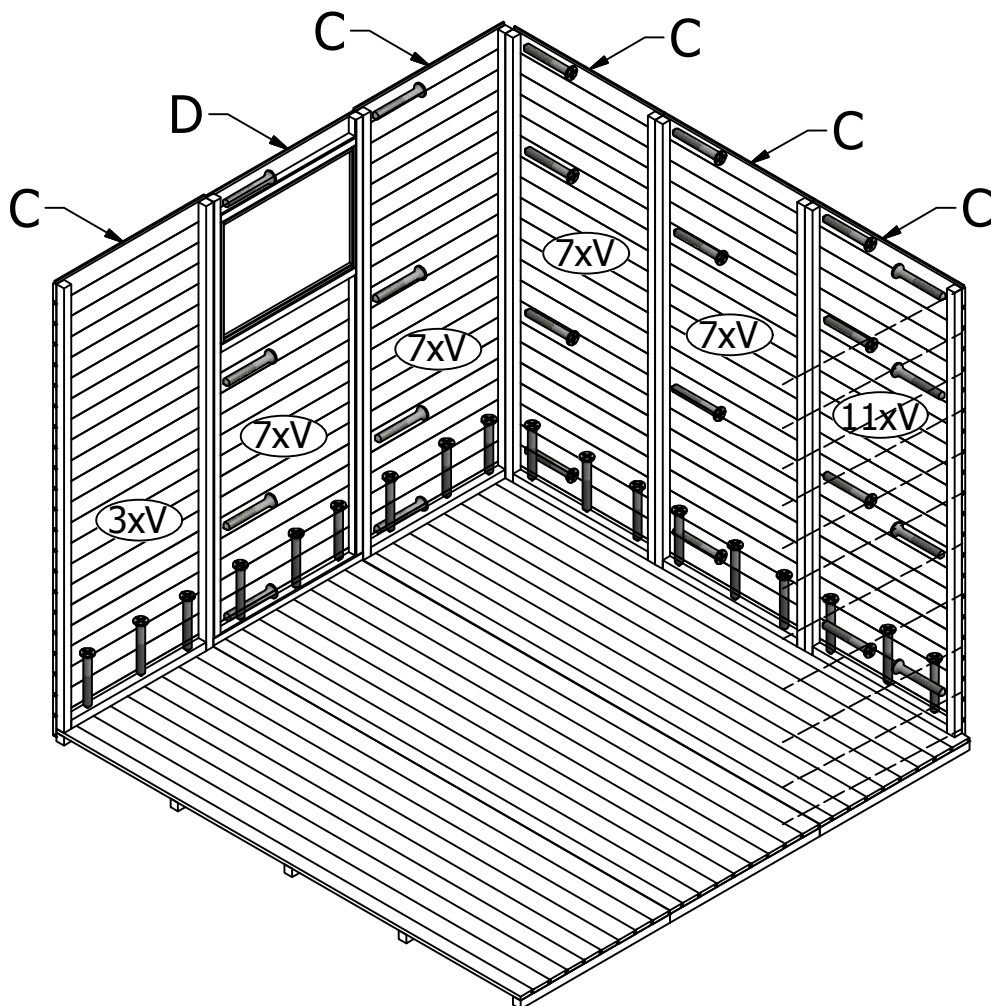

V - 4,0x55 #29

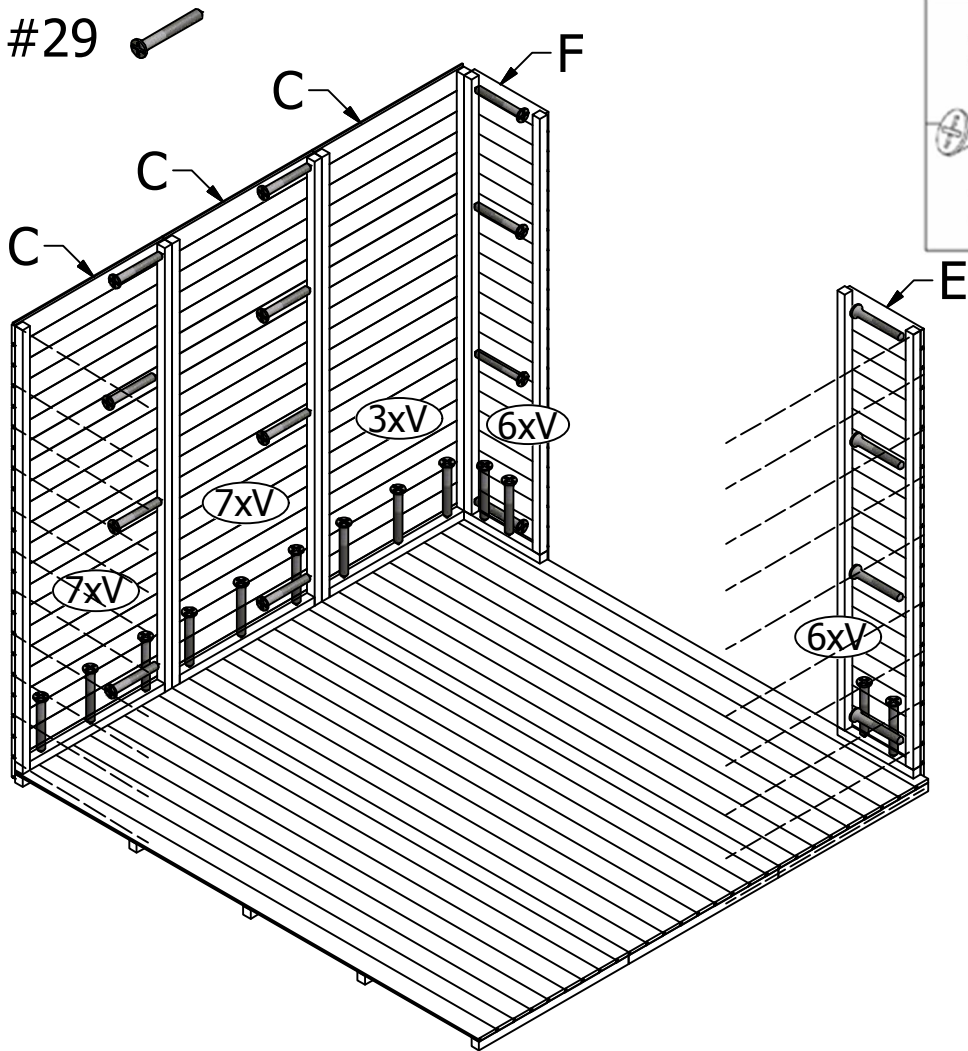

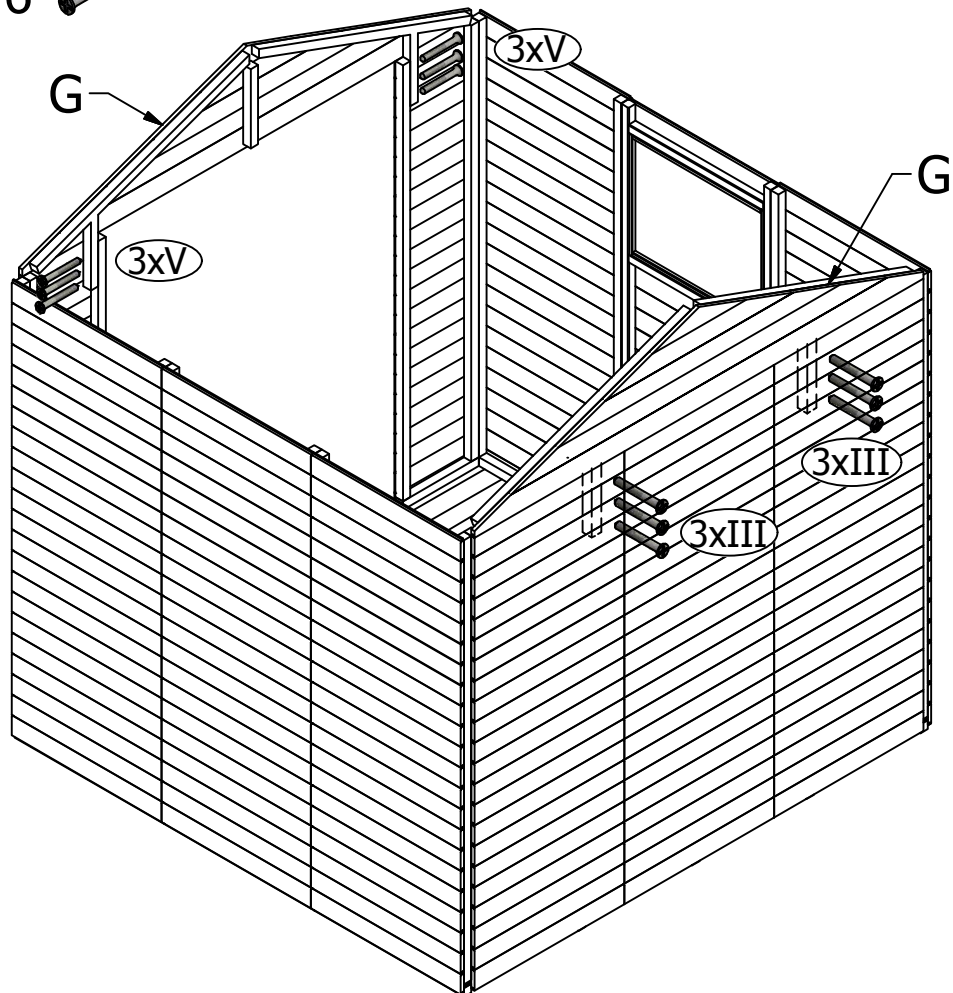

III - 4,0x35 #6

V - 4,0x55 #6

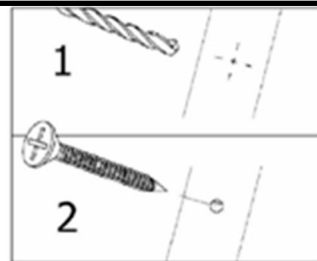
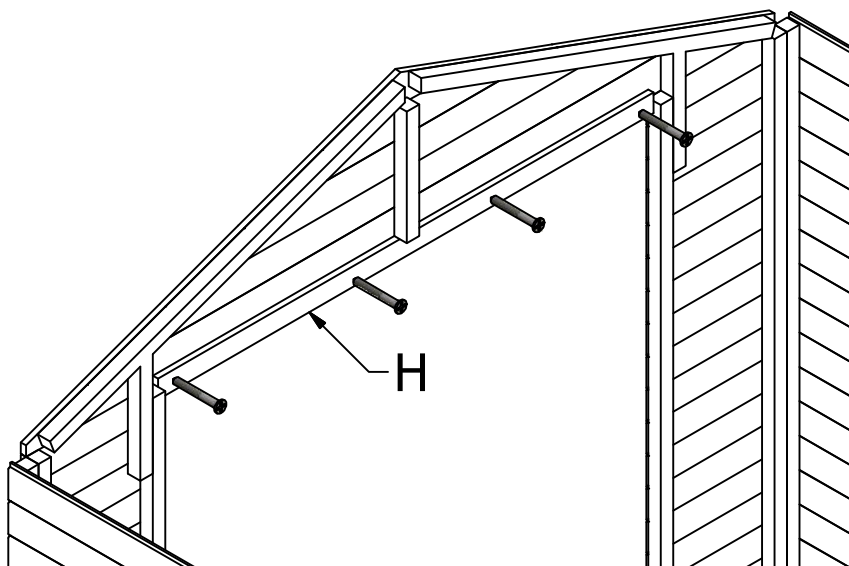

II - 4,0x25 #4 



V - 4,0x55 #4 

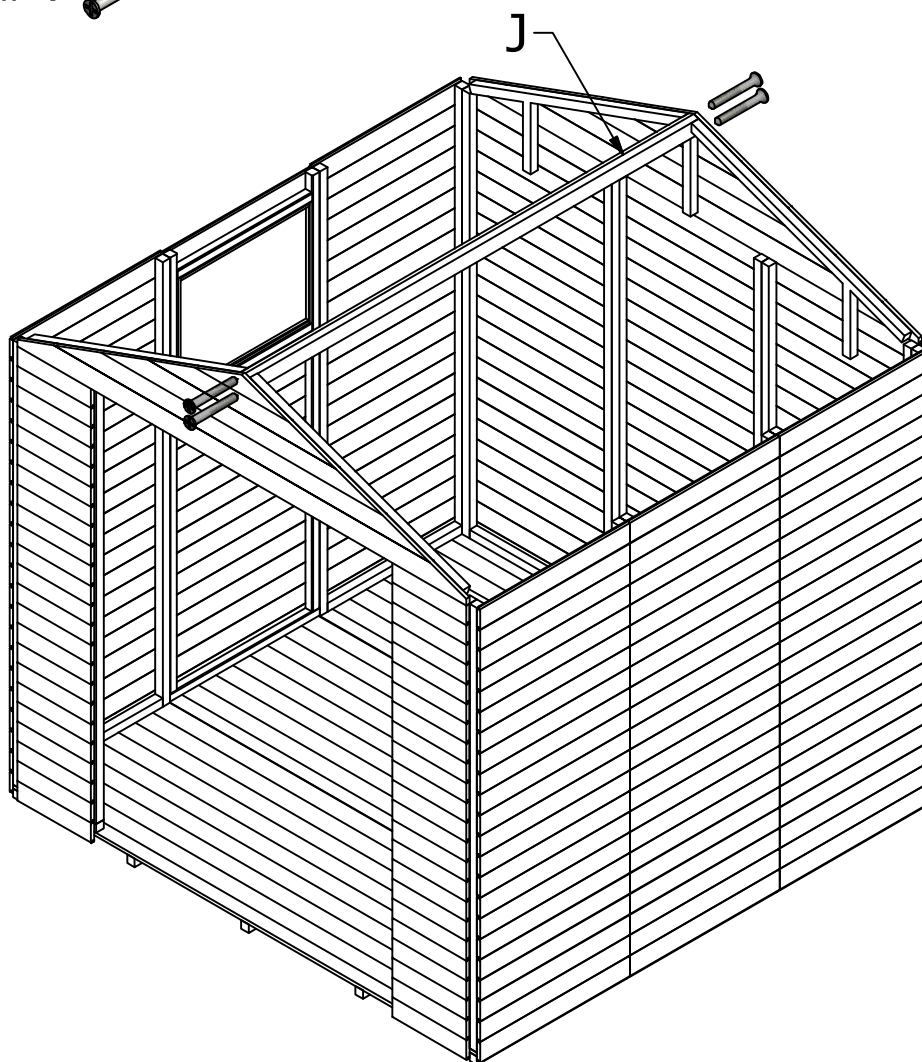

VI - 4,5x90 #8

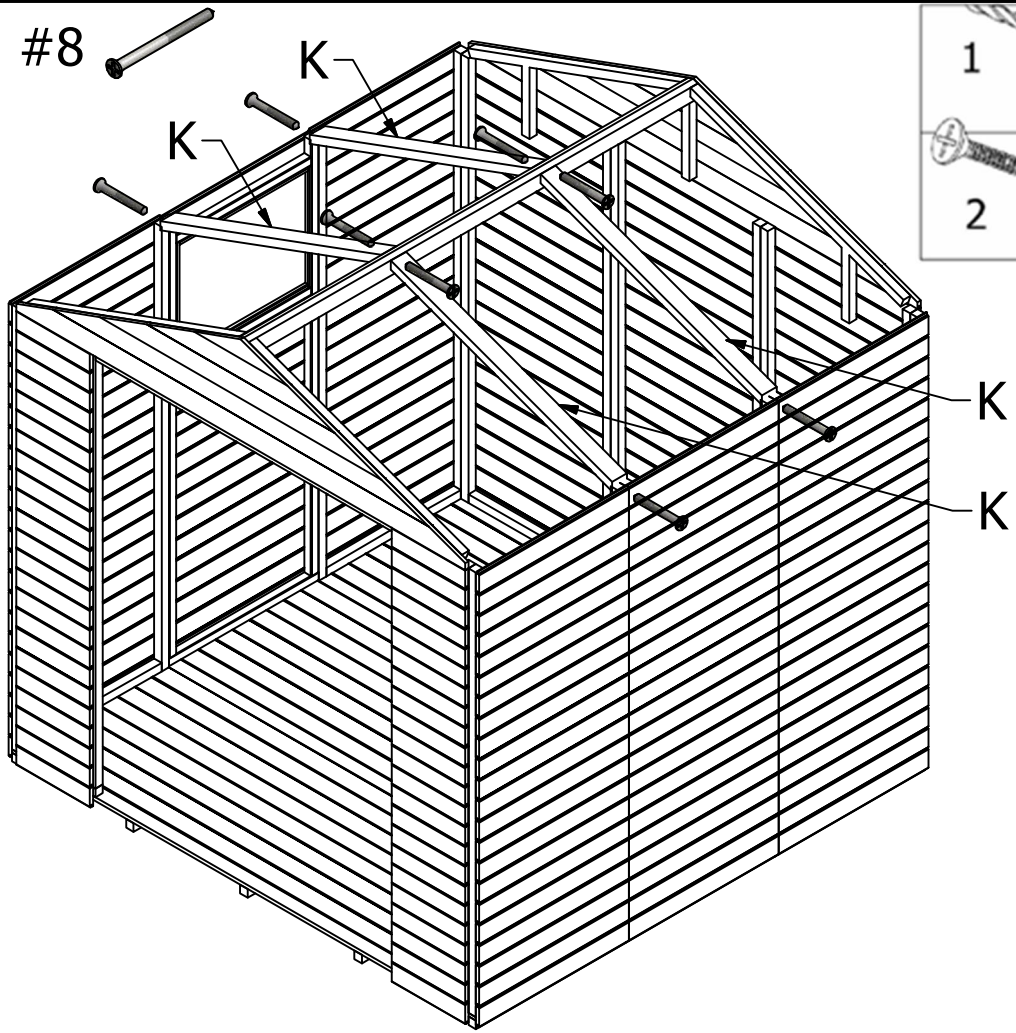

III - 4,0x35 #12

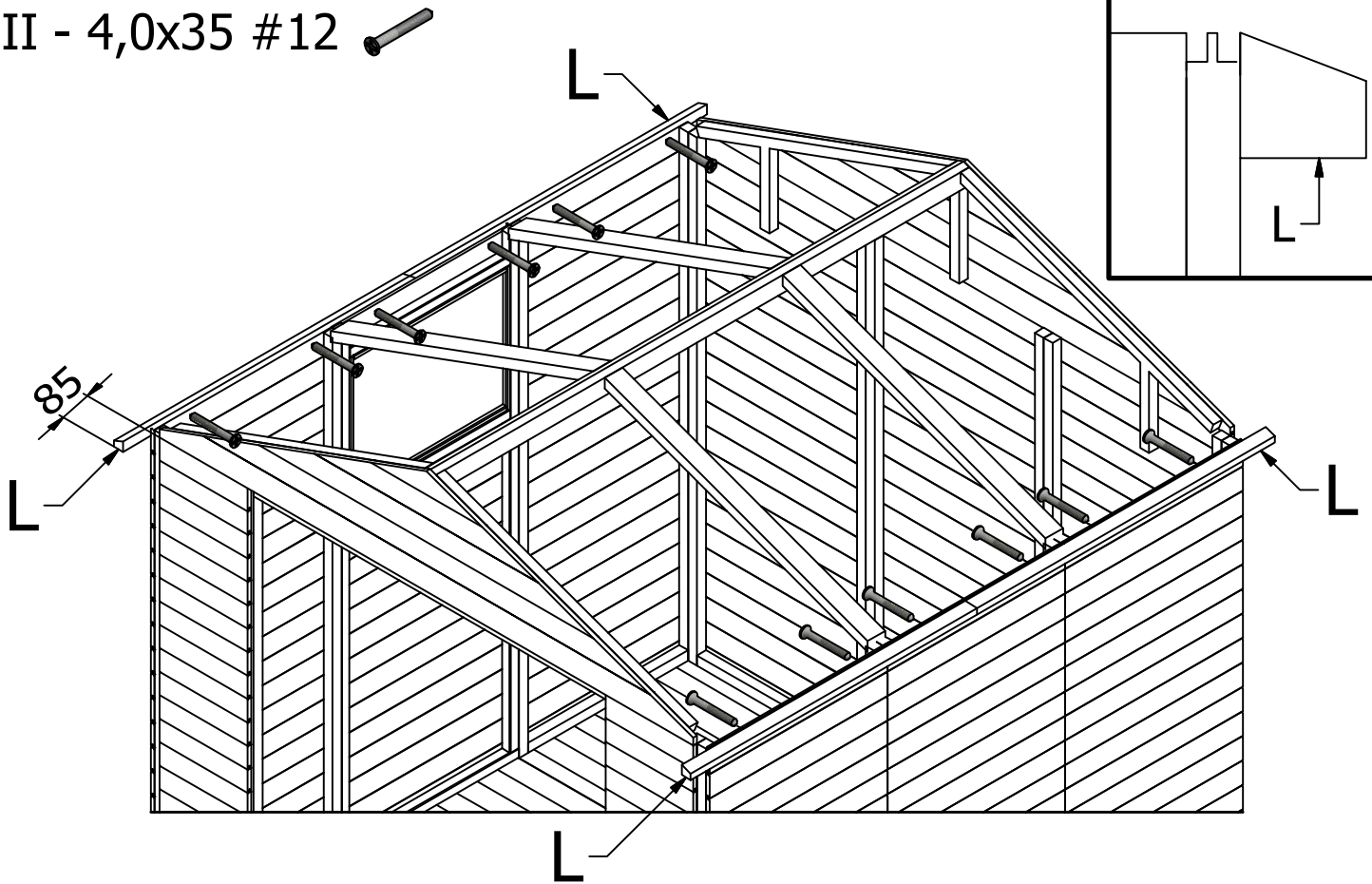



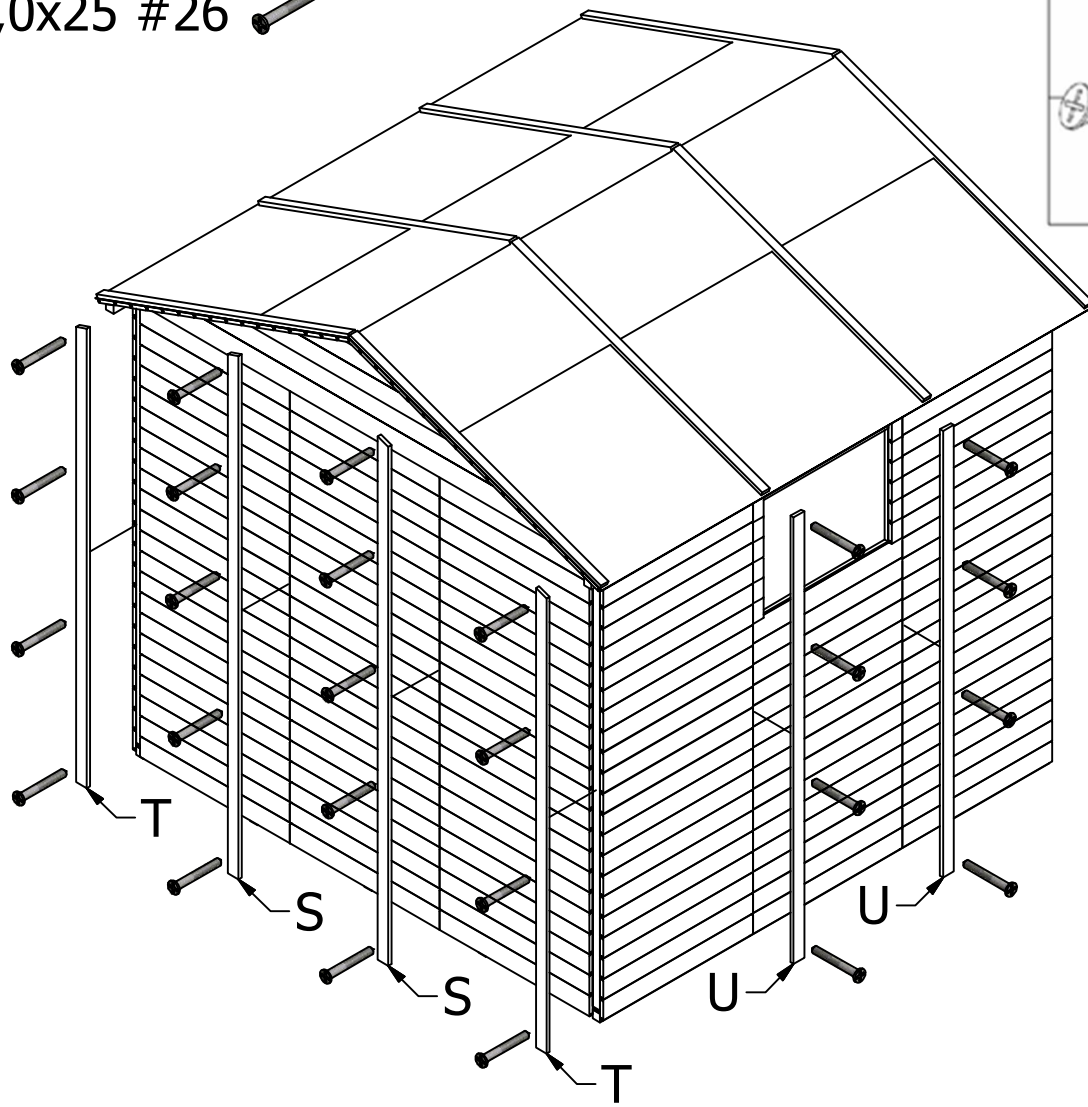
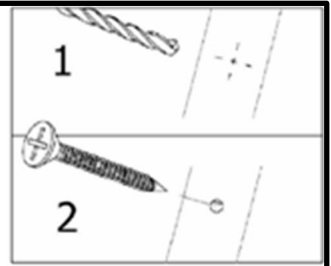

II - 4,0x25 #26 

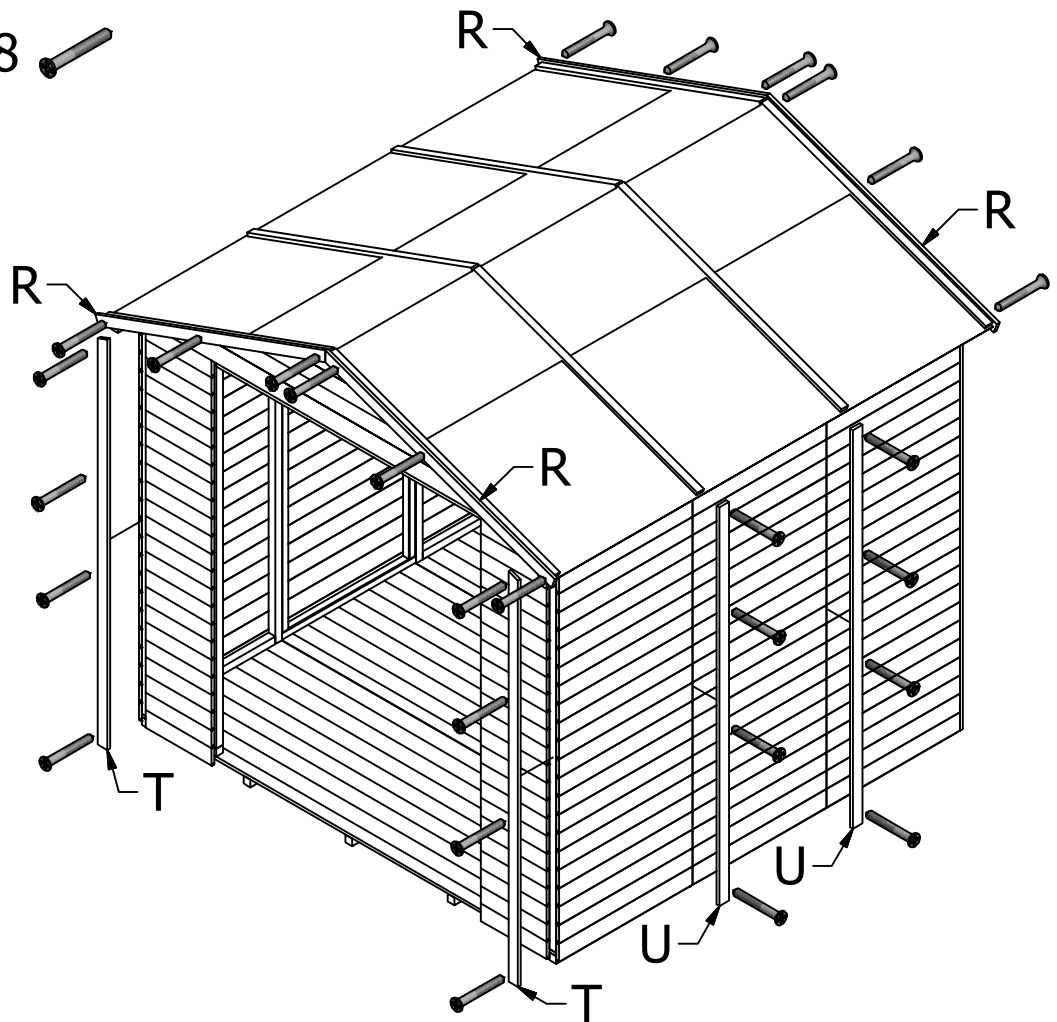

II - 4,0x25 #28 

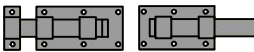

- I - 4,0x15 #6 
- II - 4,0x25 #8 
- IV - 4,0x45 #26 

- VII - 100x40 #2 
- VIII - 300x90 #4 

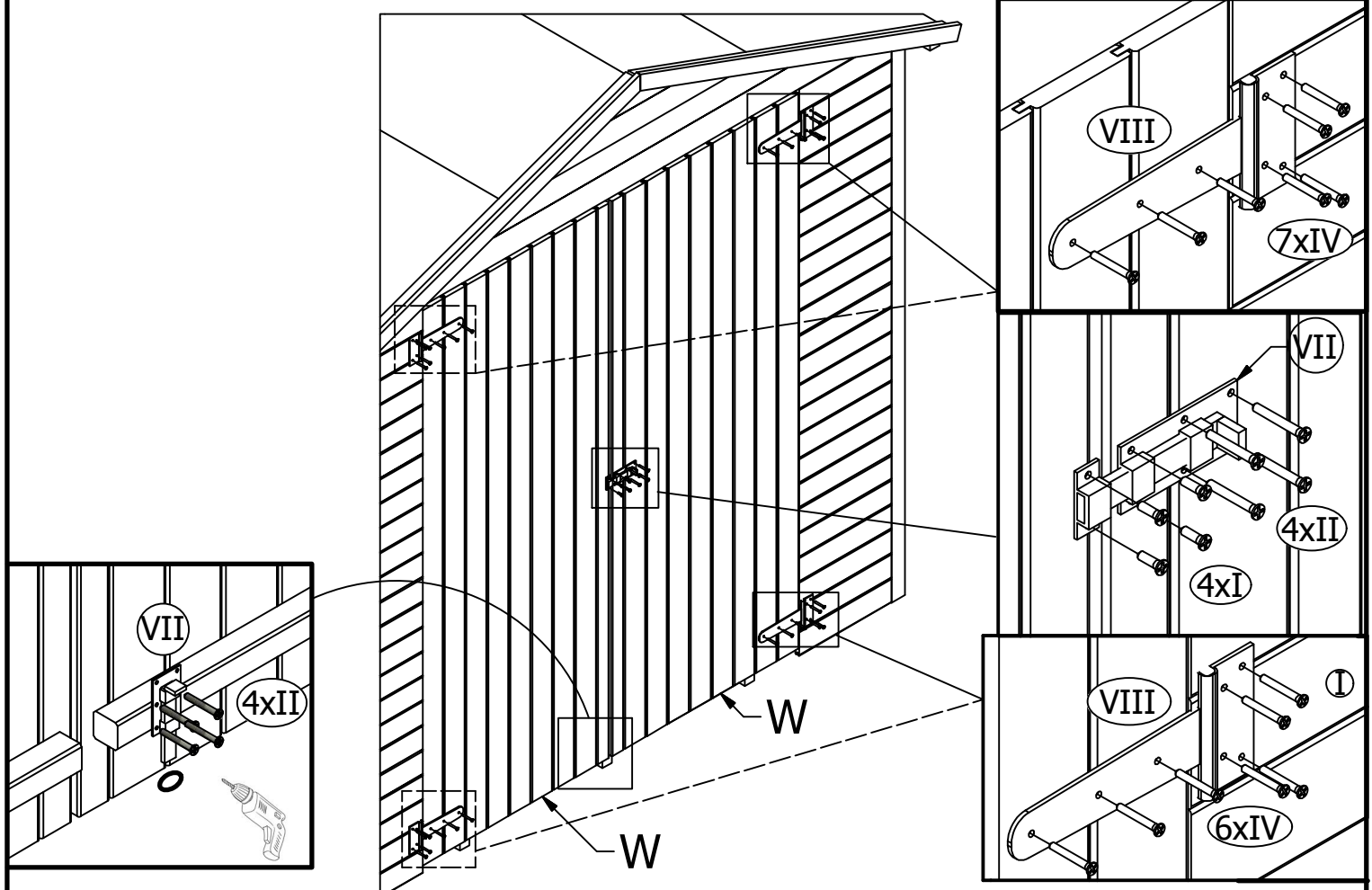
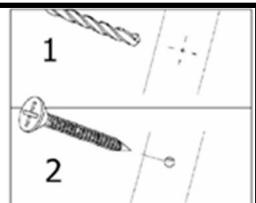

- II - 4,0x25 #6 

