

1.

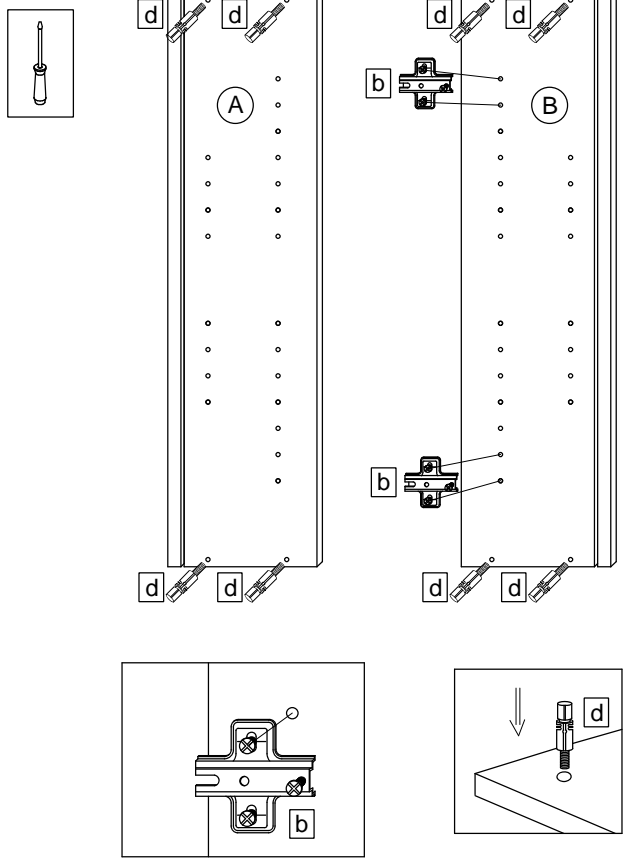

3.

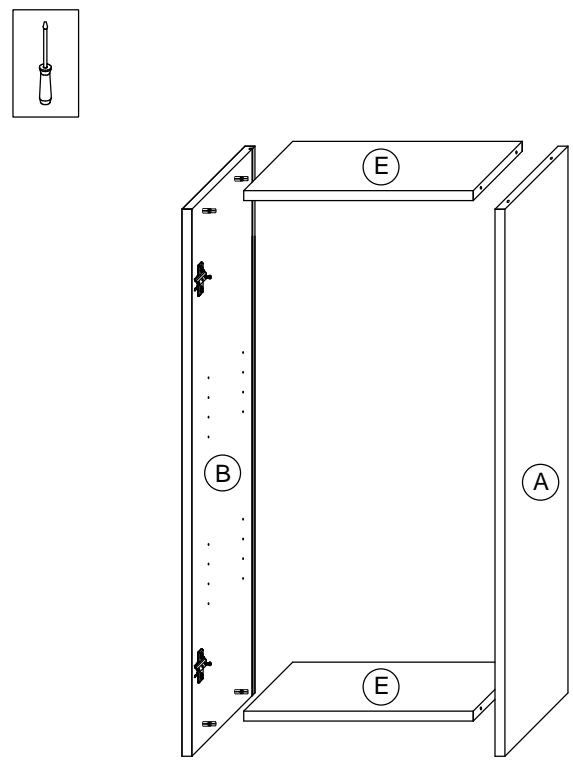

2.

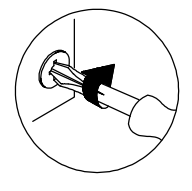
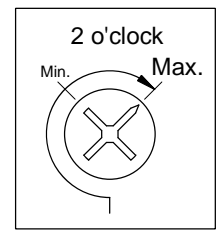
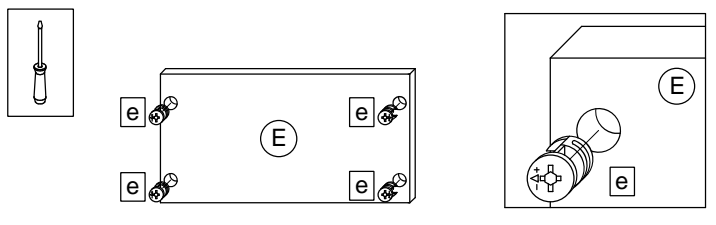

4.

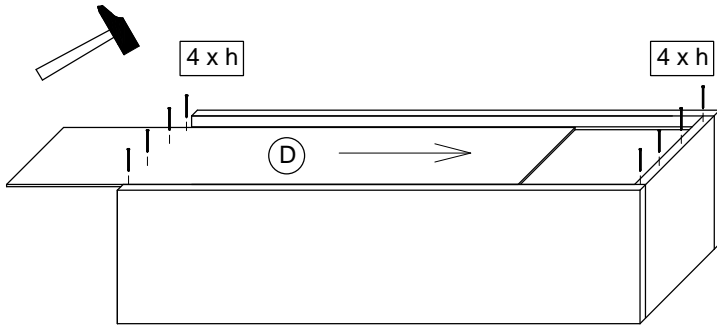
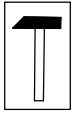

5.

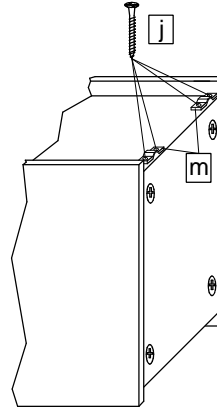
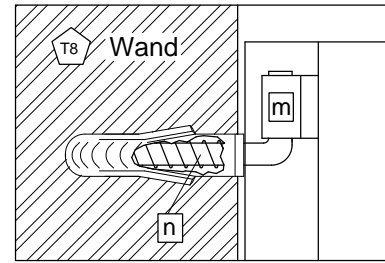
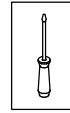

T9 Lassen Sie den Schrank nur durch fachkundige Personen mit für die Wand geeignetem Montagematerialien montieren.

6.

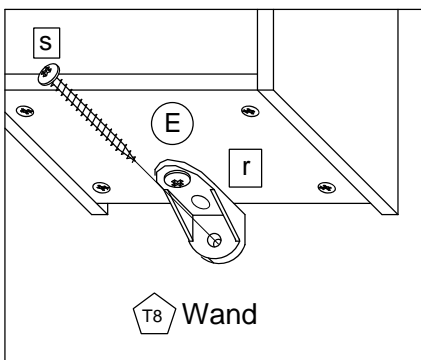
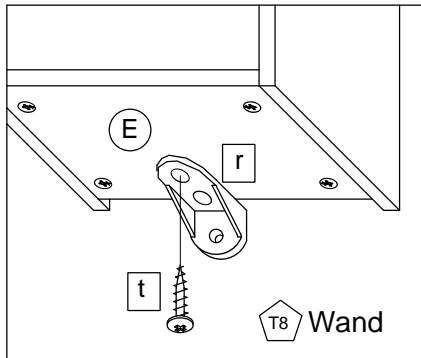
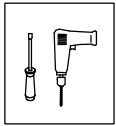

7.

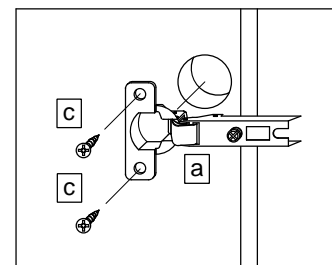
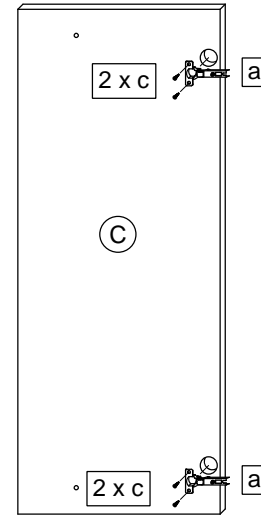
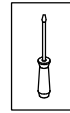

T5 Das Etikett, welches sich unten rechts befindet bitte ausschneiden und auf der Rückwand mit Klebeband (nicht beiliegend) befestigen.

PELIPAL GmbH
 Hans-Wilhelm-Peters-Straße 2

33189 Schlangen
 Germany

8.

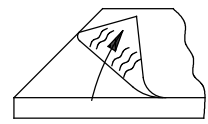
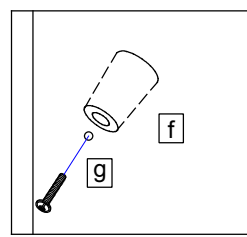
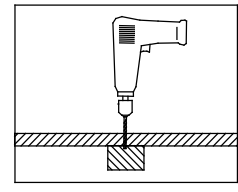
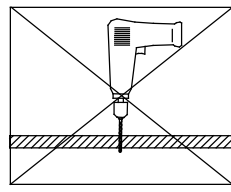
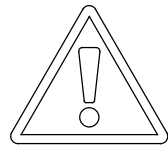
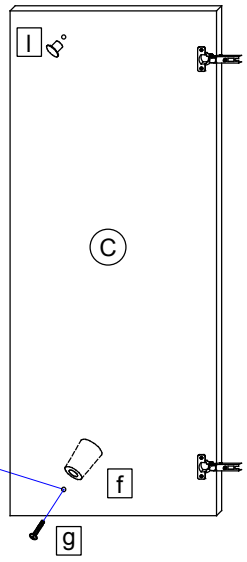
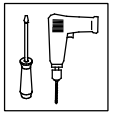

T10

Bei Hochglanz-Fronten bitte erst die Schutzfolie entfernen und dann den Griff montieren!

9.

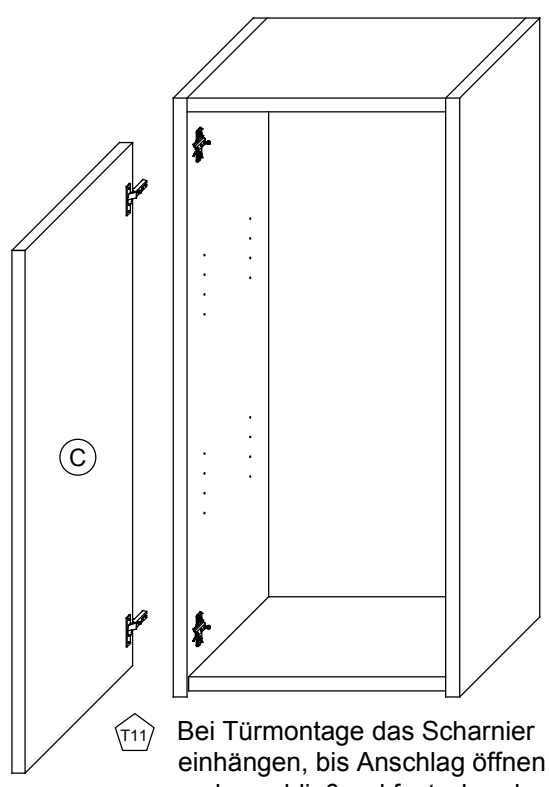
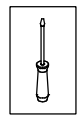

T11

Bei Türmontage das Scharnier einhängen, bis Anschlag öffnen und anschließend festschrauben.

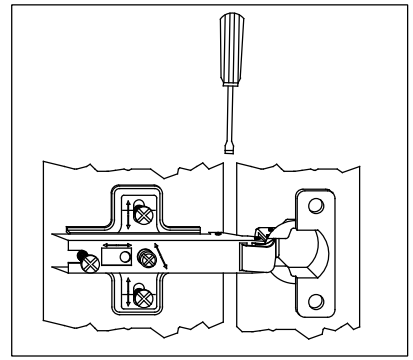
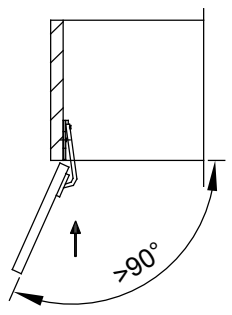

10.

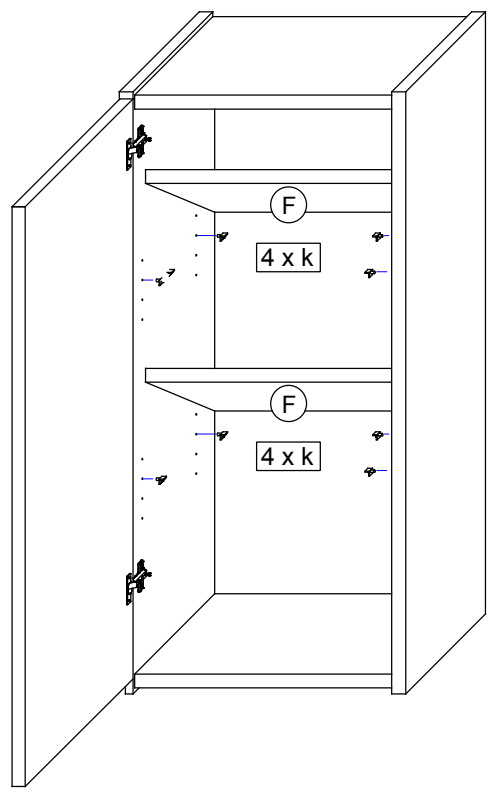

T12

Das Möbel bitte nur mit einem feuchten Tuch reinigen.