



T1

Bitte unbedingt ausfüllen!

Name _____

Strasse _____

Plz _____ Ort _____

Tel. _____

T2

Sehr geehrte Kunden,
wir freuen uns, dass Sie sich für ein Produkt aus dem Hause Pelipal entschieden haben. Sollte es trotz aller Bemühungen unsererseits, Ihnen ein qualitativ hochwertiges Möbelstück zu liefern, zu Fehlteilen kommen, schicken Sie bitte dieses ausgefüllte Blatt an

Fax.: **+49 3443/434354**

E-Mail: **ersatzteile@pelipal.de**

Bitte beachten Sie, dass Bauteile über 800mm Länge und 350mm Breite direkt bei Ihrem Möbelhändler zu beanstanden sind. Zur Reklamationsbearbeitung ist es unbedingt erforderlich **die Artikelnummer des Schrankes**, welche auf dem Etikett ersichtlich ist und den Markt, wo das Möbel erworben wurde anzugeben. Außerdem tragen Sie unten bitte die benötigte Stückzahl ein. Viel Spaß mit Ihrem neuen Badmöbel! Ihr Pelipal Team

_____ - _____

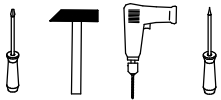









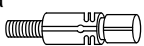

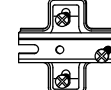
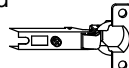

T3

Für den Zusammenbau sind 2 Personen erforderlich.

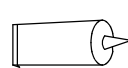
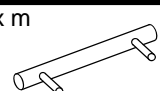
T4

Montage-Richtzeit 3 Stunden

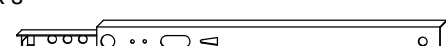
16 x a  DUEB-SMD-000005	Stück	16 x b  EXZENTER-000015	Stück	4 x c  ZPL-016X000	Stück	4 x d  TBD-26-115X00	Stück	2 x e  SCH-KA-M04X009	Stück
20 x f  NAGEL-025X001	Stück	8 x g  SCH-SPA-035X015	Stück	4 x h  SCH-KA-063X011	Stück	12 x k  TRAE-001-000020	Stück	1 x l  LEIM-00015G	Stück
3 x m  Griff	Stück	6 x n  Griffschraube	Stück	4 x p  ADK-__-005X008	Stück	4 x r  DUEB-HLZ-008X030	Stück		Stück
2 x s  KA-246-1700			Stück		Stück		Stück		Stück

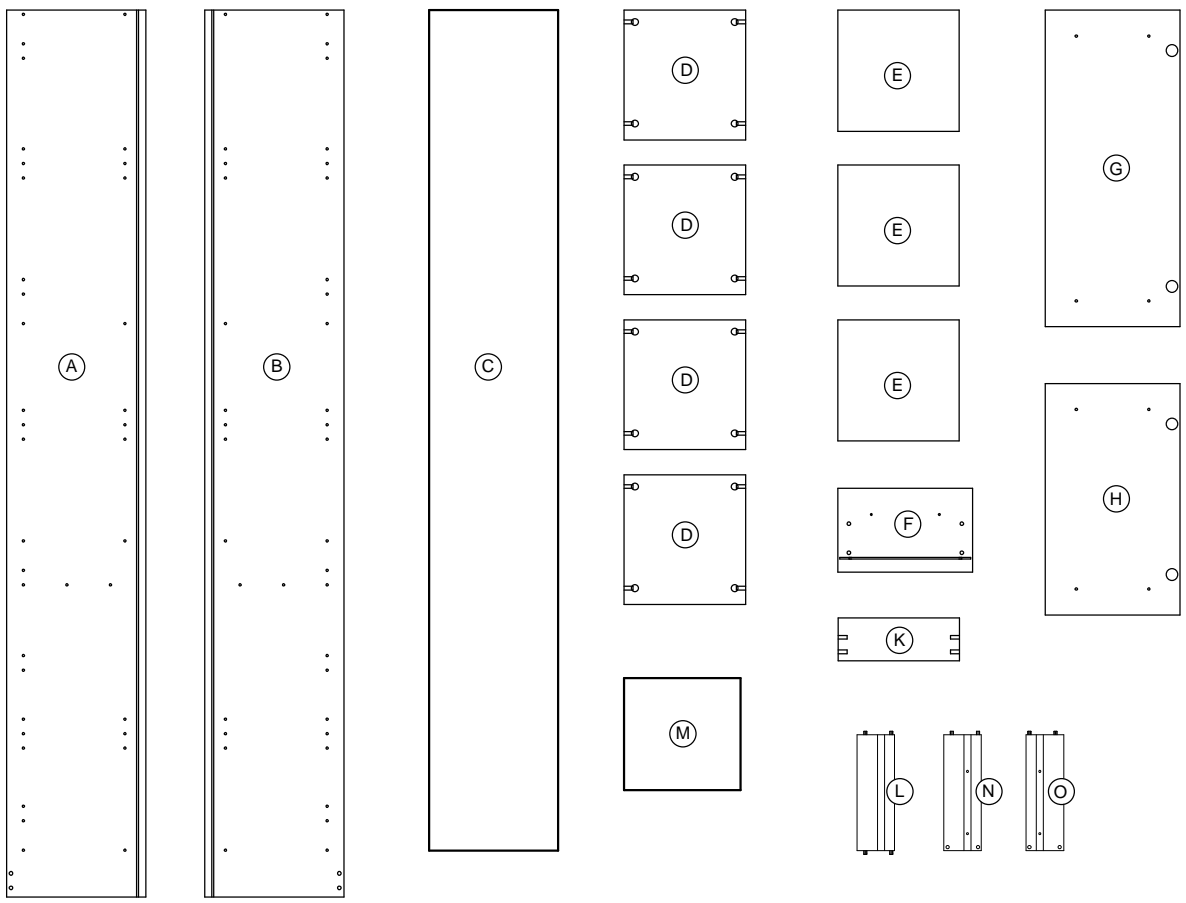

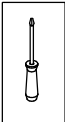
1. 

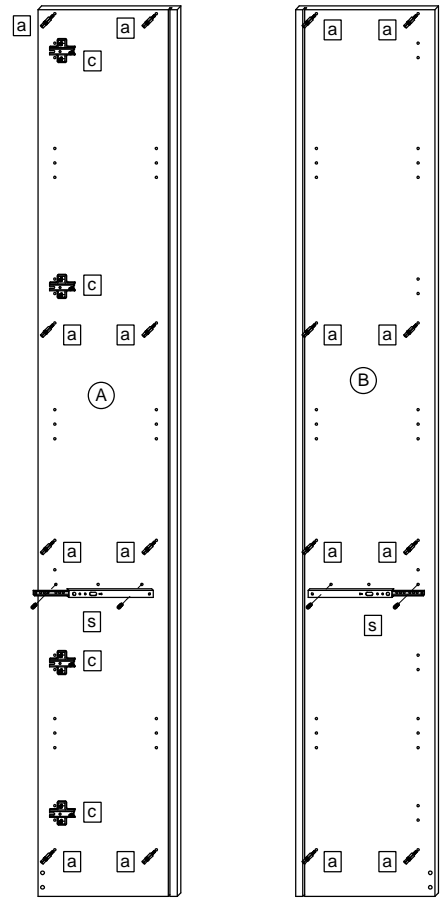
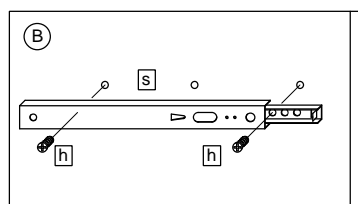
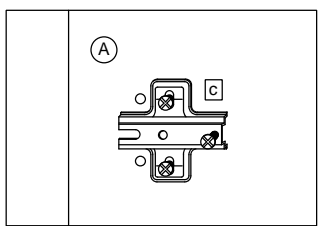

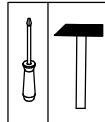
2. 

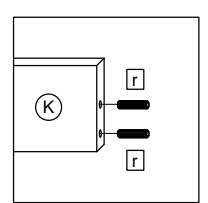
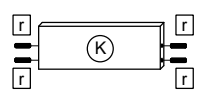
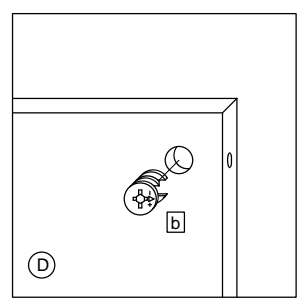
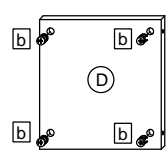

3.

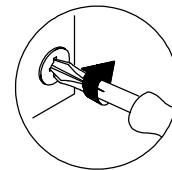
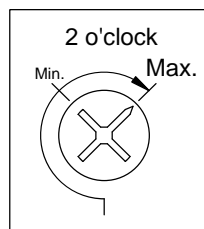
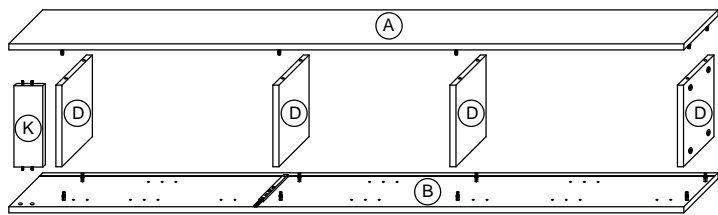
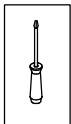

4.

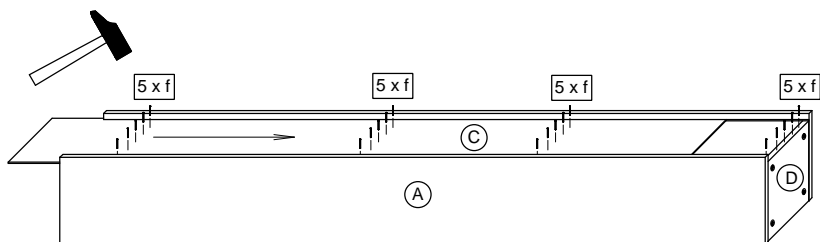
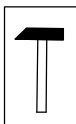

5.

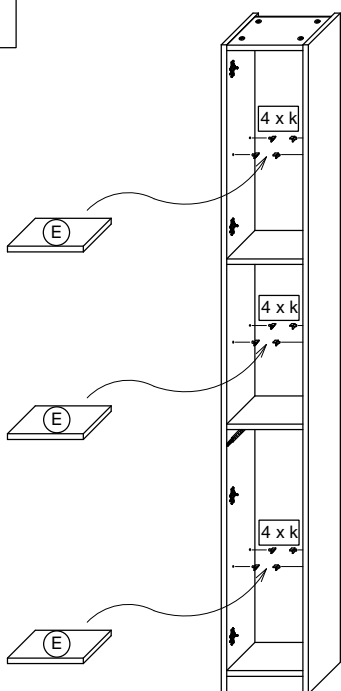
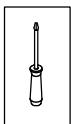

6.

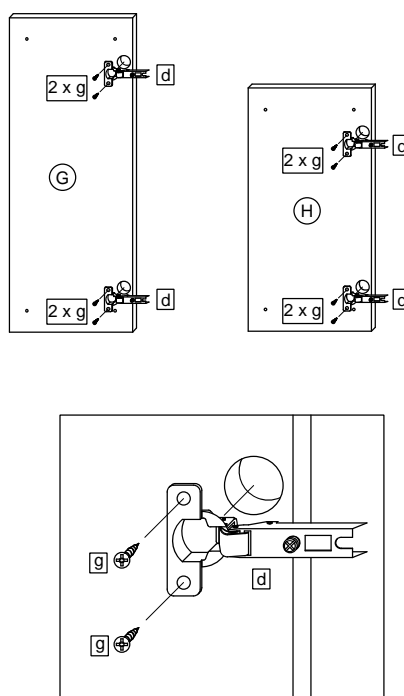
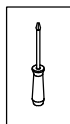

T5

Das Etikett, welches sich unten rechts befindet bitte ausschneiden und auf der Rückwand mit Klebeband (nicht beiliegend) befestigen.

PELIPAL GmbH
Hans-Wilhelm-Peters-Straße 2

33189 Schlangen
Germany

7.

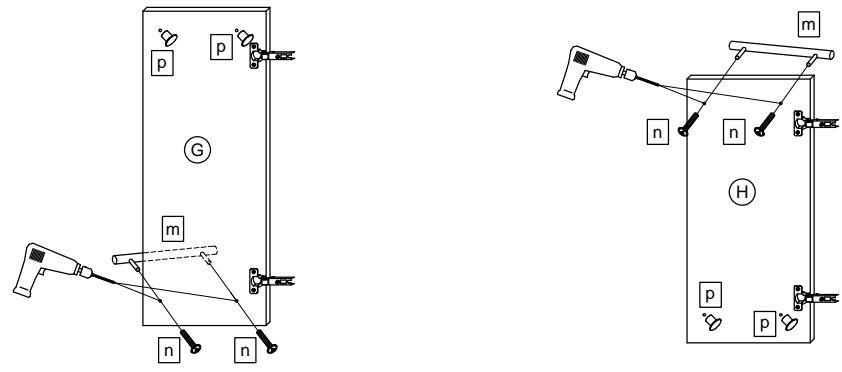
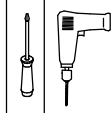

7.1

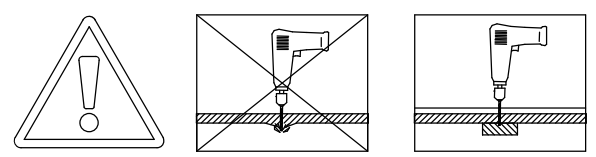

7.2

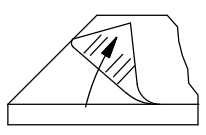

Bei Hochglanz-Fronten bitte erst die Schutzfolie entfernen und dann den Griff montieren!

7.3

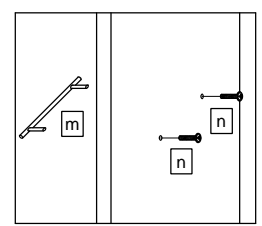

8.

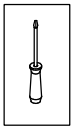

T11 Bei Türmontage das Scharnier einhängen, bis Anschlag öffnen und anschließend festschrauben.

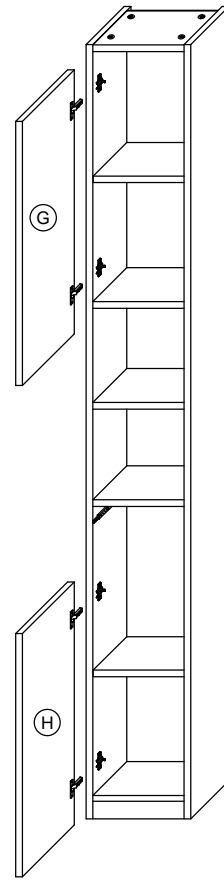
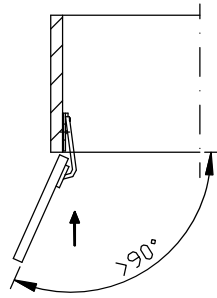
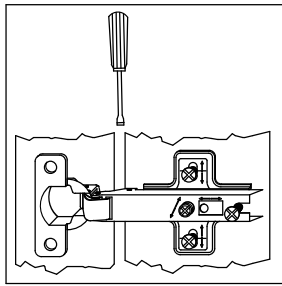

9.

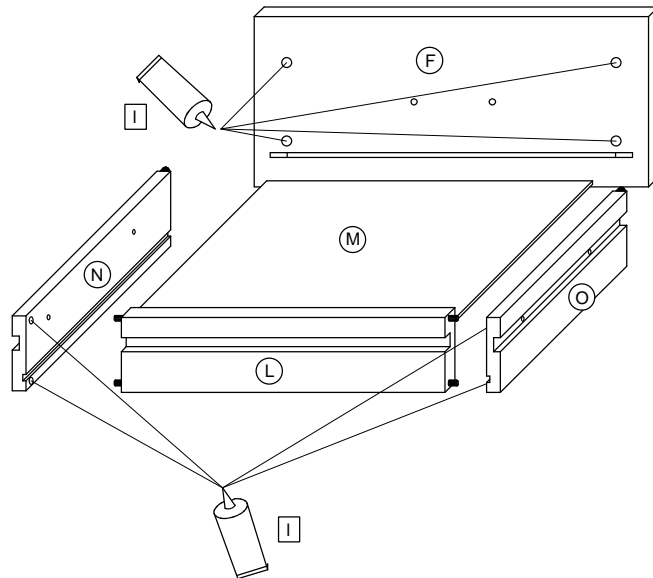

10.

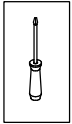

10.1

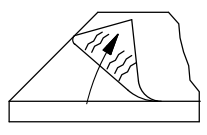

Bei Hochglanz-Fronten bitte erst die Schutzfolie entfernen und dann den Griff montieren!

10.2

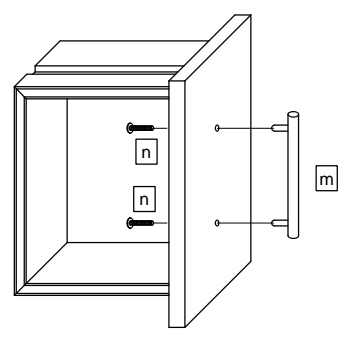

11.

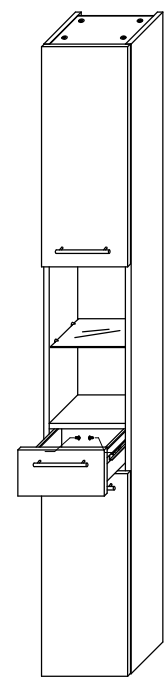
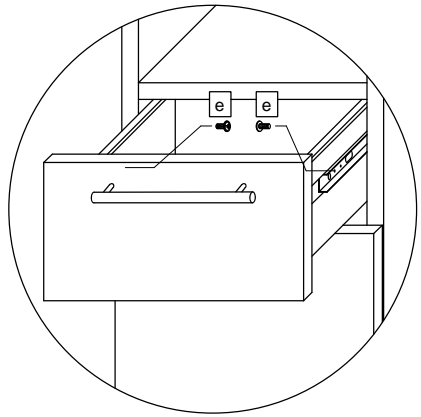
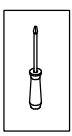

Das Möbel bitte nur mit einem feuchten Tuch reinigen.