

UTILITY CABINET

~ 65 x 37 x 86.5 cm (H)

~ 25.6 x 14.6 x 34 in (H)



STARPLAST



A x2
1101946

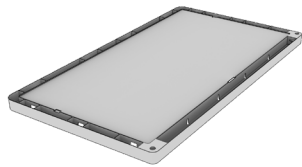

B x1
5101946

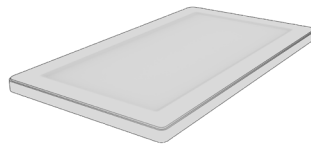

C x1
4101946

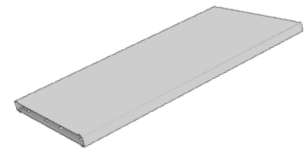

D x1
3101946

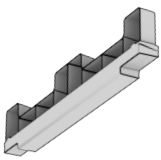

E x2
8101946

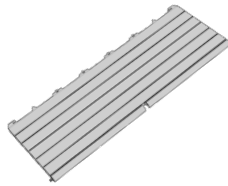

F x2
2101946



G x2
6101946

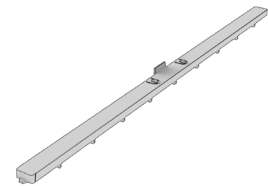

H x2
7101946

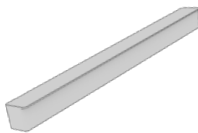

I x2
10101946

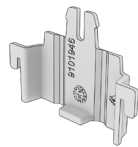

J x1(+1)
9101946

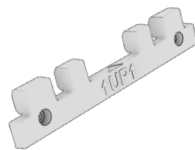

K x2
16101946

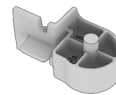

L x2
15101946



M x8(+1)
VPT079723-SCREW

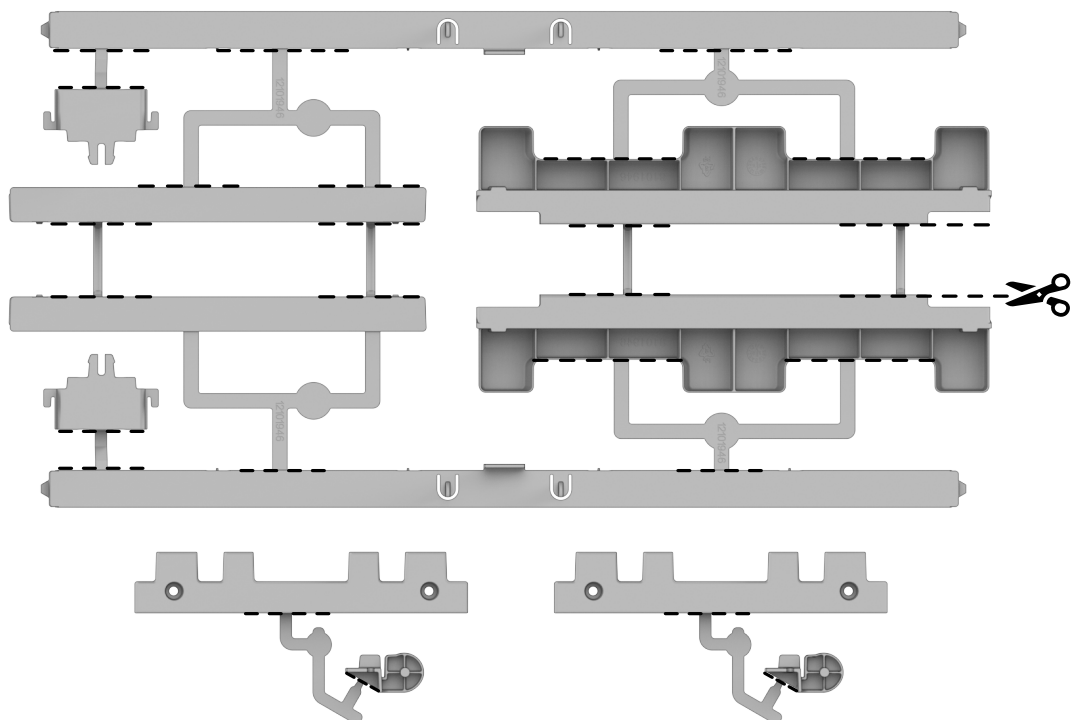

1

B

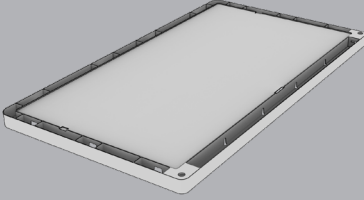

H x1

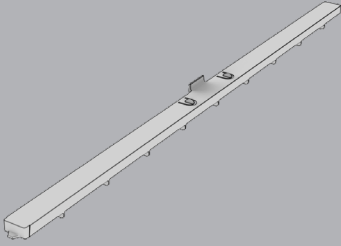

1.1

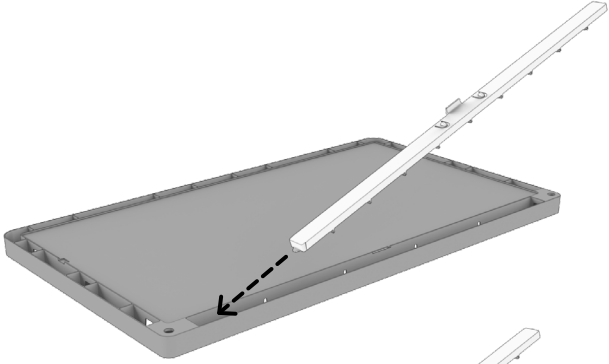

1.2

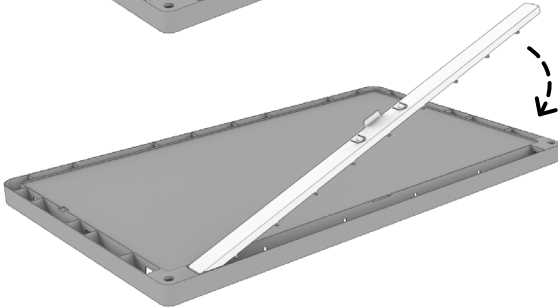

1.3

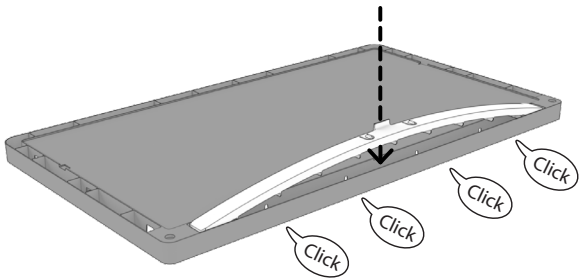

2

A x2

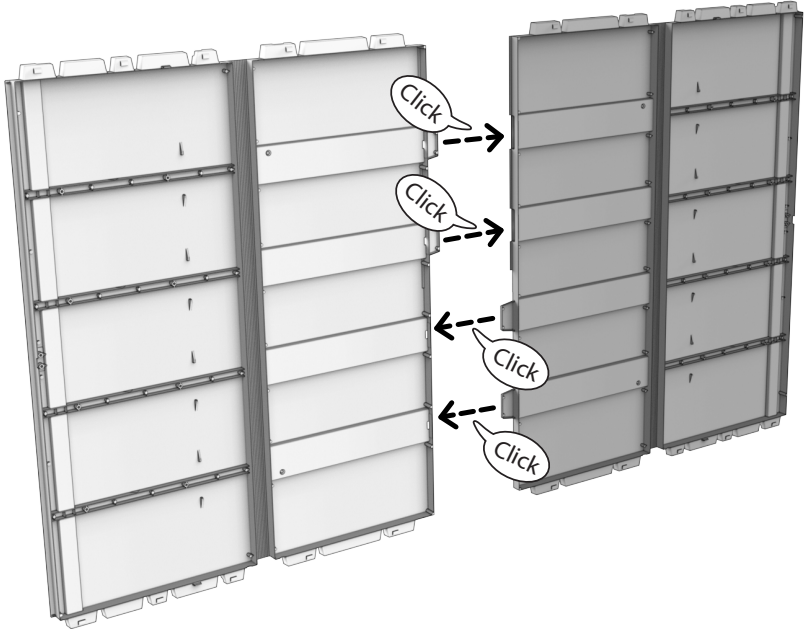

3

K x2

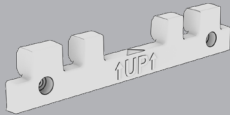

M x4

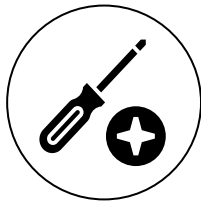

x2

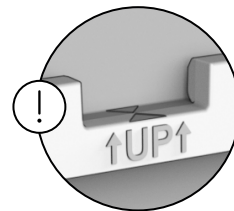
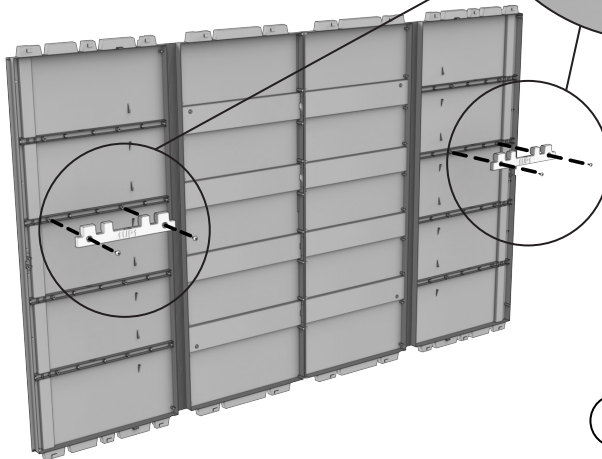
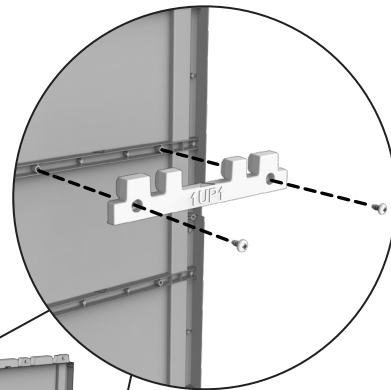

4

L x2

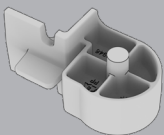

M x4

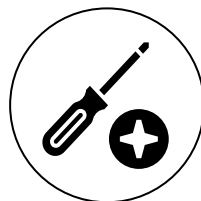

x2

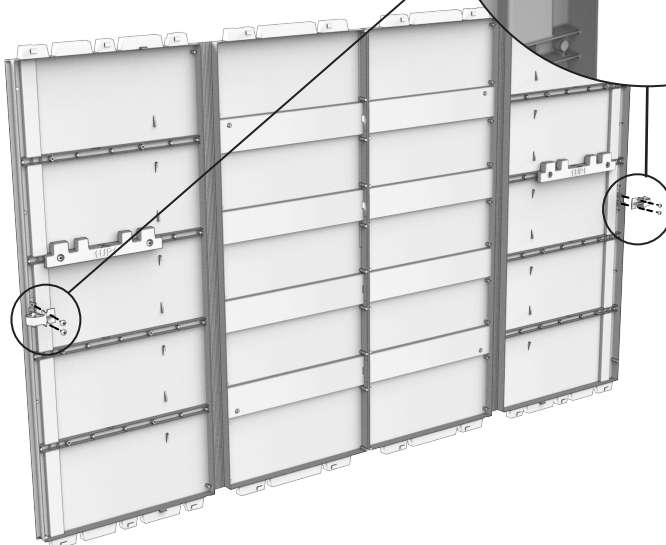
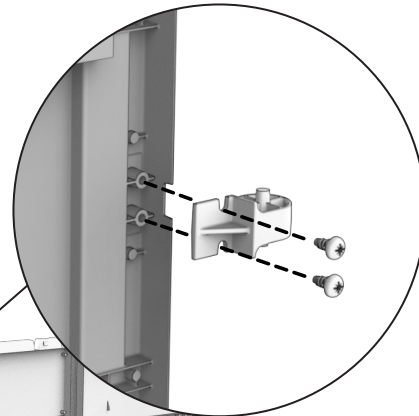

5

5.1

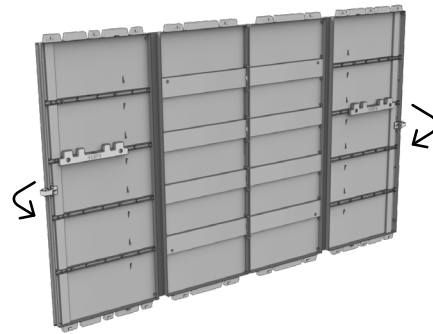

5.2

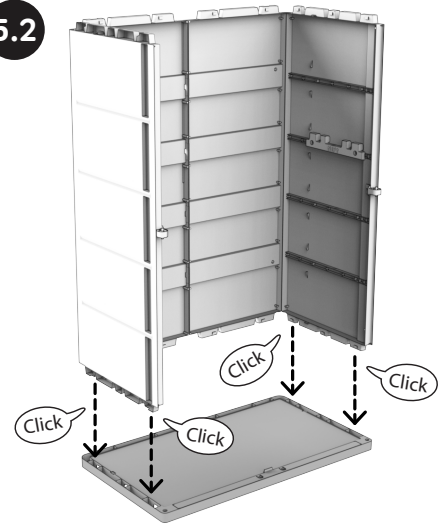

6

J x1

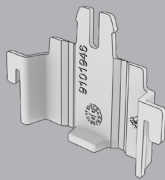

6.1

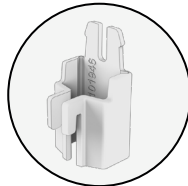
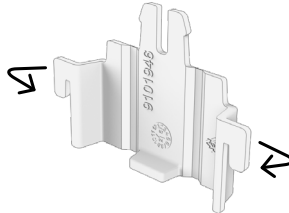

6.2

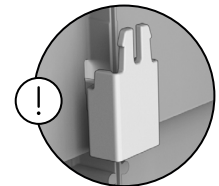
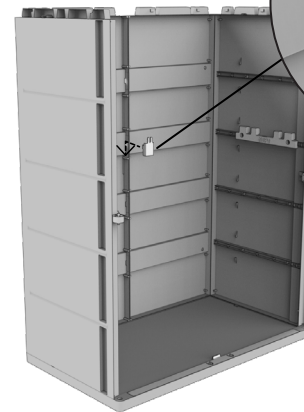

7

D



E x2

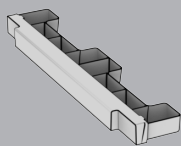

7.1

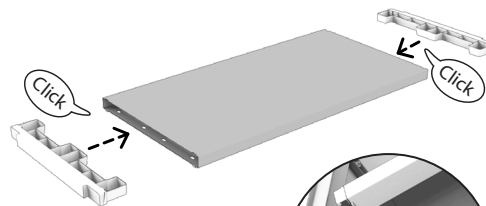

7.2

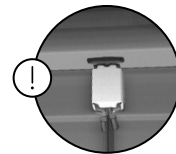
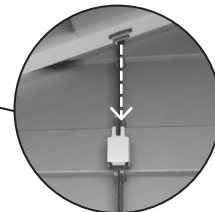
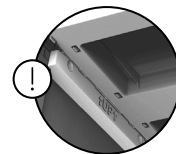
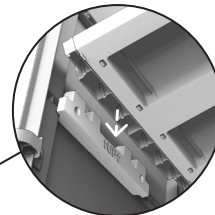
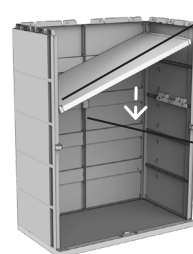

8

F x2

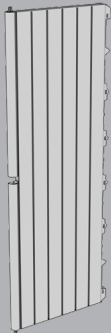

G x2

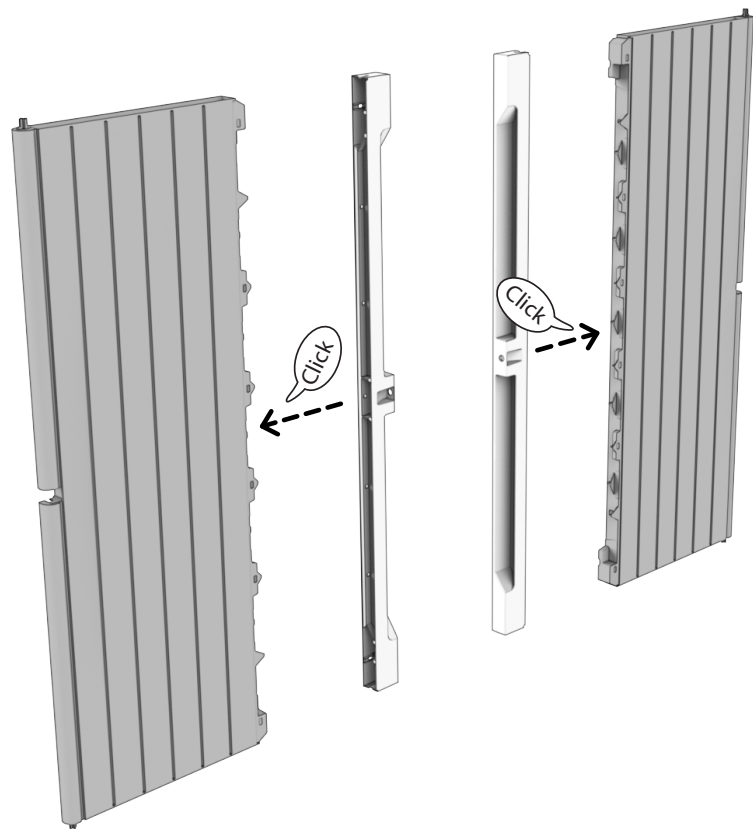
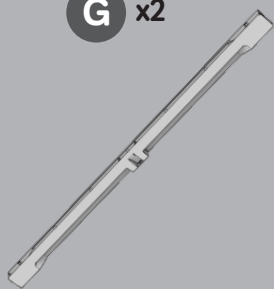

9

9.1



x2



9.2

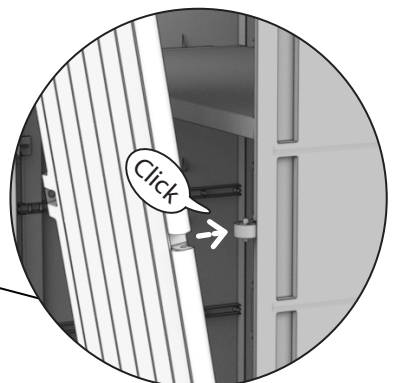
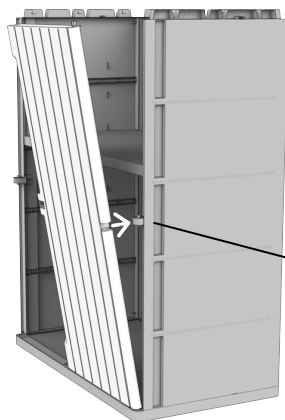

10

C

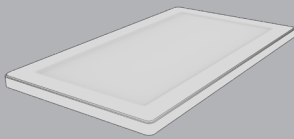

H x1

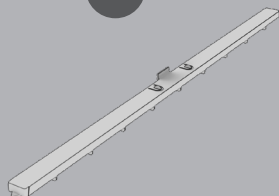

10.1

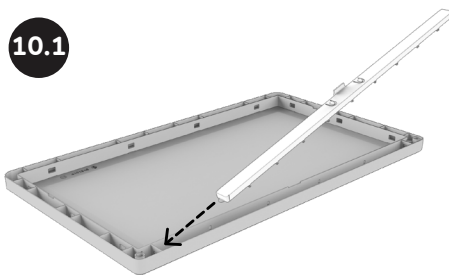

10.2

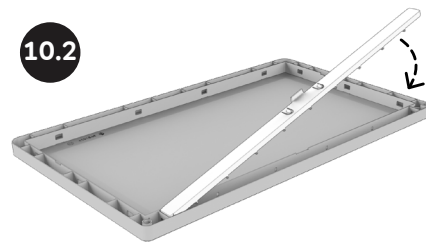

10.3

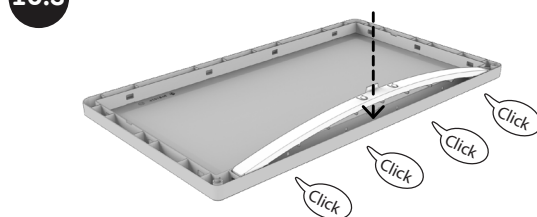

11

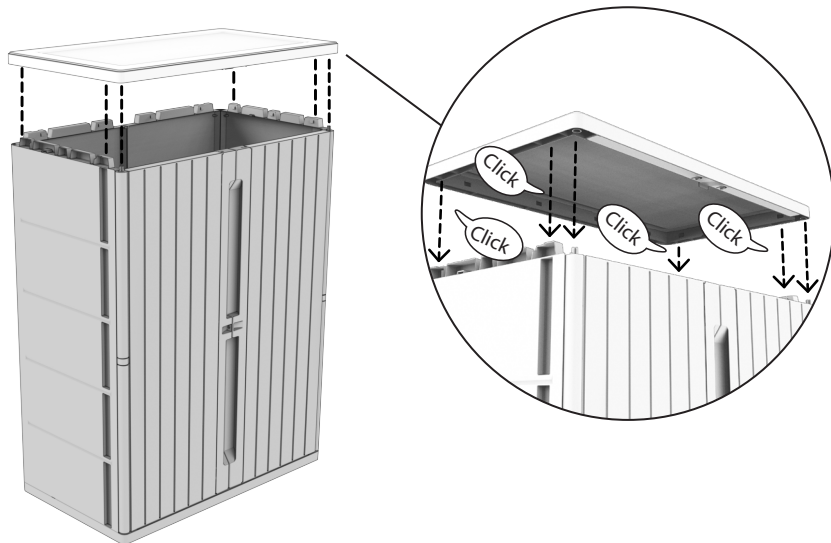

12

I x2

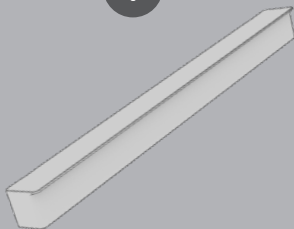

x2

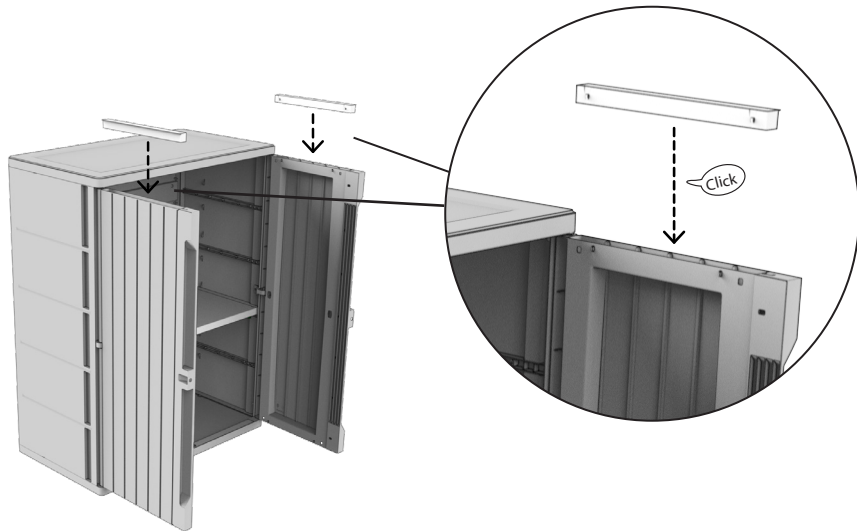

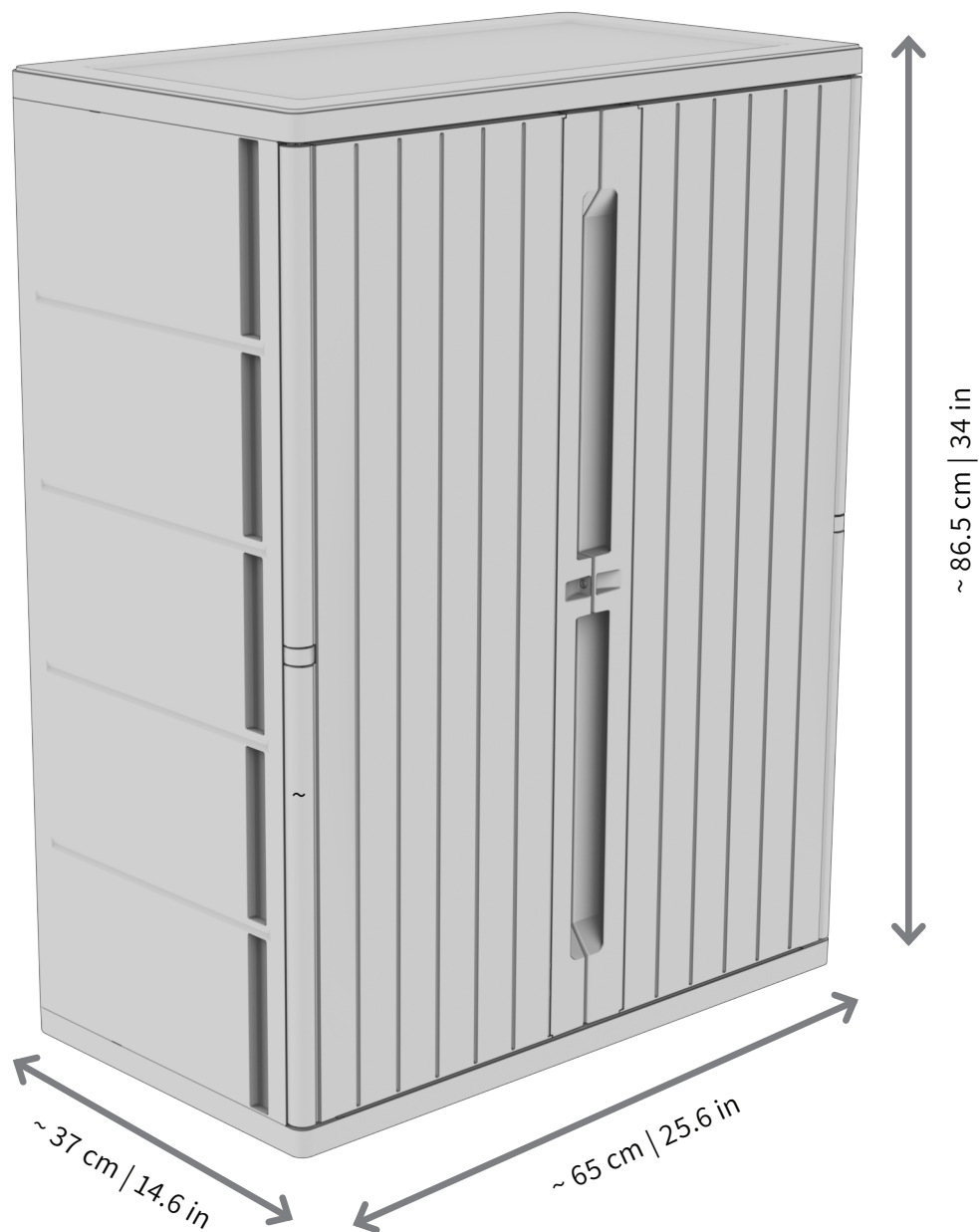

Volume: 173 liter | 46 gal

G25525, SKU I01946

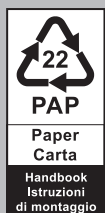

Raccolta differenziata. Verifica le disposizioni del tuo Comune.



FR
DONNEZ
OU
RECYCLEZ



ASSOCIATION



MAGASIN



DÉCHÈTERIE

Adresses sur quefairedemesdechets.fr



FR
ÉLÉMENTS D'EMBALLAGE
À SÉPARER ET À DÉPOSER
DANS LE BAC DE TRI



BAC DE TRI



FR



STARPLAST

Starplast Europe srl, Chaussée de la Hulpe 1, 1180 Brussels, Belgium
Manufacturer: Starplast Industries (1967) Ltd.
<https://www.starplast.com/pages/contact-us>