

KEVO KLS 4-TRG

58/821../3



Wyprodukowano dla / made for / produziert für
BEGA GRUPPE
producent: **MEBLE OKMED POLAND**



SERIA: .../...

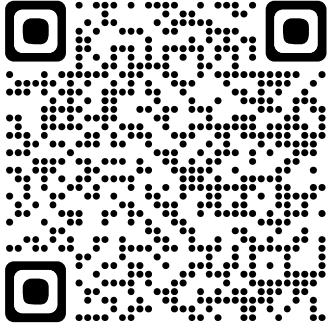
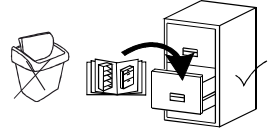

KEVO KLS
4-TRG
SERIA: ../..



1806

530

2250

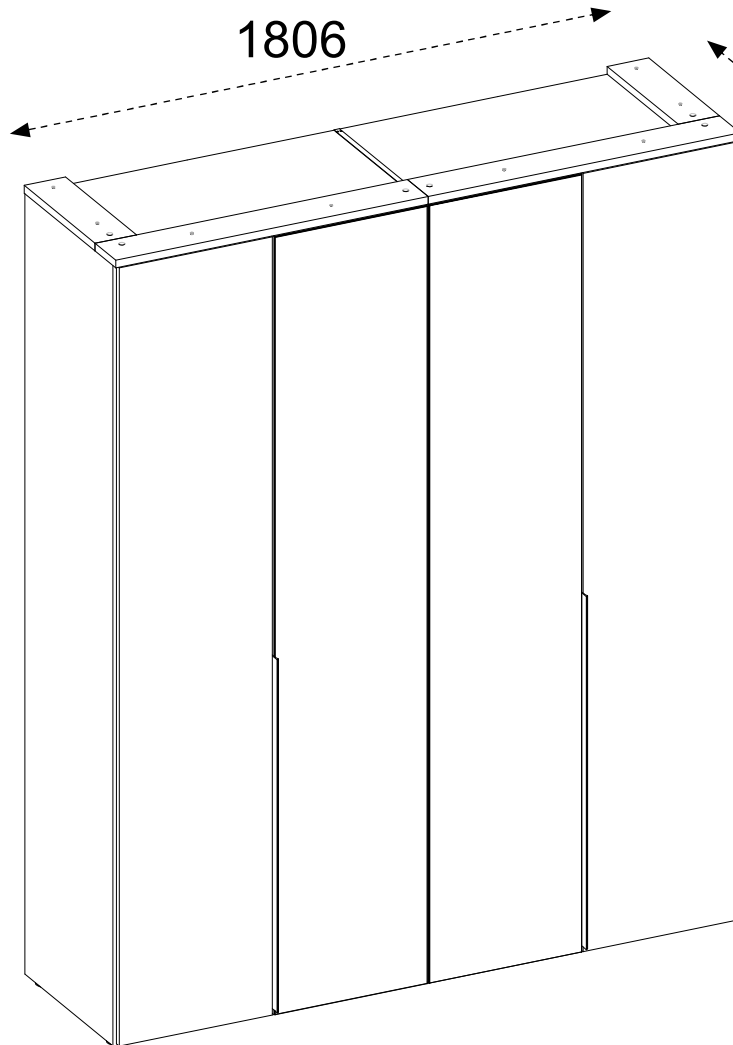

FR

Donnez ou recyclez vos meubles.

ou

Magasin

ou

Association

<https://quefairede mesdechets.fr>

Déchèterie

LE TRI FACILE

BAC DE TRI

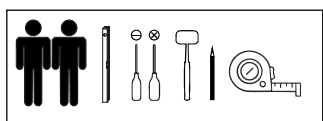

Ø10

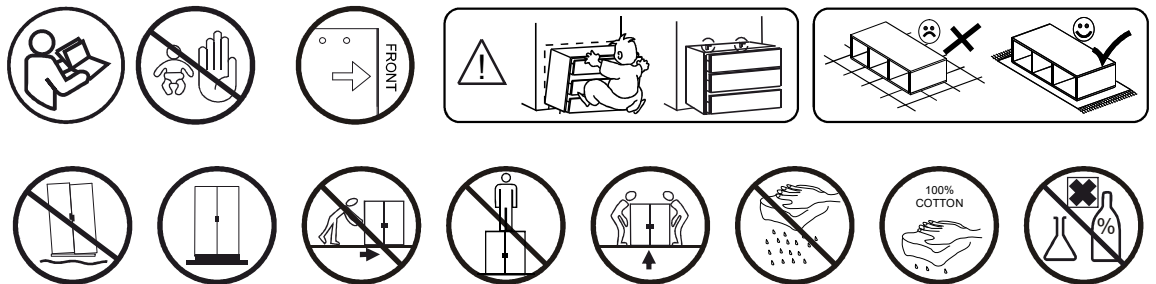

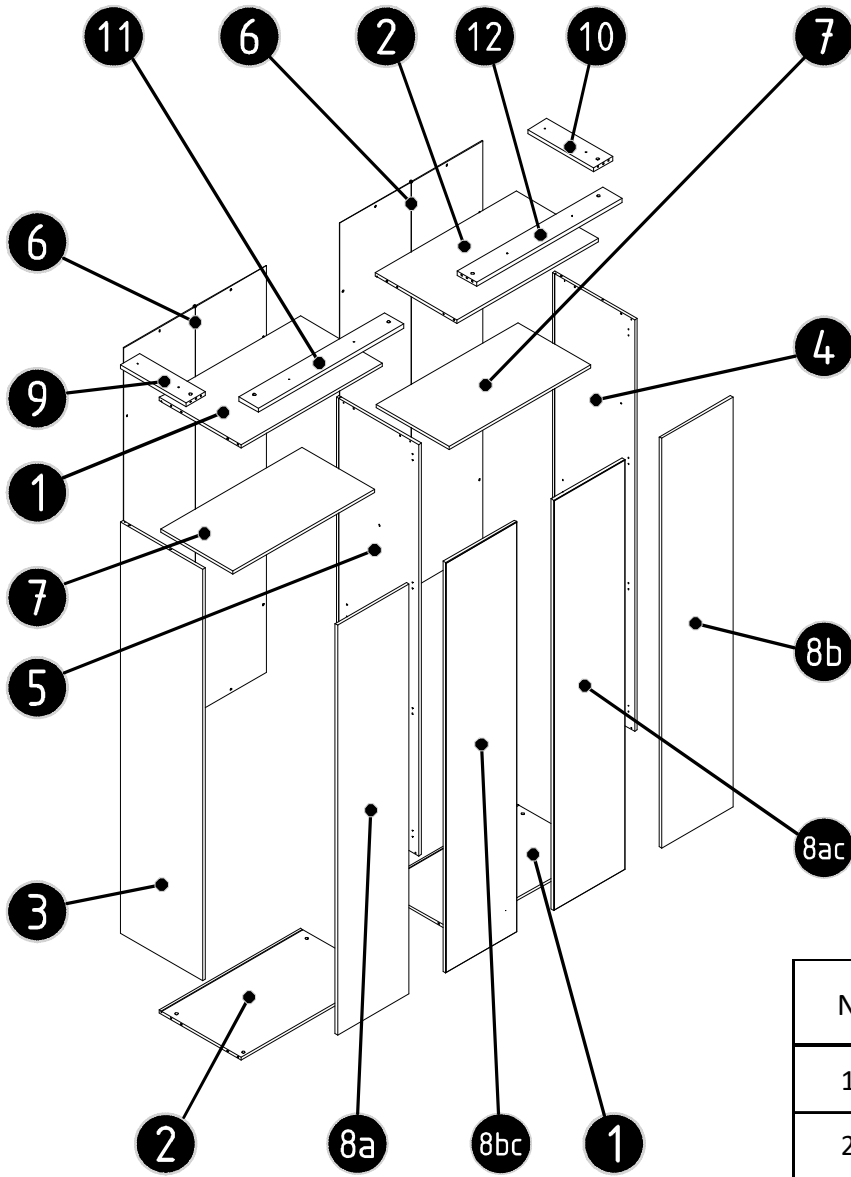

N	L [mm]	W [mm]	T [mm]	Q	COLLI
1	878	509	16	2	COLLI_1/5
2	878	509	16	2	COLLI_1/5
9	410	120	22	1	COLLI_1/5
10	410	120	22	1	COLLI_1/5
11	903	120	22	1	COLLI_1/5
12	903	120	22	1	COLLI_1/5
7	878	450	16	2	COLLI_1/6
3	2213	510	16	1	COLLI_2/5
4	2213	510	16	1	COLLI_2/5
6	2188	443	3	4	COLLI_2/5
5	2213	510	16	1	COLLI_3/5
8a	2205	443	16	1	COLLI_5/6
8ac	2205	443	16	1	COLLI_5/6
8b	2205	443	16	1	COLLI_6/6
8bc	2205	443	16	1	COLLI_6/6

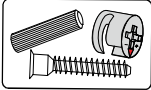

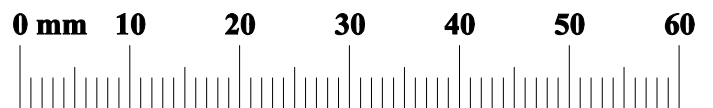
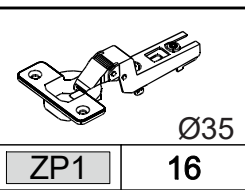
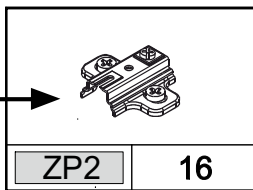
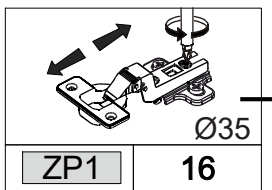
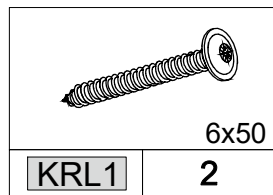
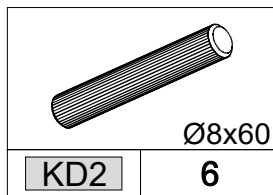
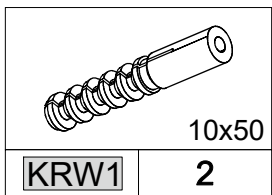
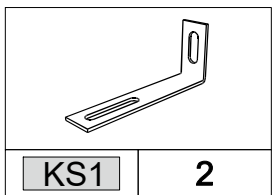
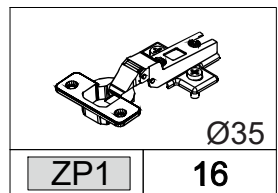
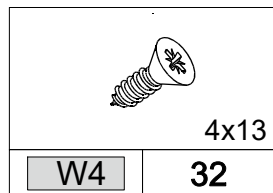
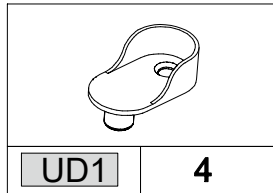
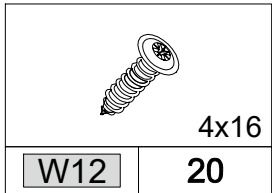
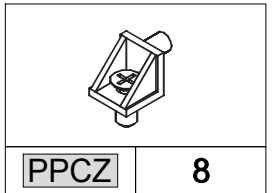
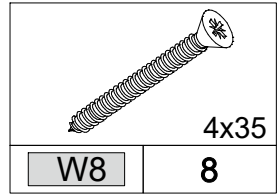
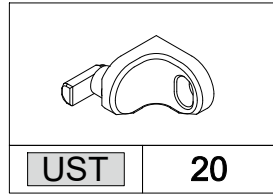
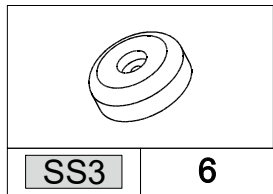
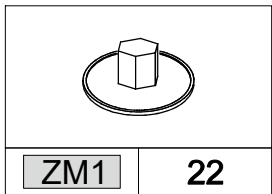
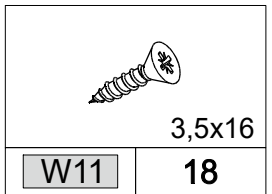
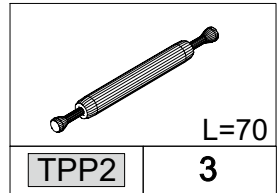
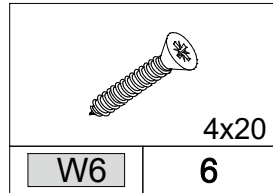
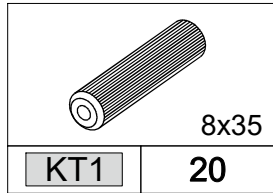
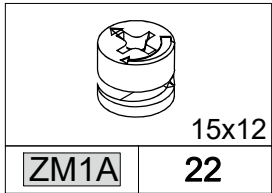
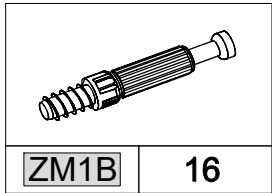
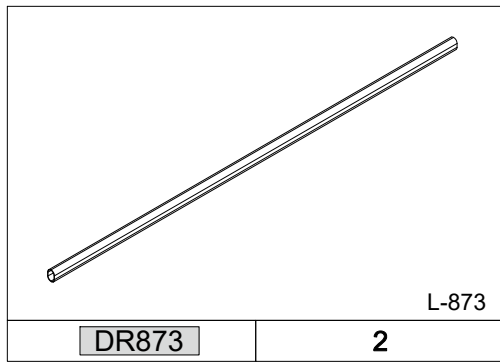
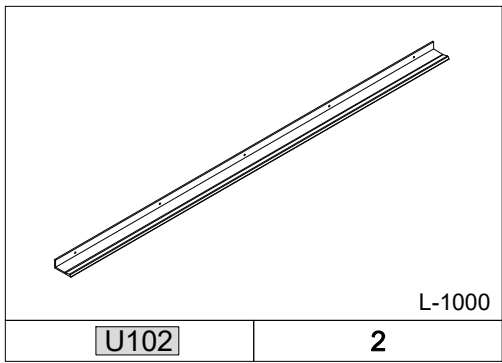

COLLI 1/6

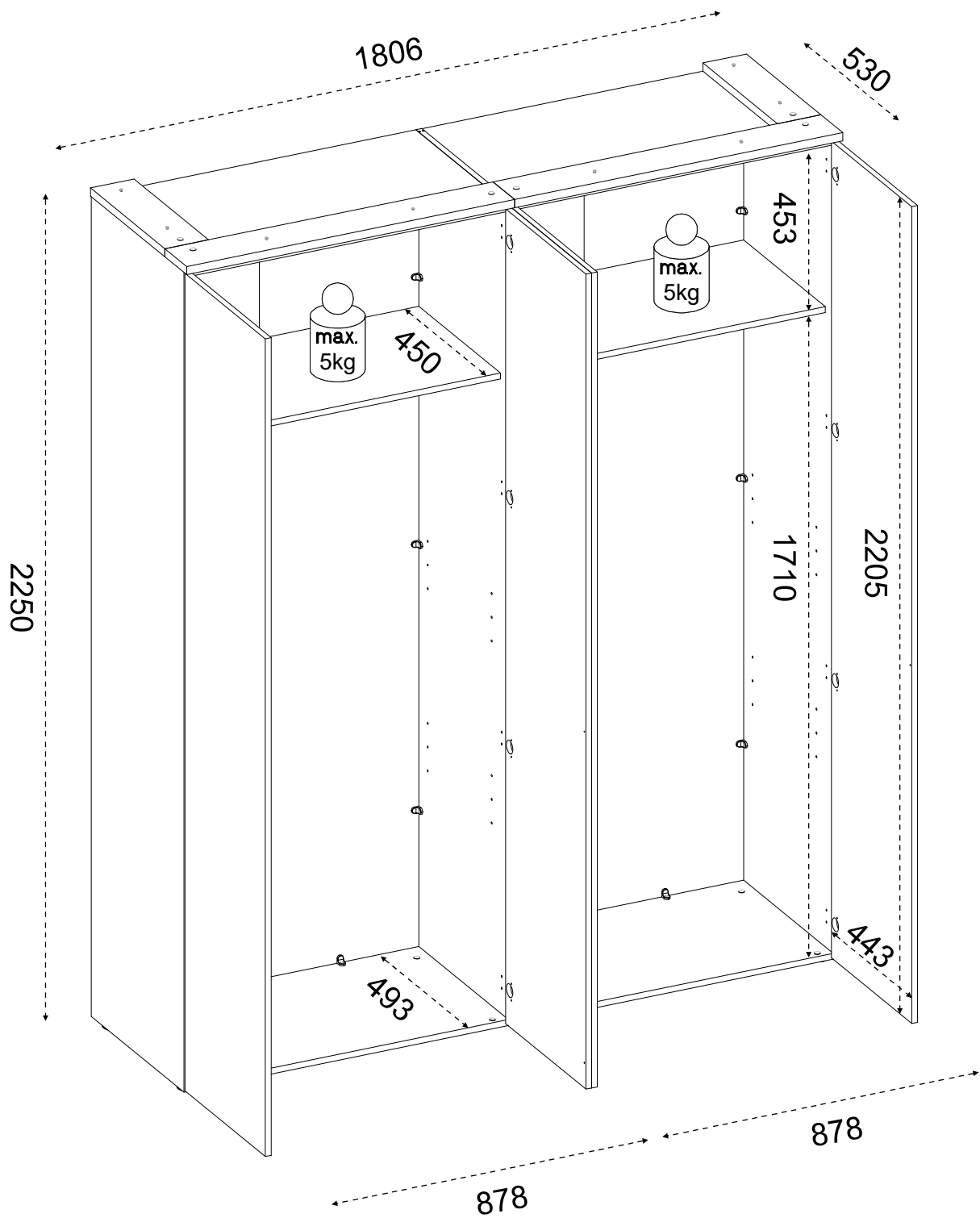

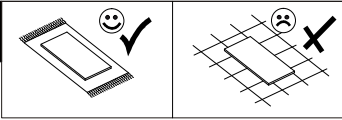

01



	15x12		8x35
ZM1A	16	KT1	16

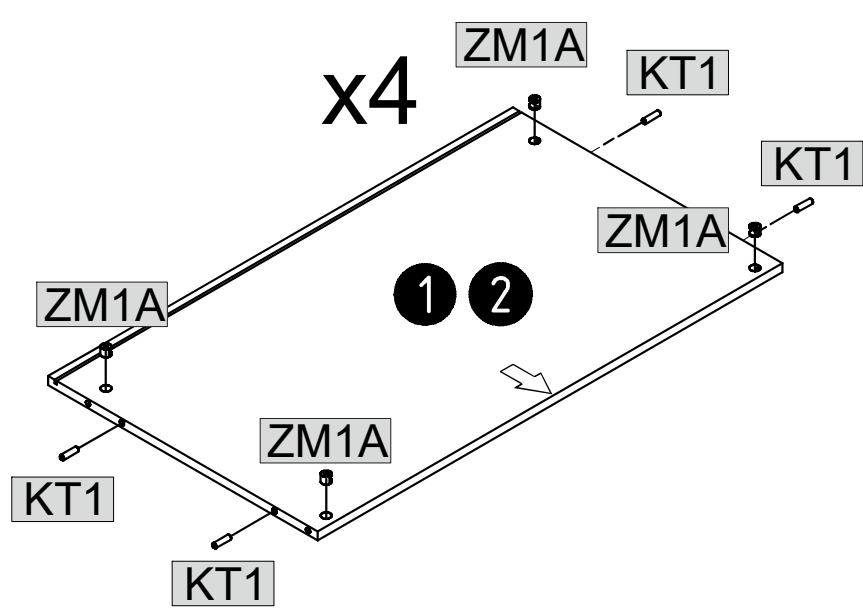
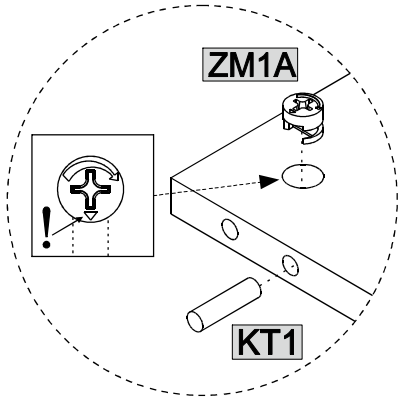

02

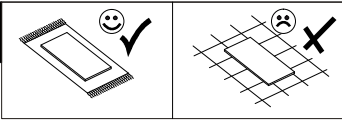

	4x20		
W6	6	SS3	6

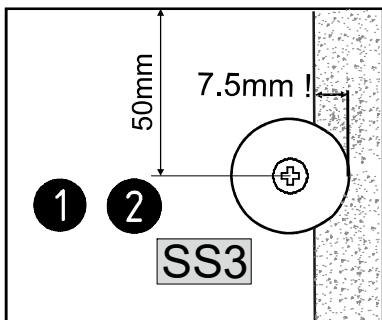
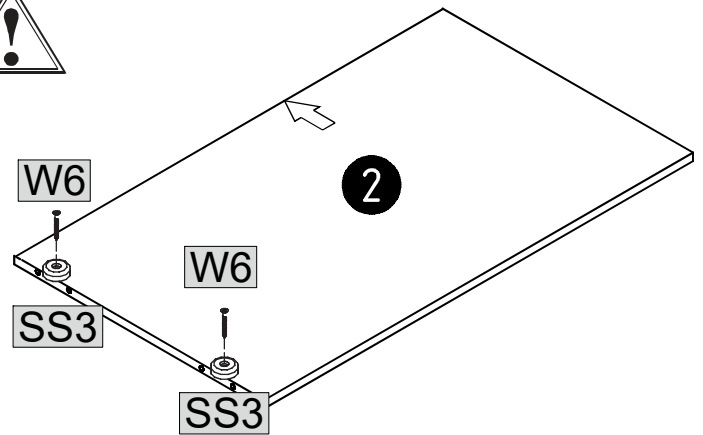
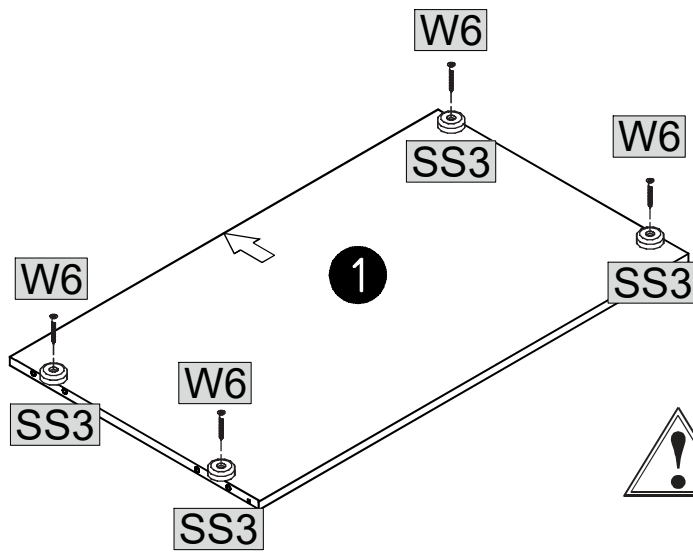

03

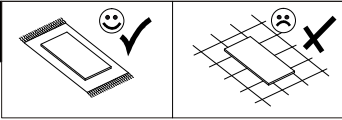

ZM1B	8	UD1	2	PPCZ	4
				ZP2	8
				W11	2
				3,5x16	
				KT1	4
				8x35	

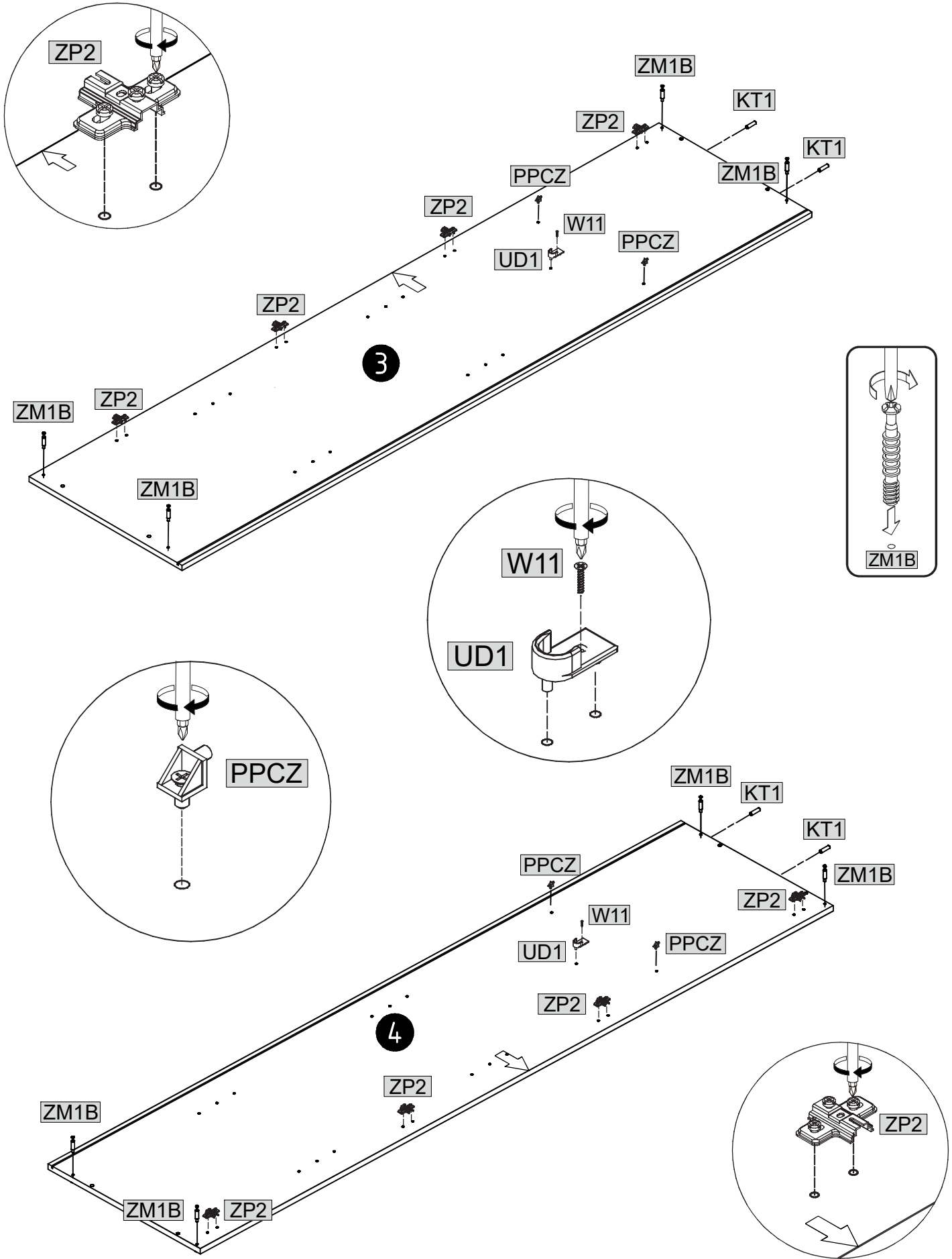

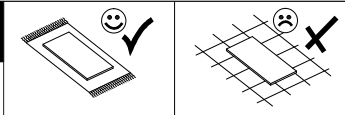

ZM1B	UD1	PPCZ	ZP2	W11
8	2	4	8	2

3.5x16

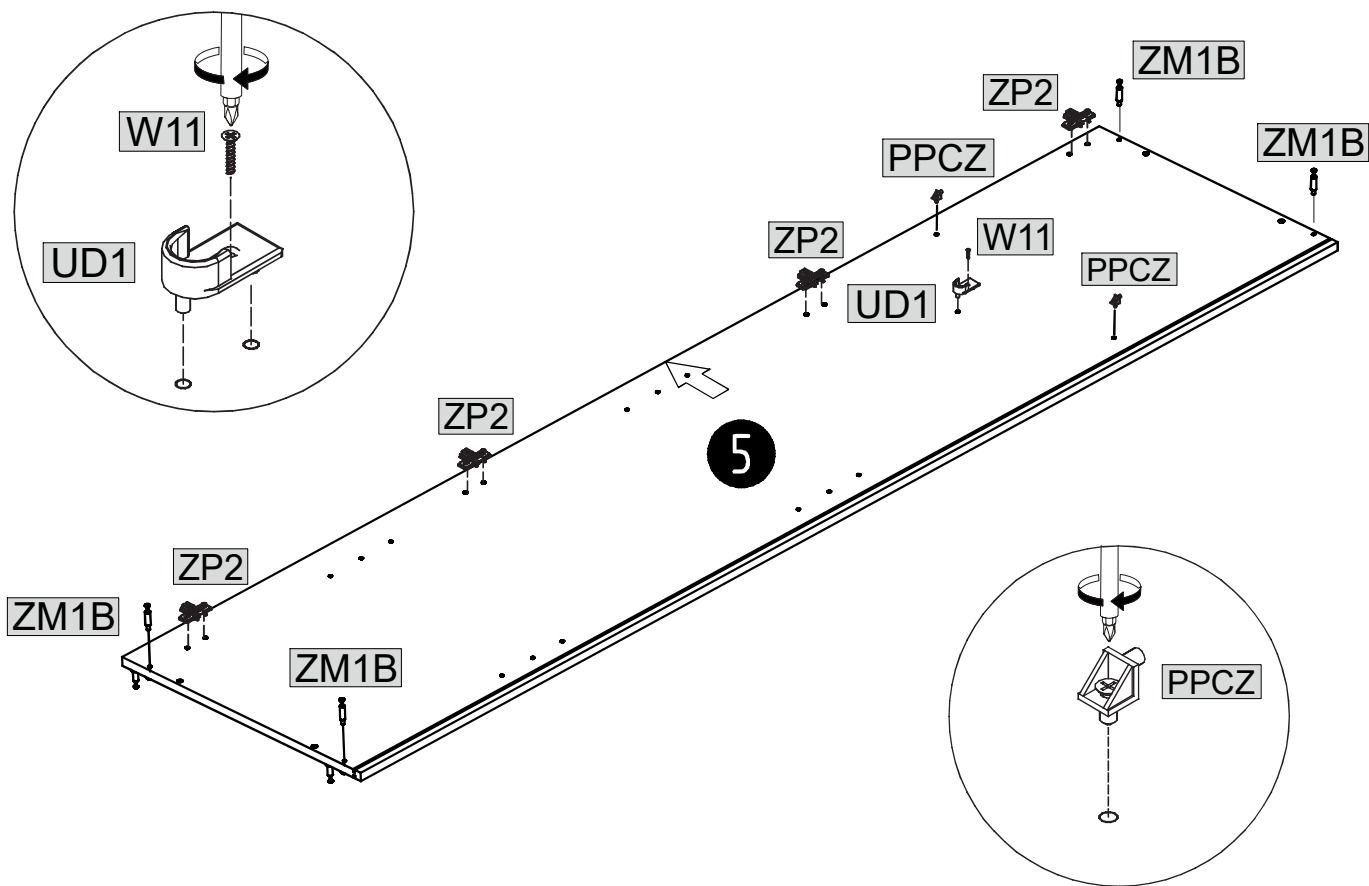
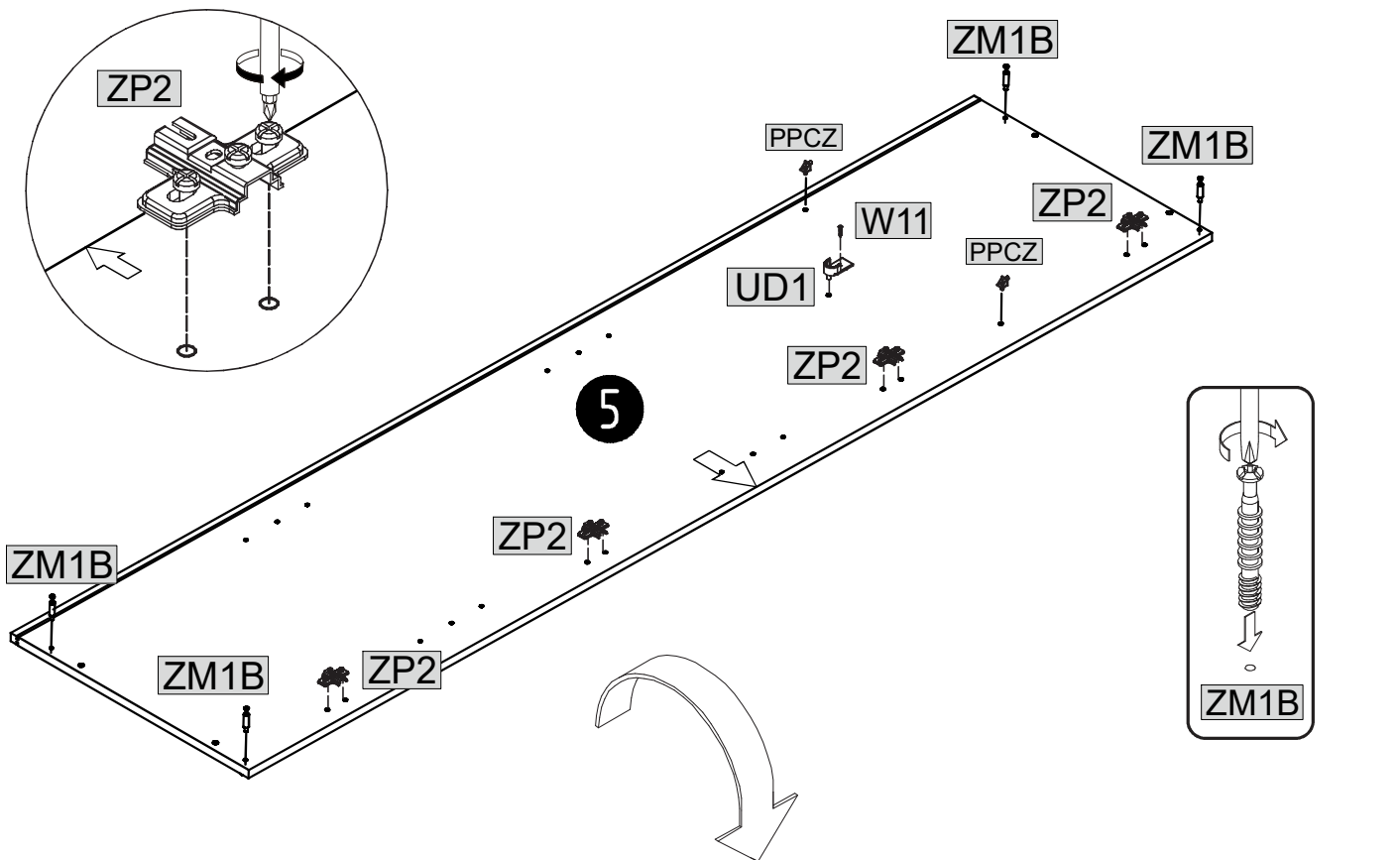

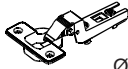
			
4x13	Ø35		
W4	32	ZP1	16

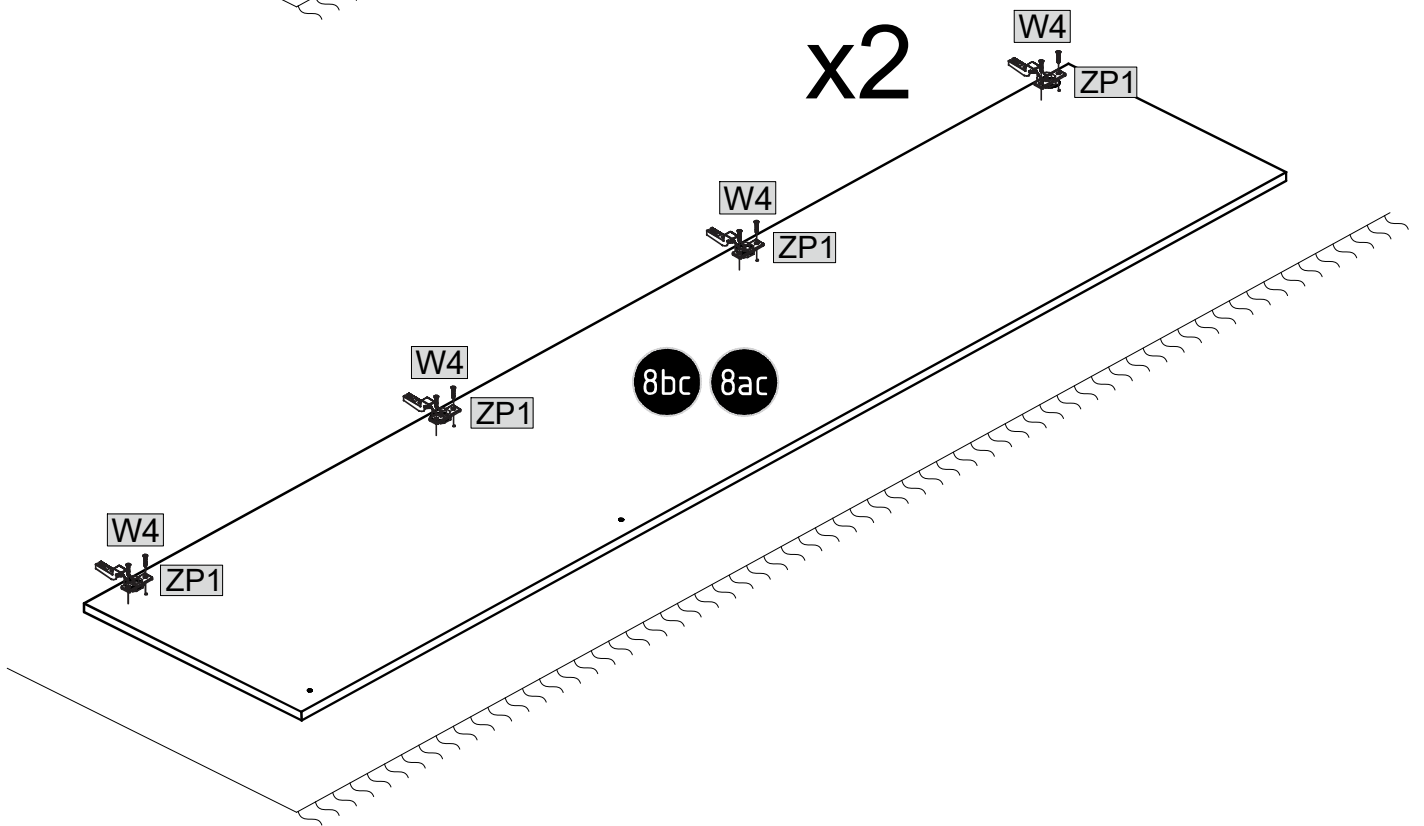
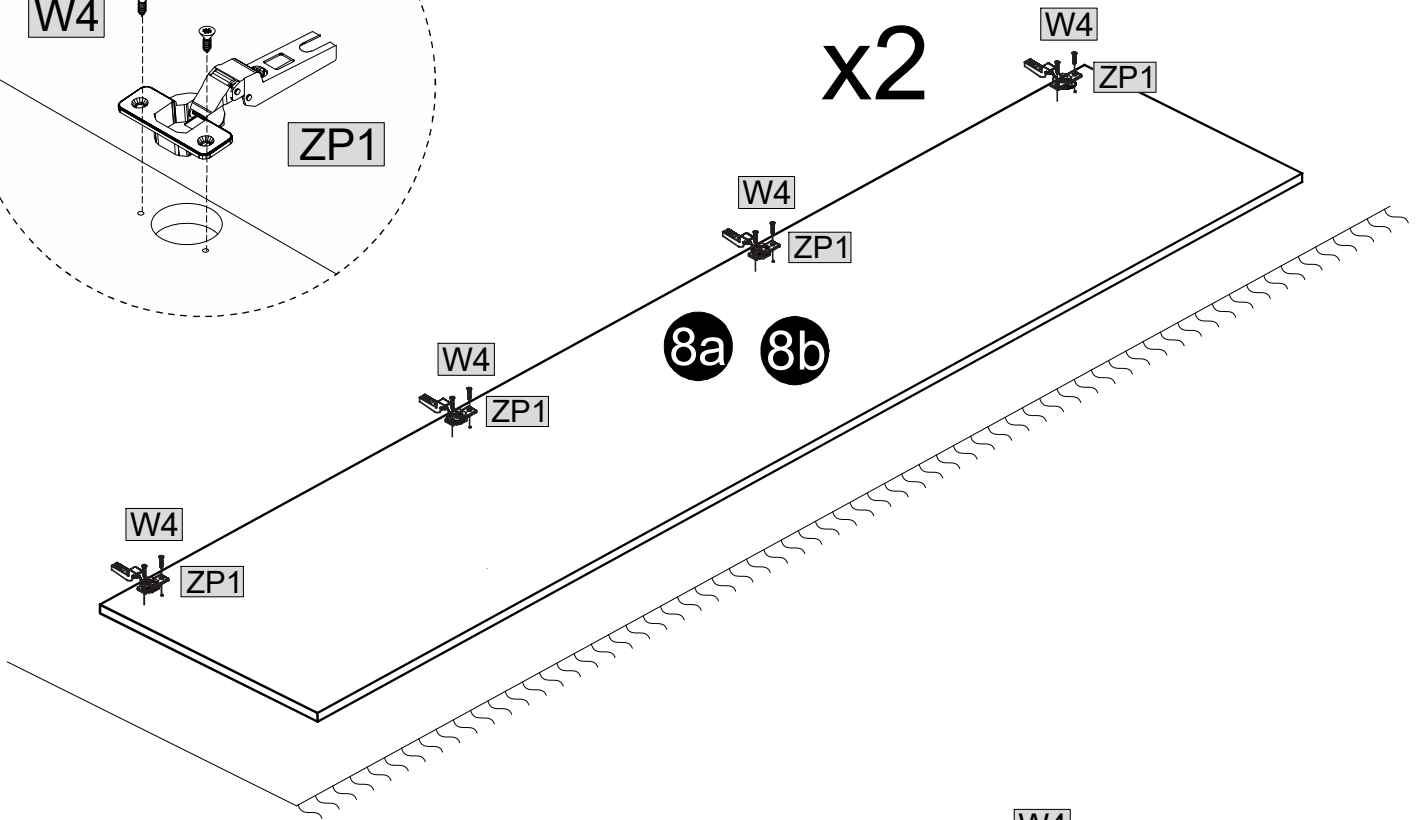
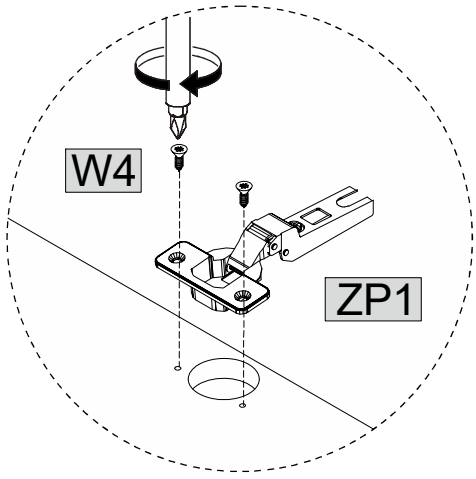

06

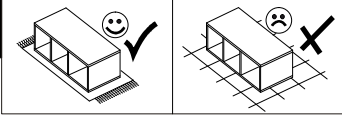

	6		3		6		6
			L=70		Ø8x60		15x12

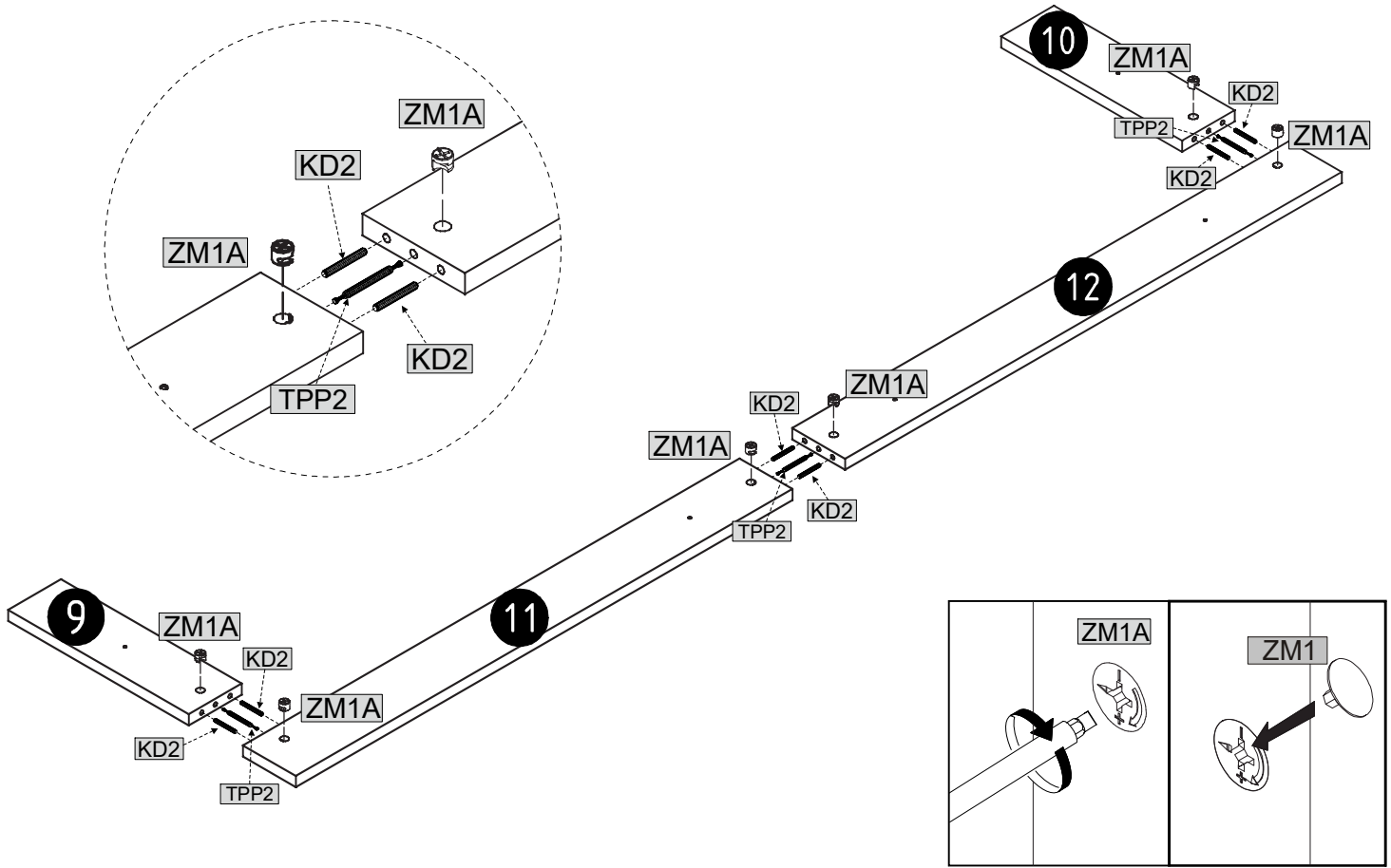

07

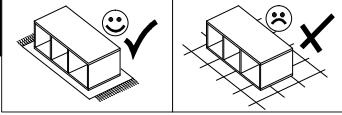

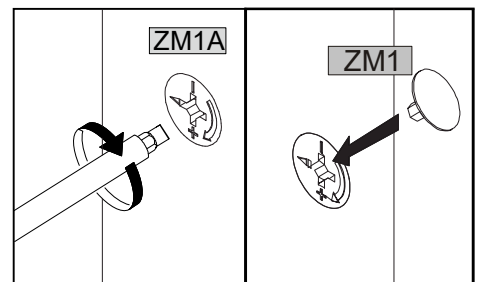
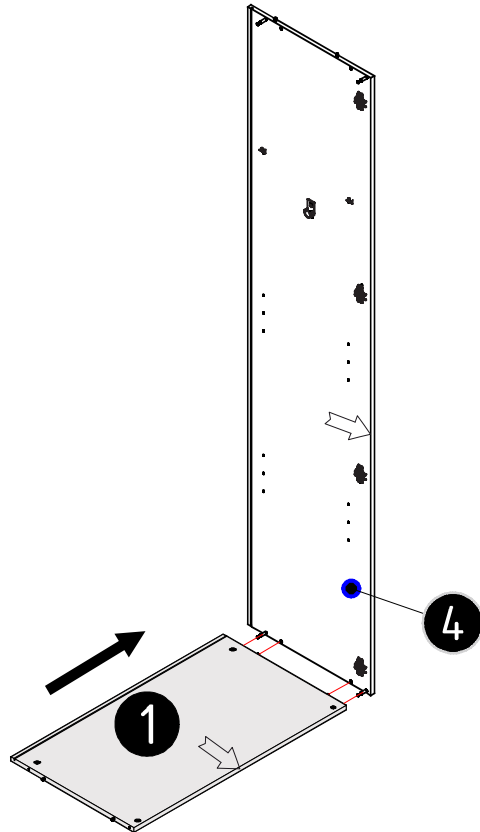

	2
--	---

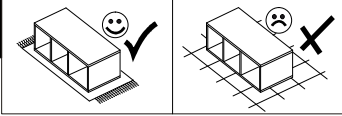

08



	4x16		
W12	5	UST	5

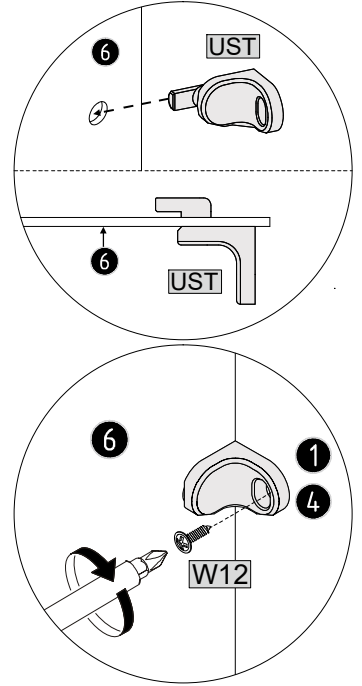
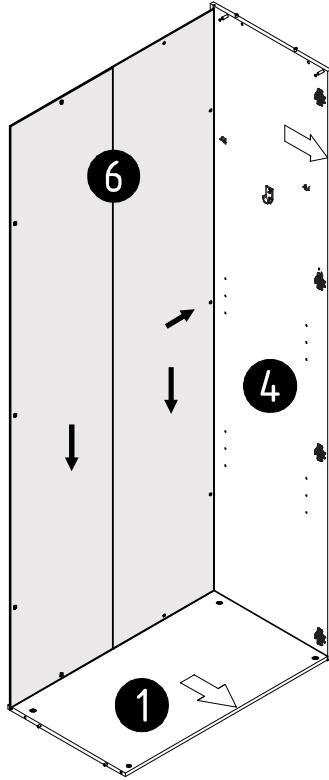

09

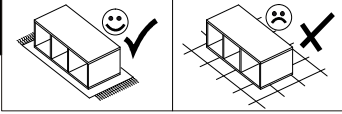

	
ZM1	2

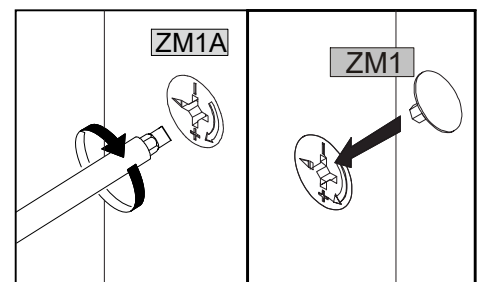
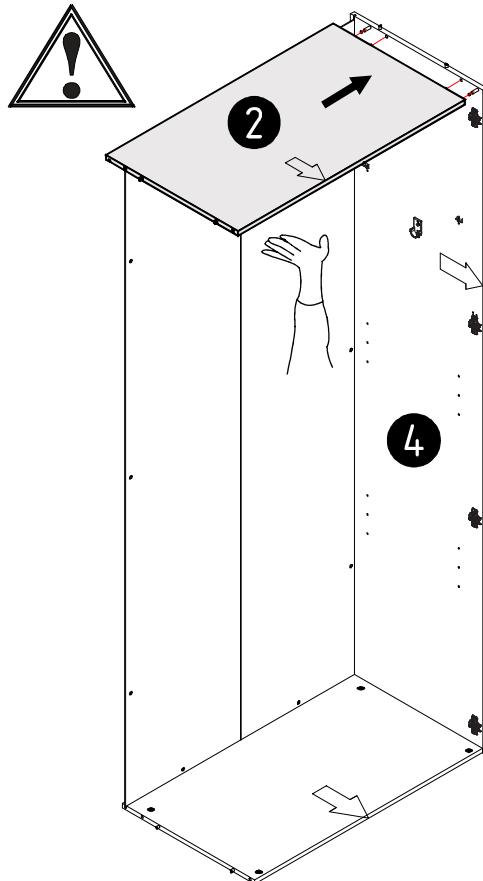

10

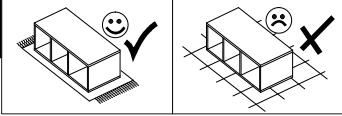

ZM1	4	W12	5	UST	5

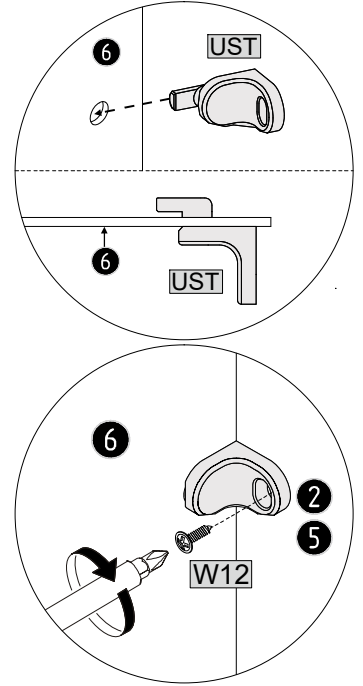
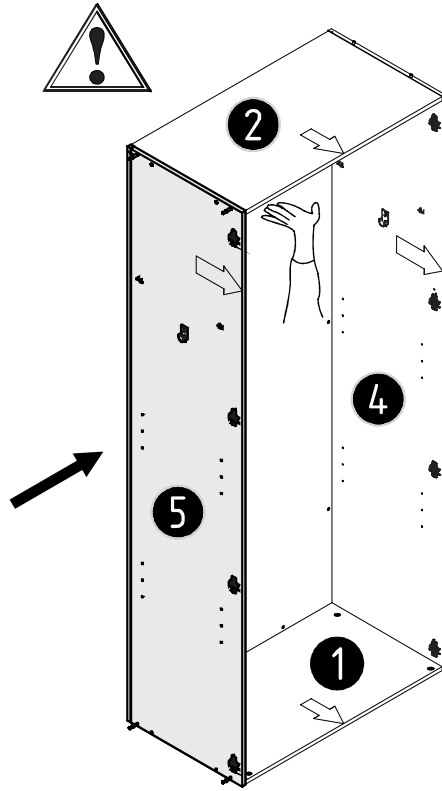
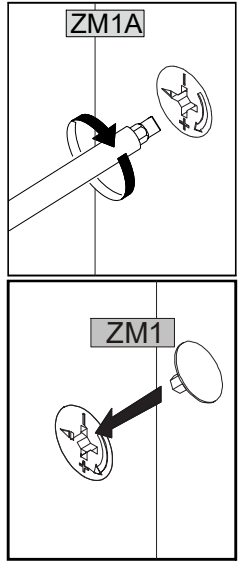

11

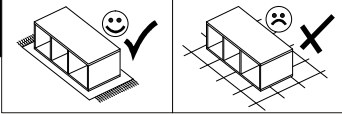

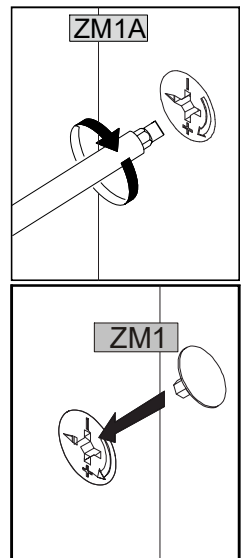
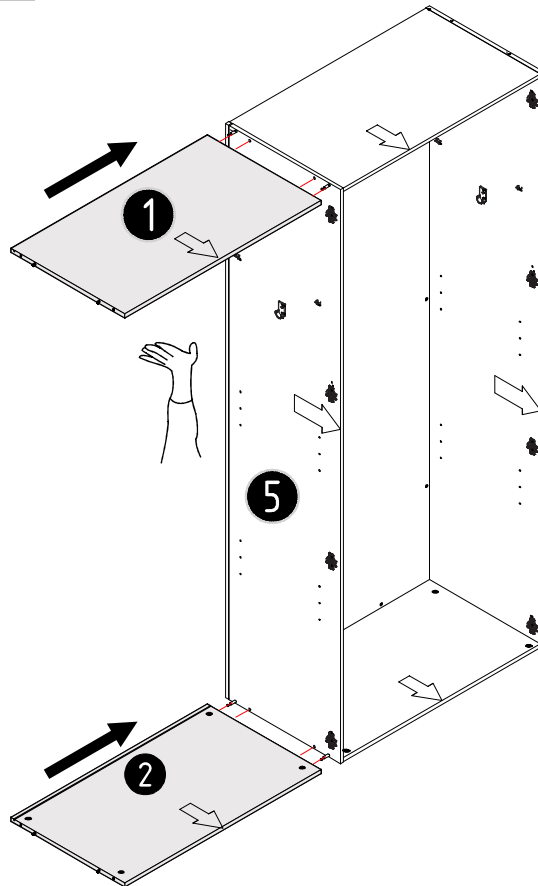

ZM1	4

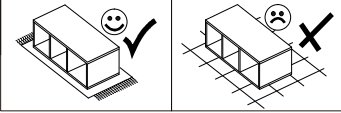

12



			
4x16			
W12	7	UST	7

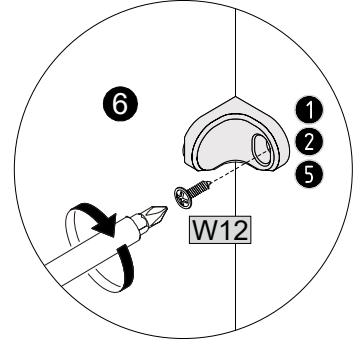
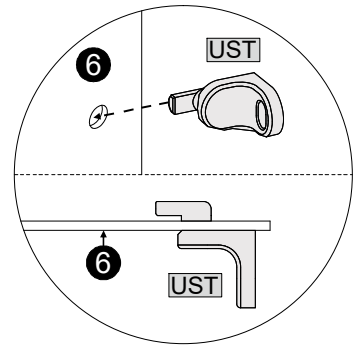
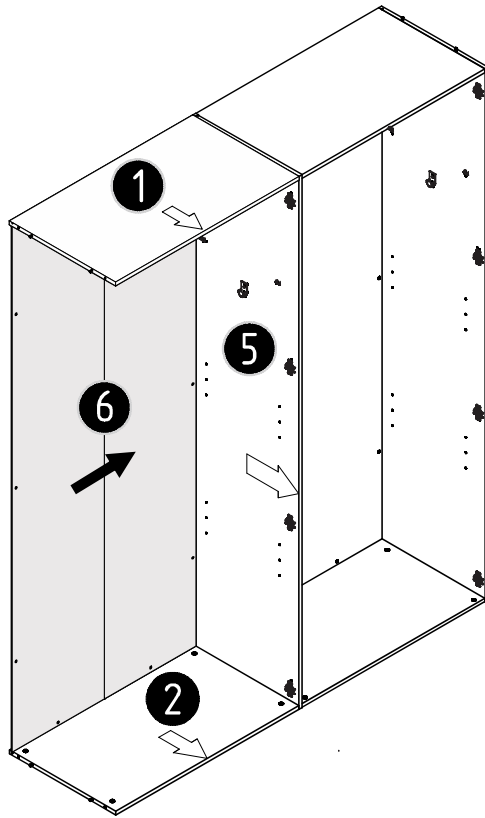

13

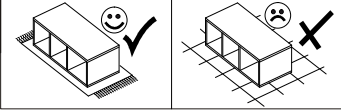

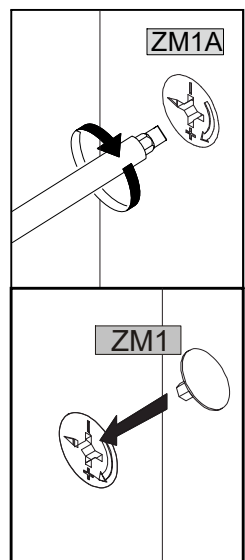
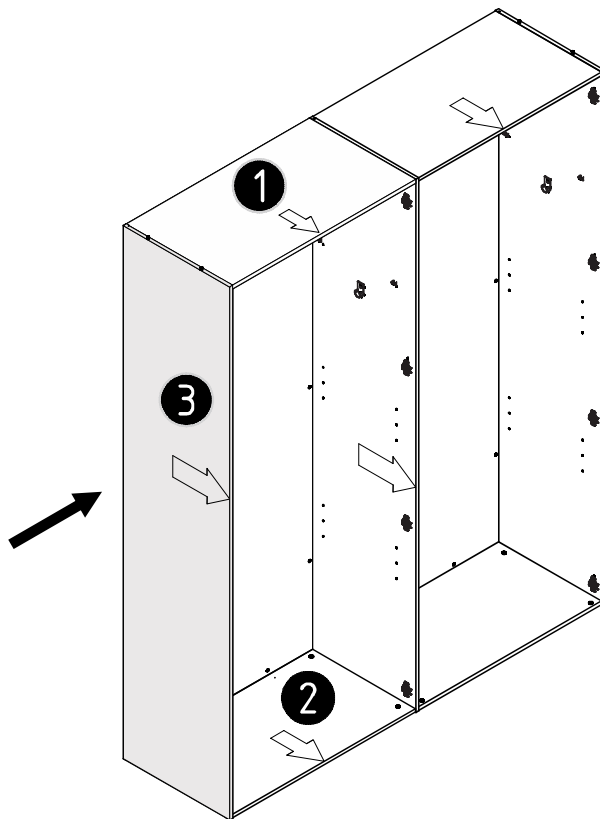

	
ZM1	4

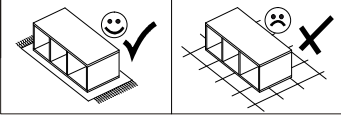

14



	4x16		
W12	3	UST	3

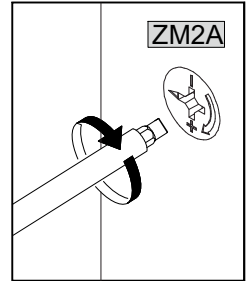
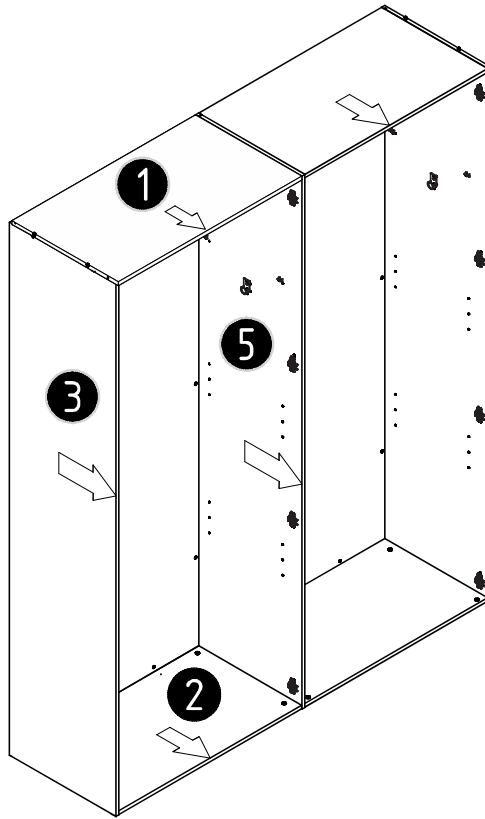
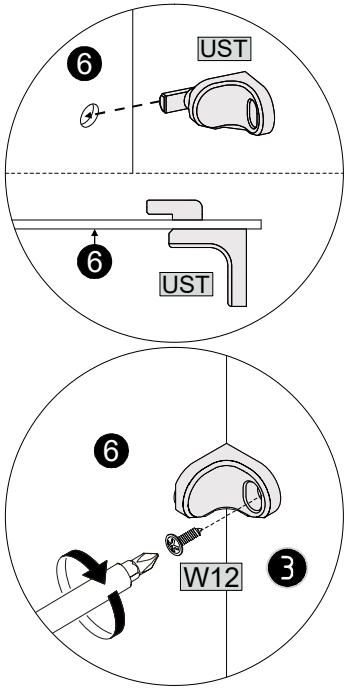



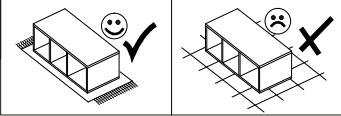

15

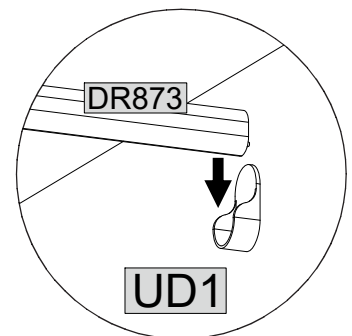
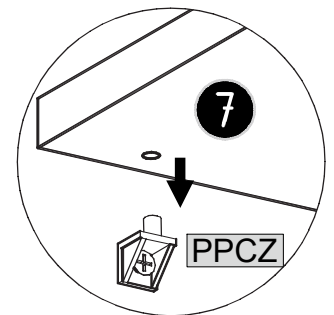
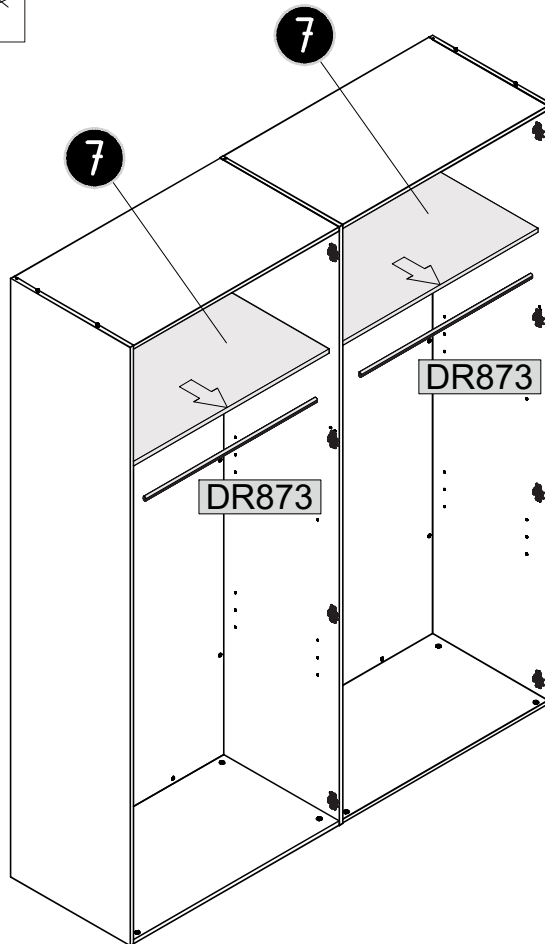

	L-873
DR873	2

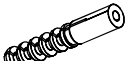

	6x50		3,5x16		10x50		
KRL1	2	W11	4	KRW1	2	KS1	2

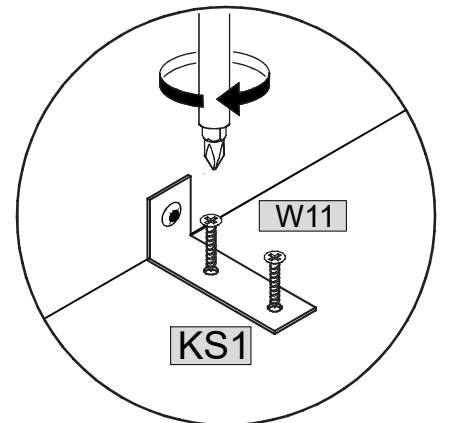
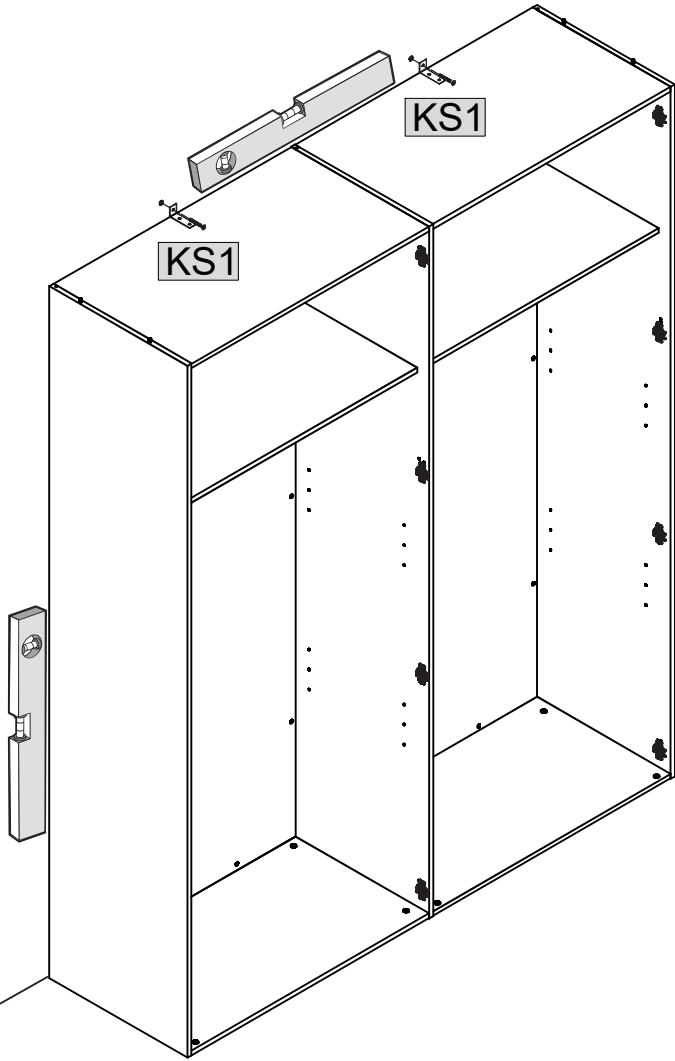
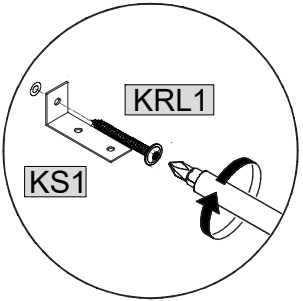
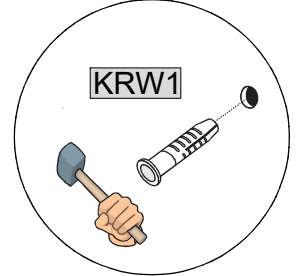
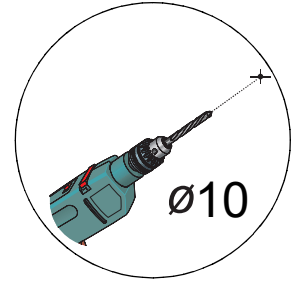
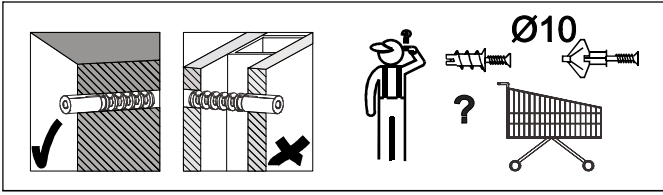

17

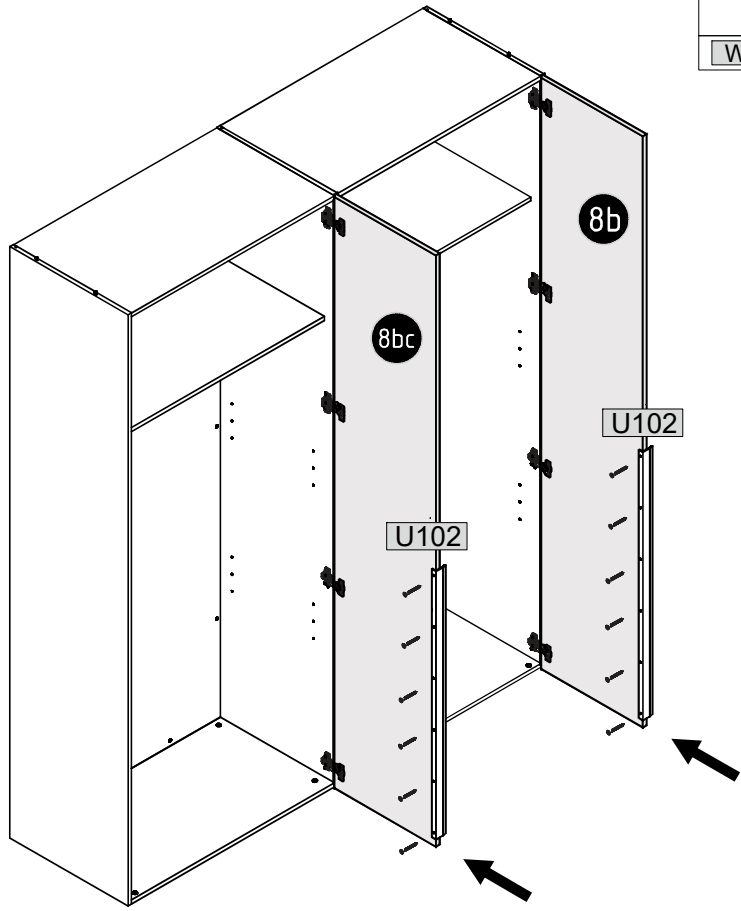
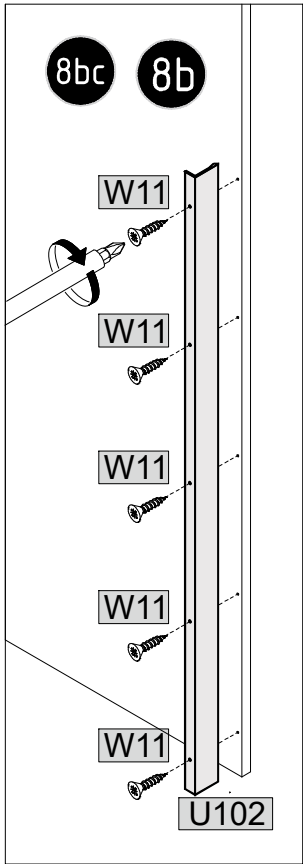

3,5x16		L-1000	
W11	10	U102	2

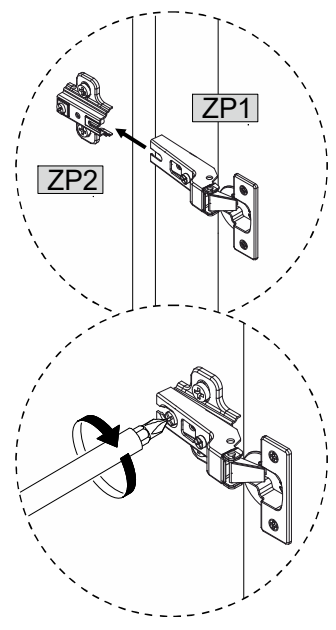

18

