



# WC-Waschmaschinenüberbau 70-175-.-3 1/12

**meble**  
**okmed**  
**denko**

wyprodukowano dla / made for / produziert für  
**BEGA GRUPPE**  
producent: **MEBLE OKMED POLAND**



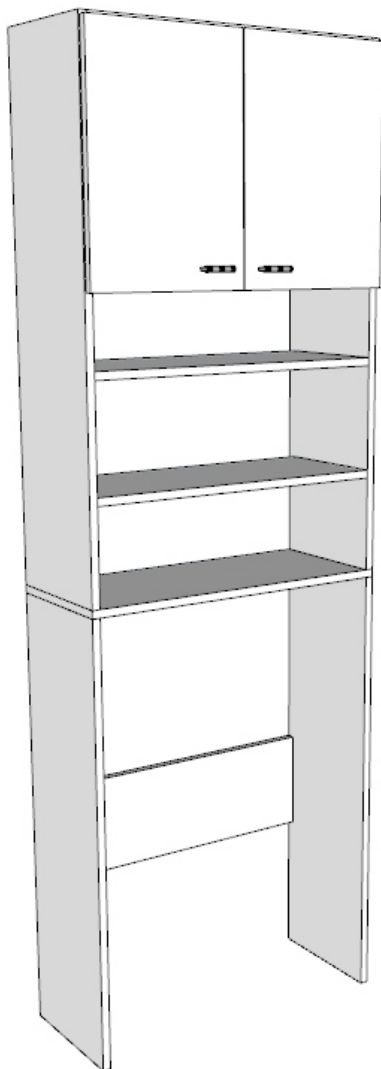
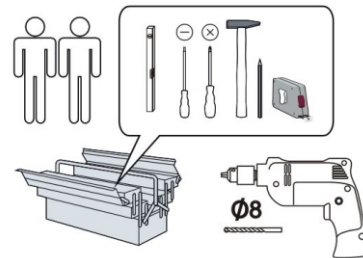



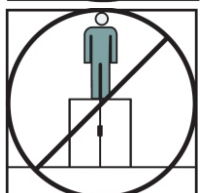
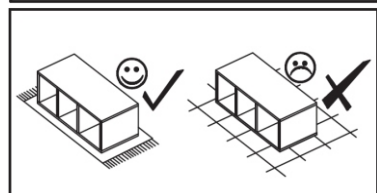
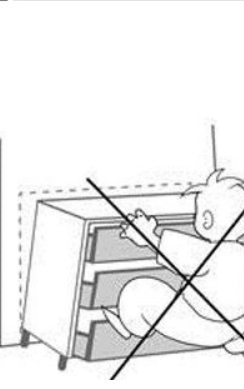
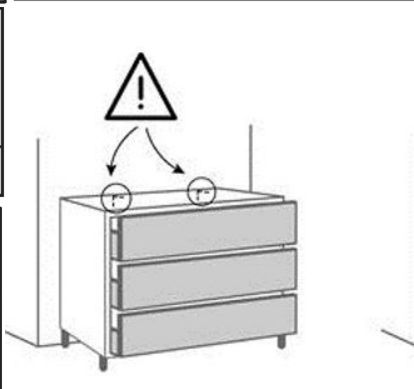
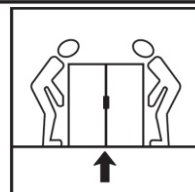
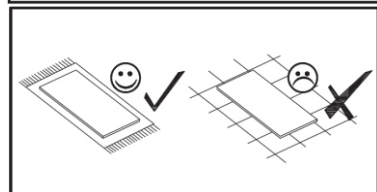
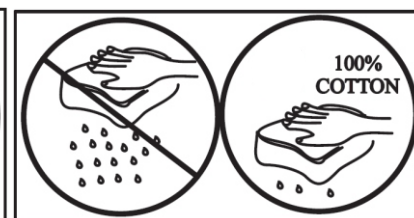
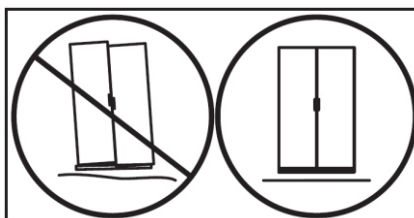
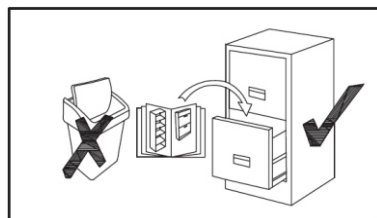
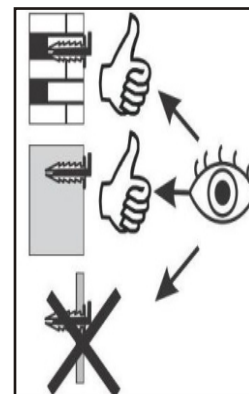

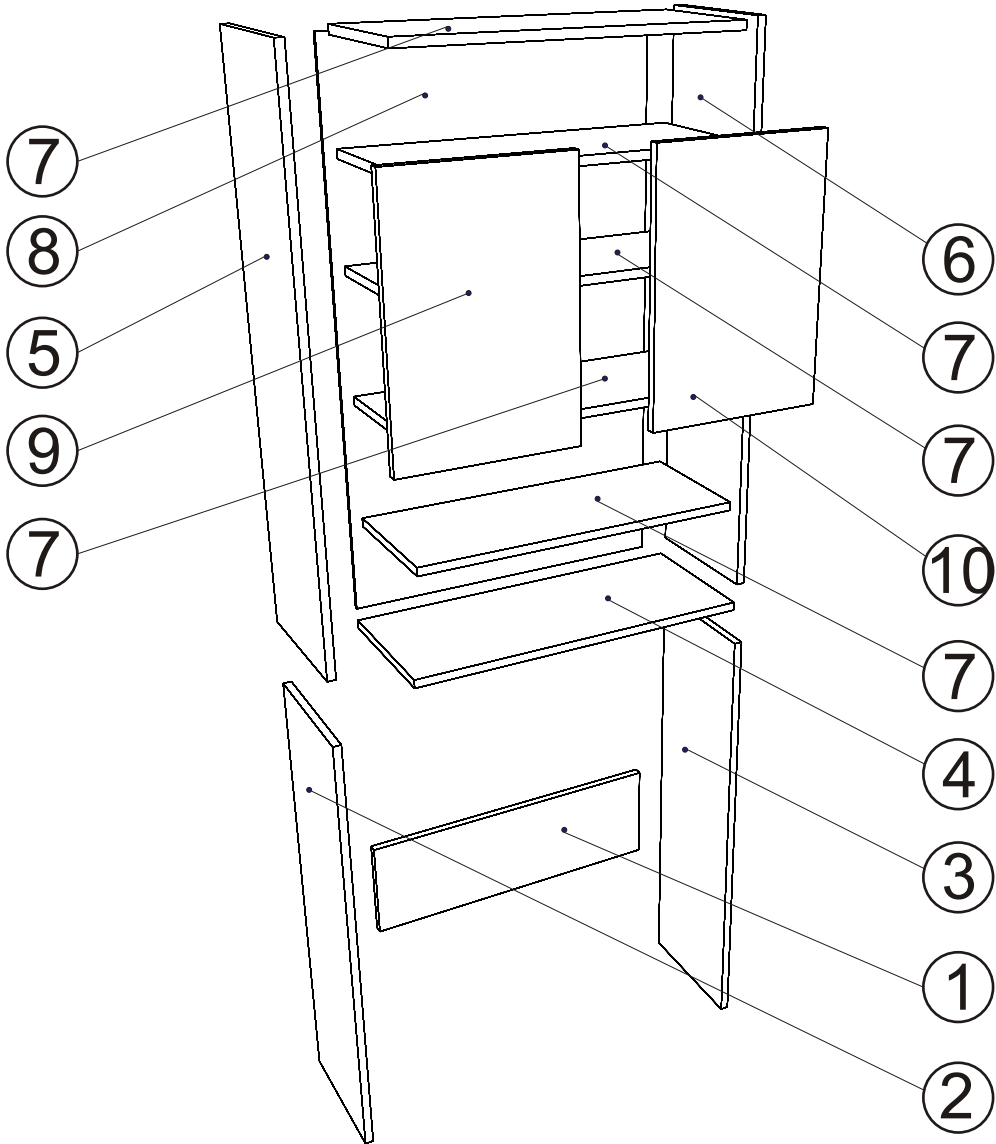









**BEGA**  
GRUPPE



④	16x650x210	1
⑤	16x1040x210	1
⑥	16x1040x210	1
②	16x900x210	1
③	16x900x210	1
①	16x617x200	1
⑦	16x617x192	5
⑨	16x321x458	1
⑩	16x321x458	1
⑧	3x1045x317	1





KD1  ø8x35 x24	KD2  8x60 x4	ZM1  ø16 x14	ZM1A  x18	ZM1B  x14	TPP3  L=86 x2	W4  ø4x13 x8	ZMP  x4	ZMP1  x4
KK1  x1	S1  x8	KRW1  x1	KS1  x1	W11  ø3,5x16 x2	W1  ø3x16 x6	U28  x2	WU  ø3,5x27 x4	SG2  x4

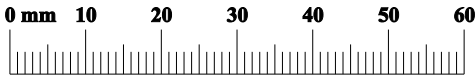

01

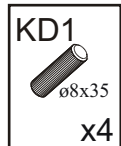
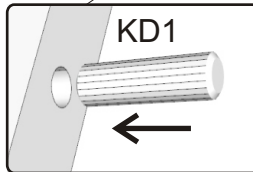
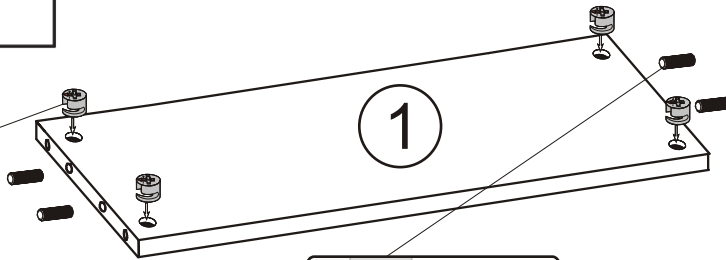
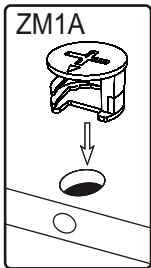
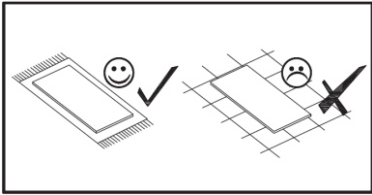

02

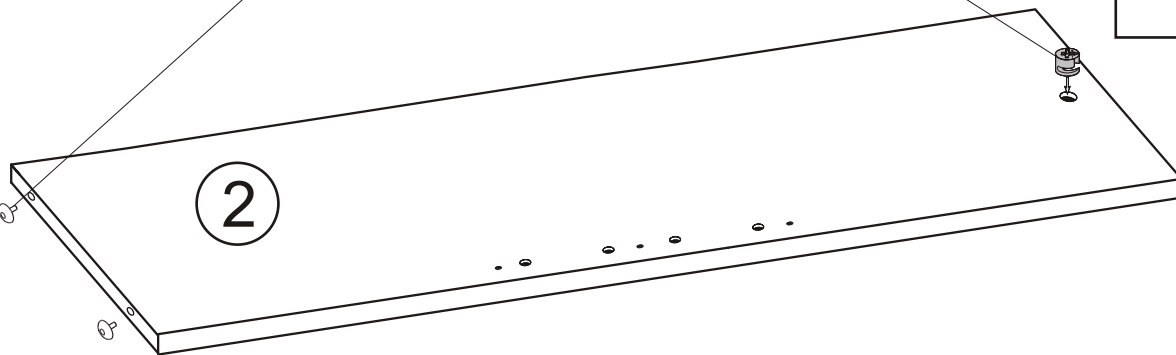
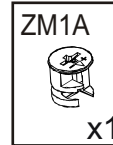
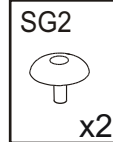
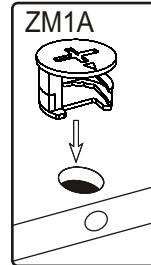
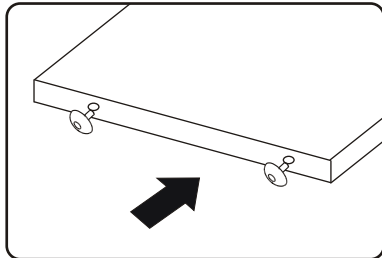
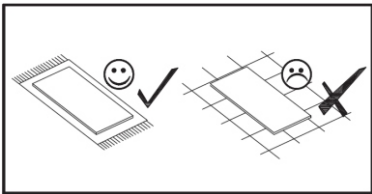

03

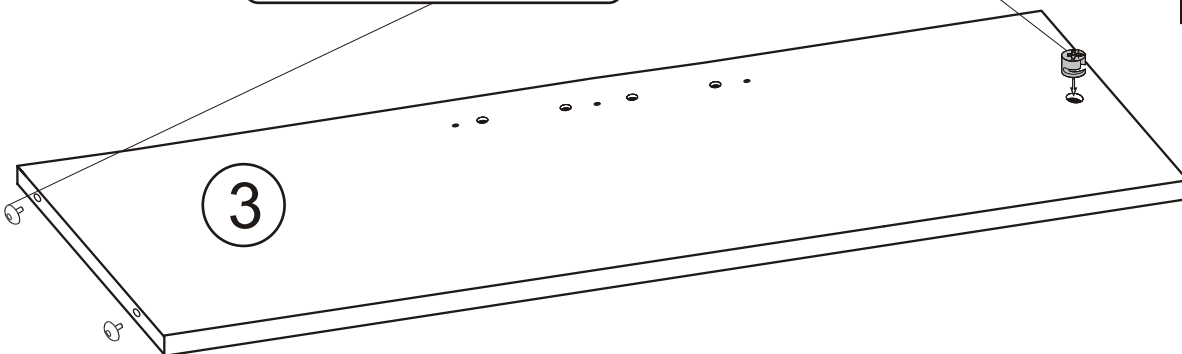
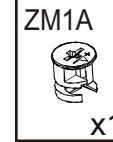
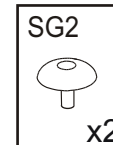
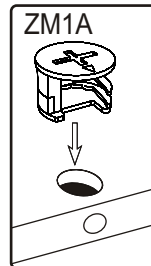
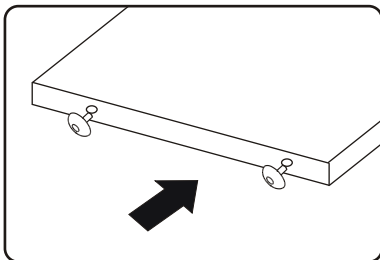
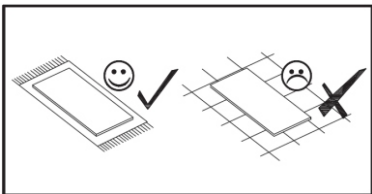

04

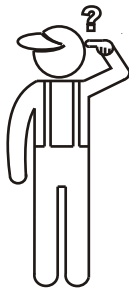
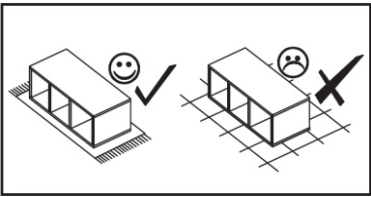

1/2 ?



1

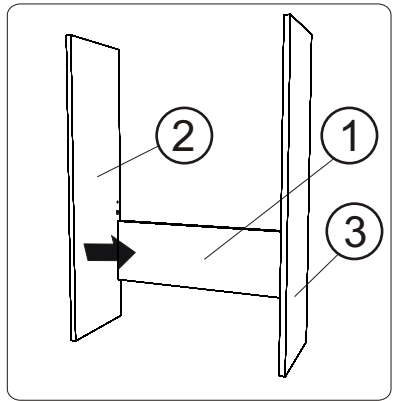
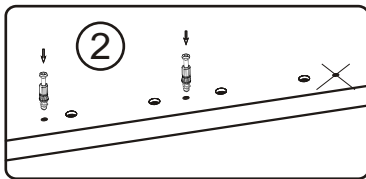
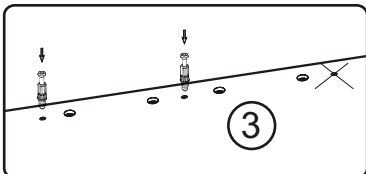
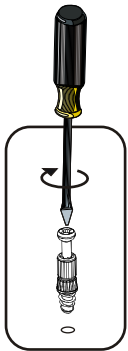

2

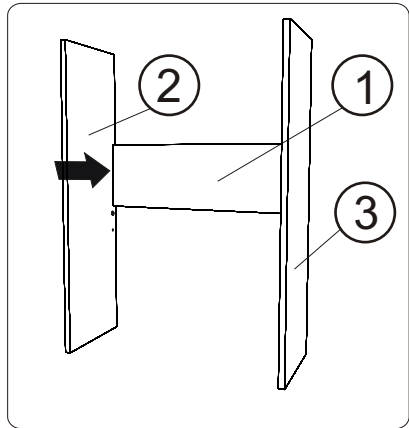
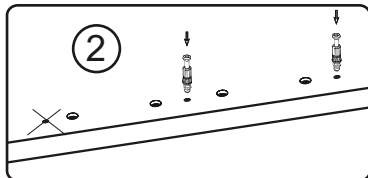
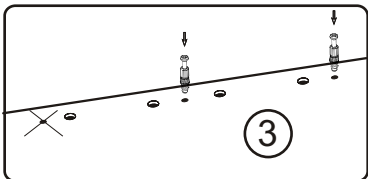

05

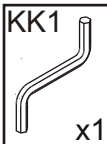
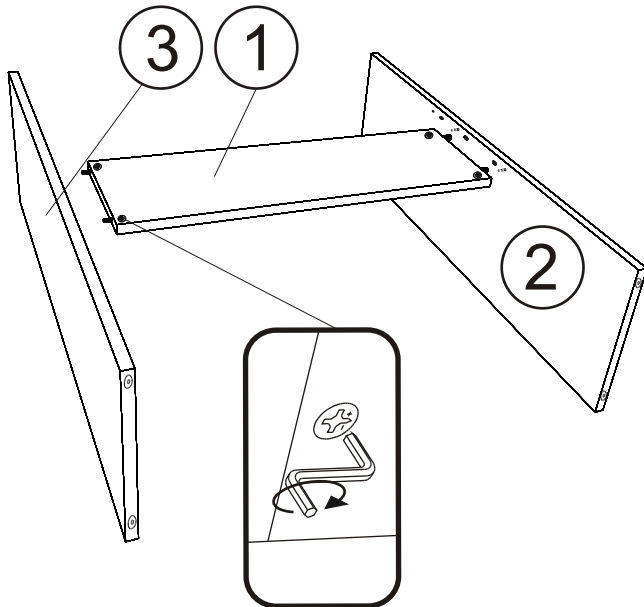
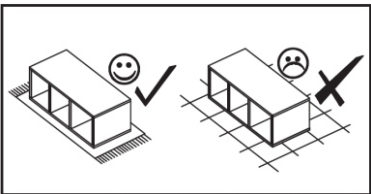

06

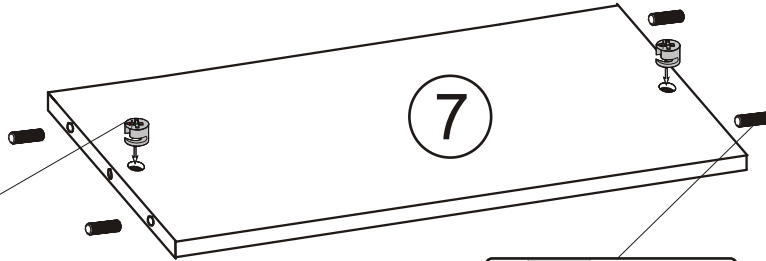
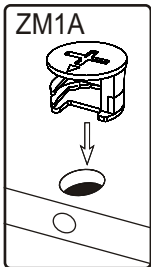
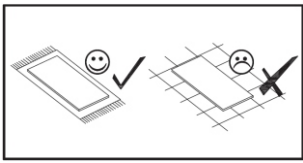

x5

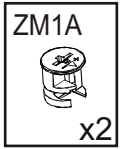
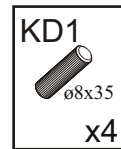
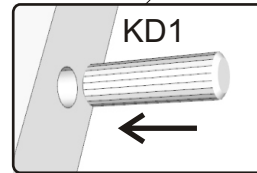

07

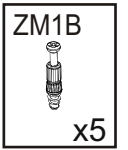
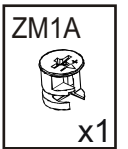
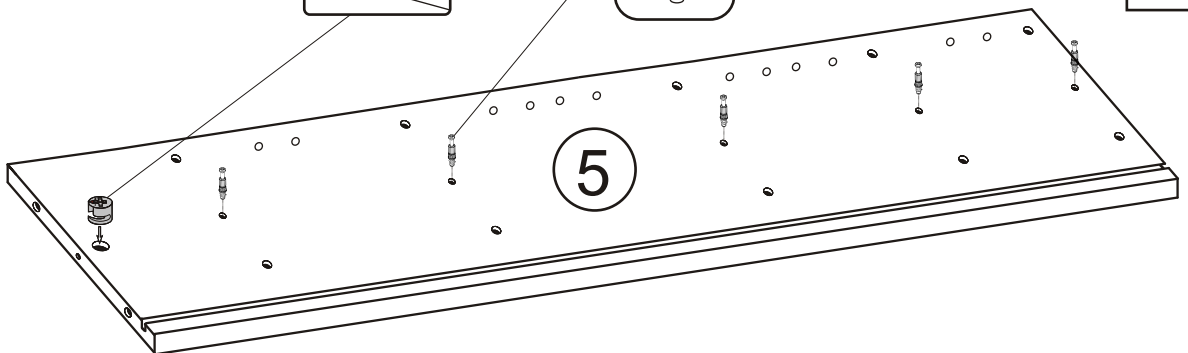
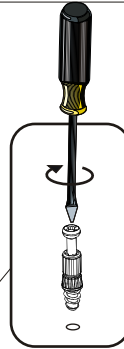
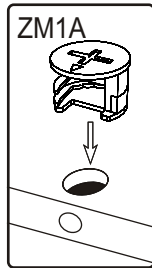
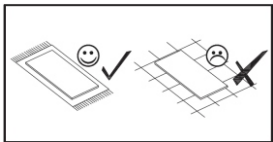

08

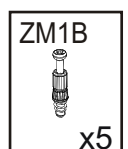
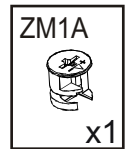
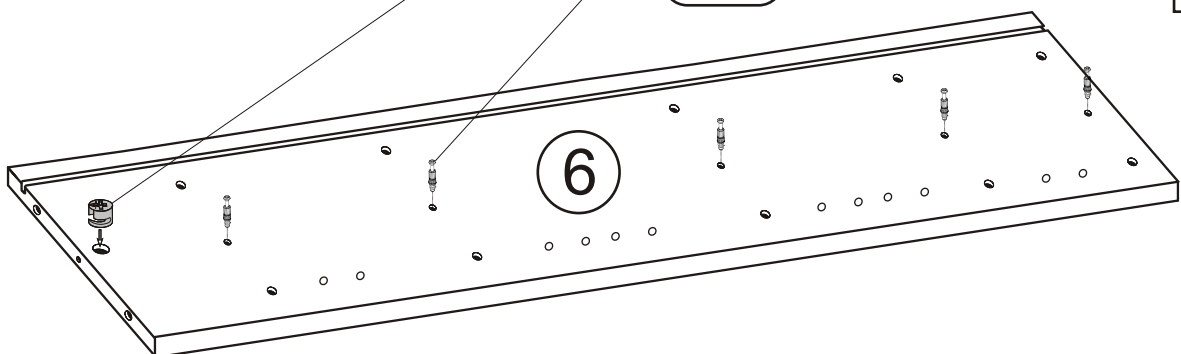
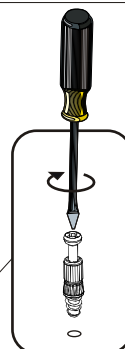
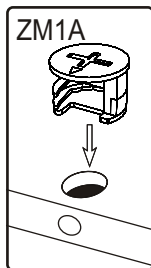
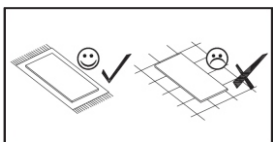

09

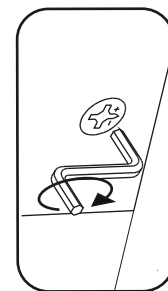
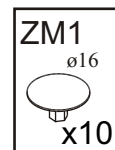
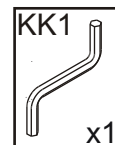
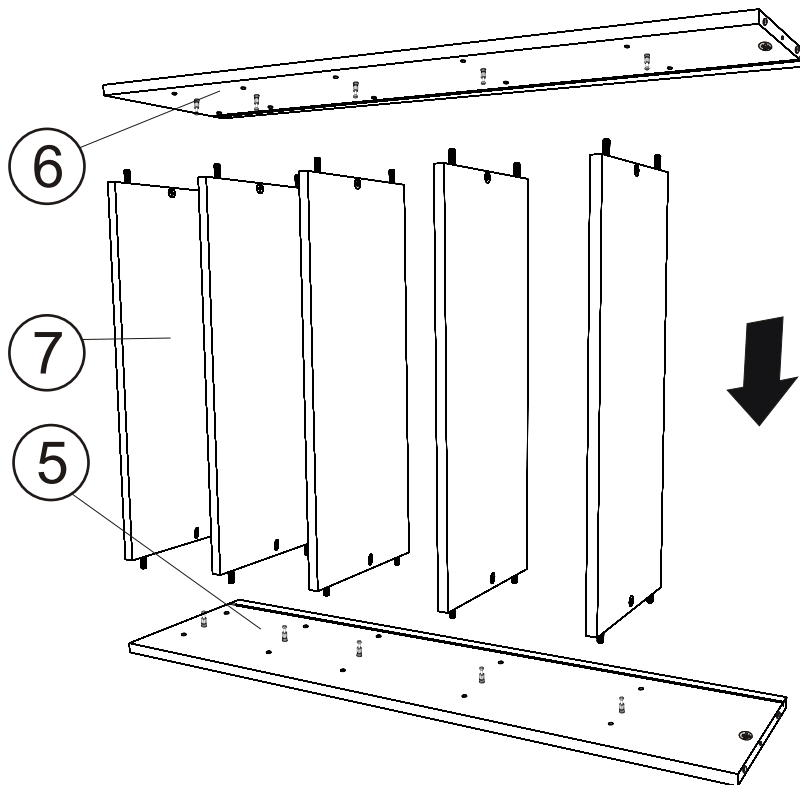
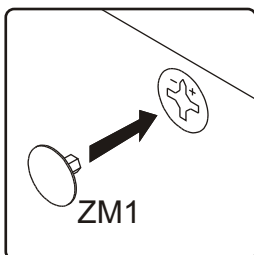
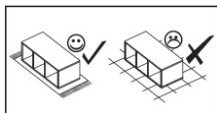

10

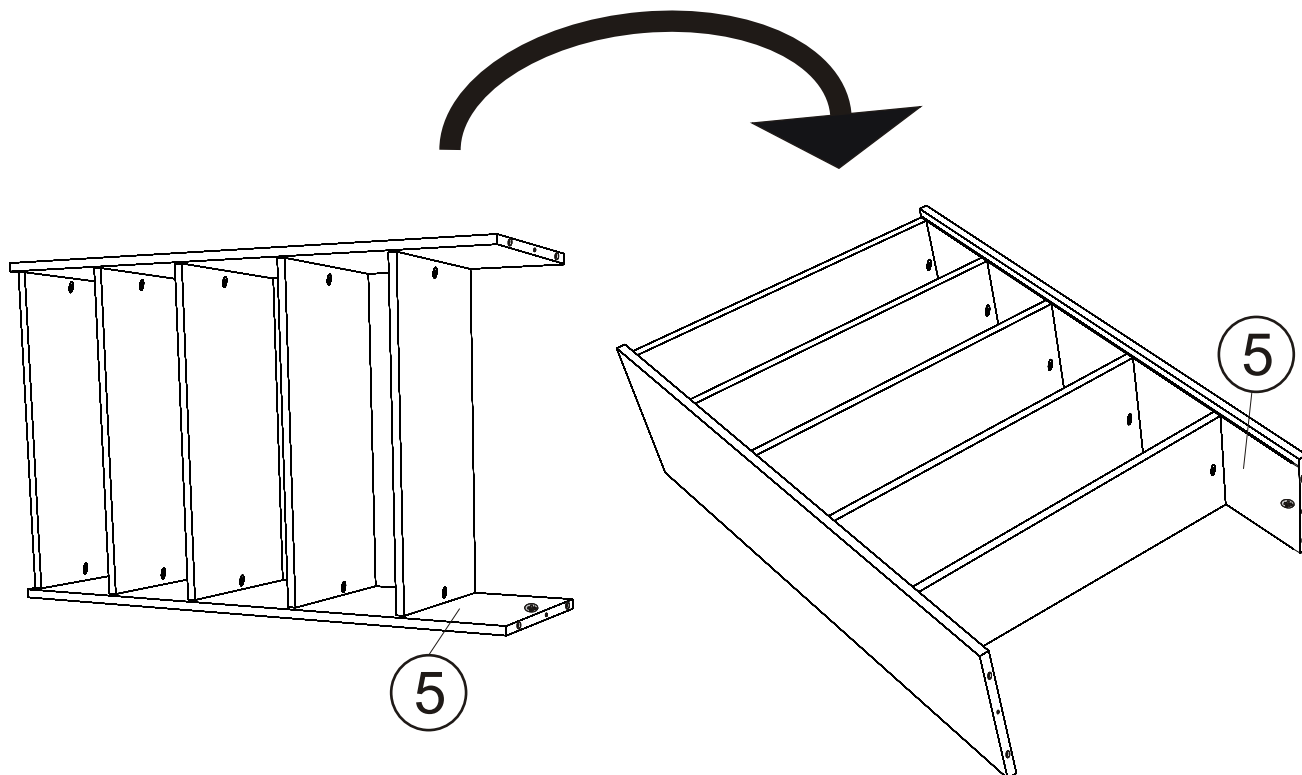
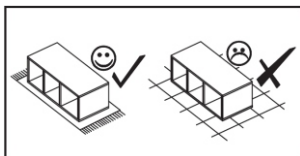

11

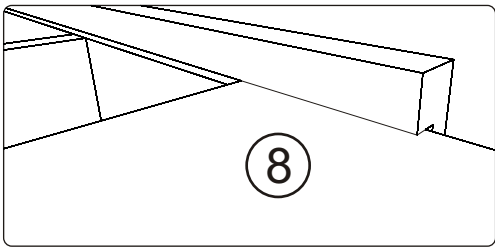
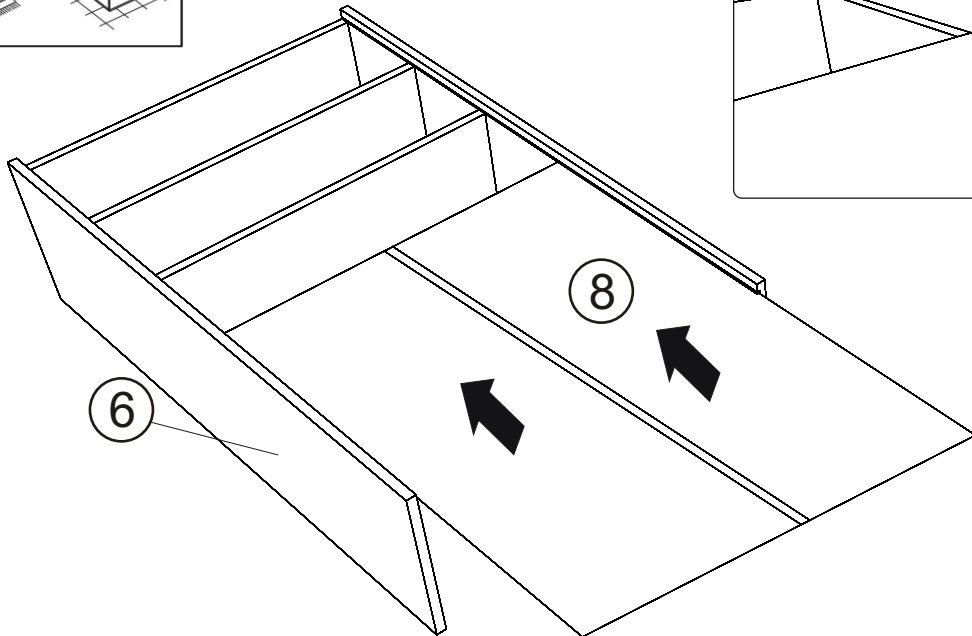
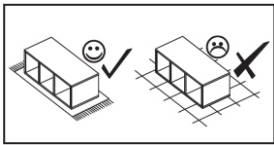

12

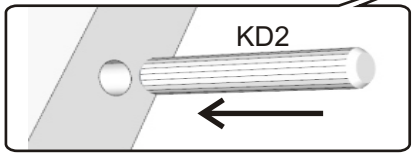
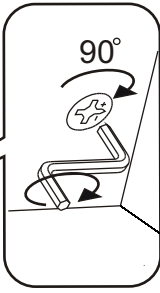
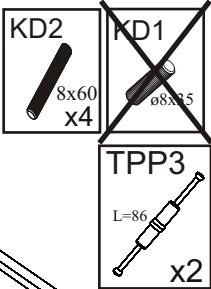
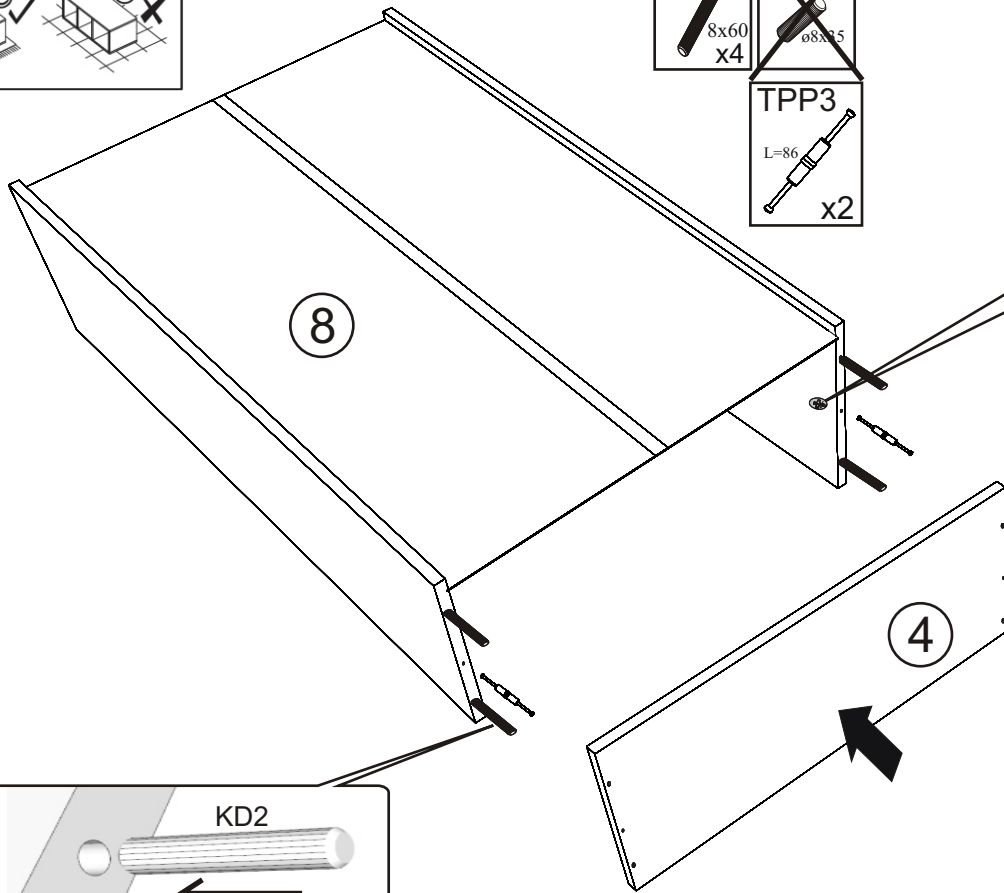
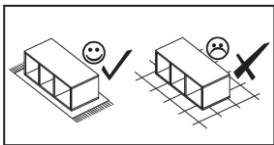

13

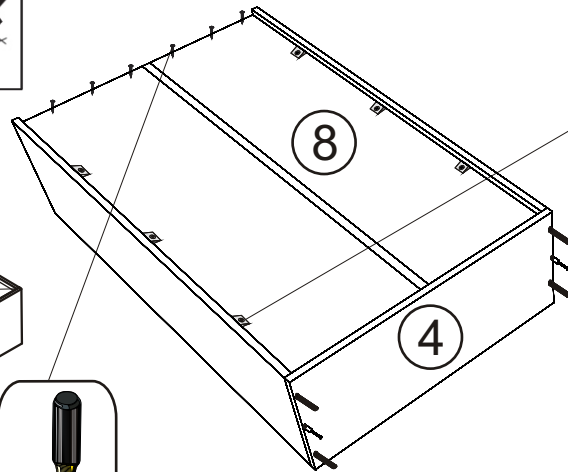
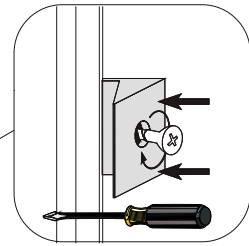
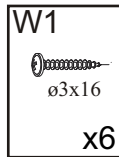
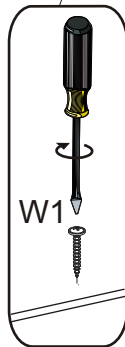
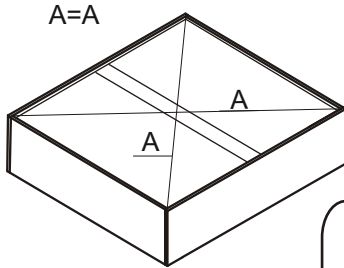
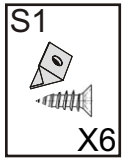
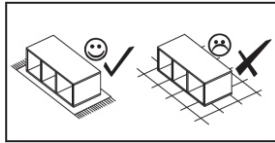

14

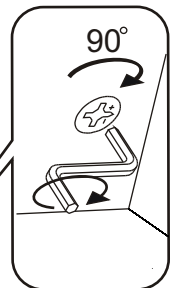
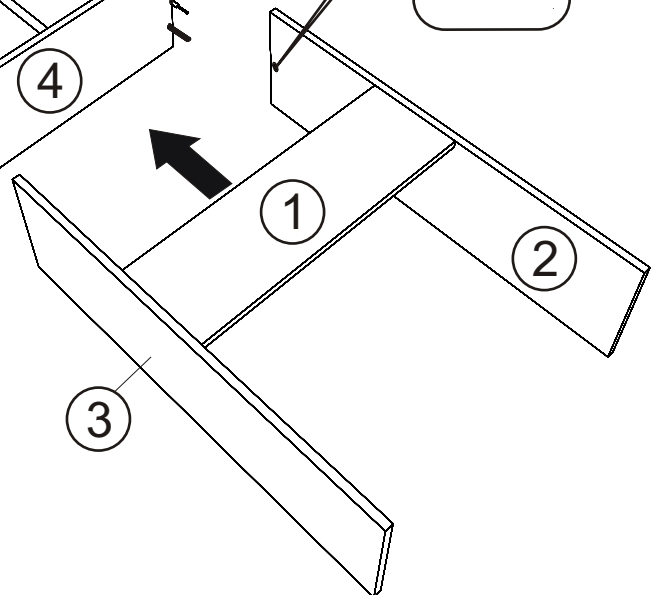
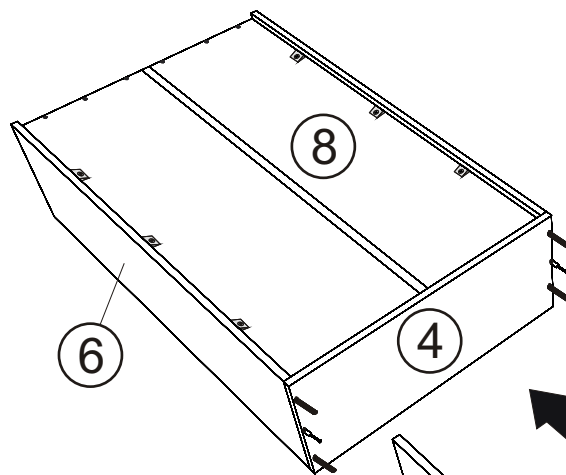
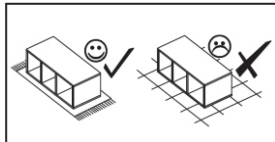

15

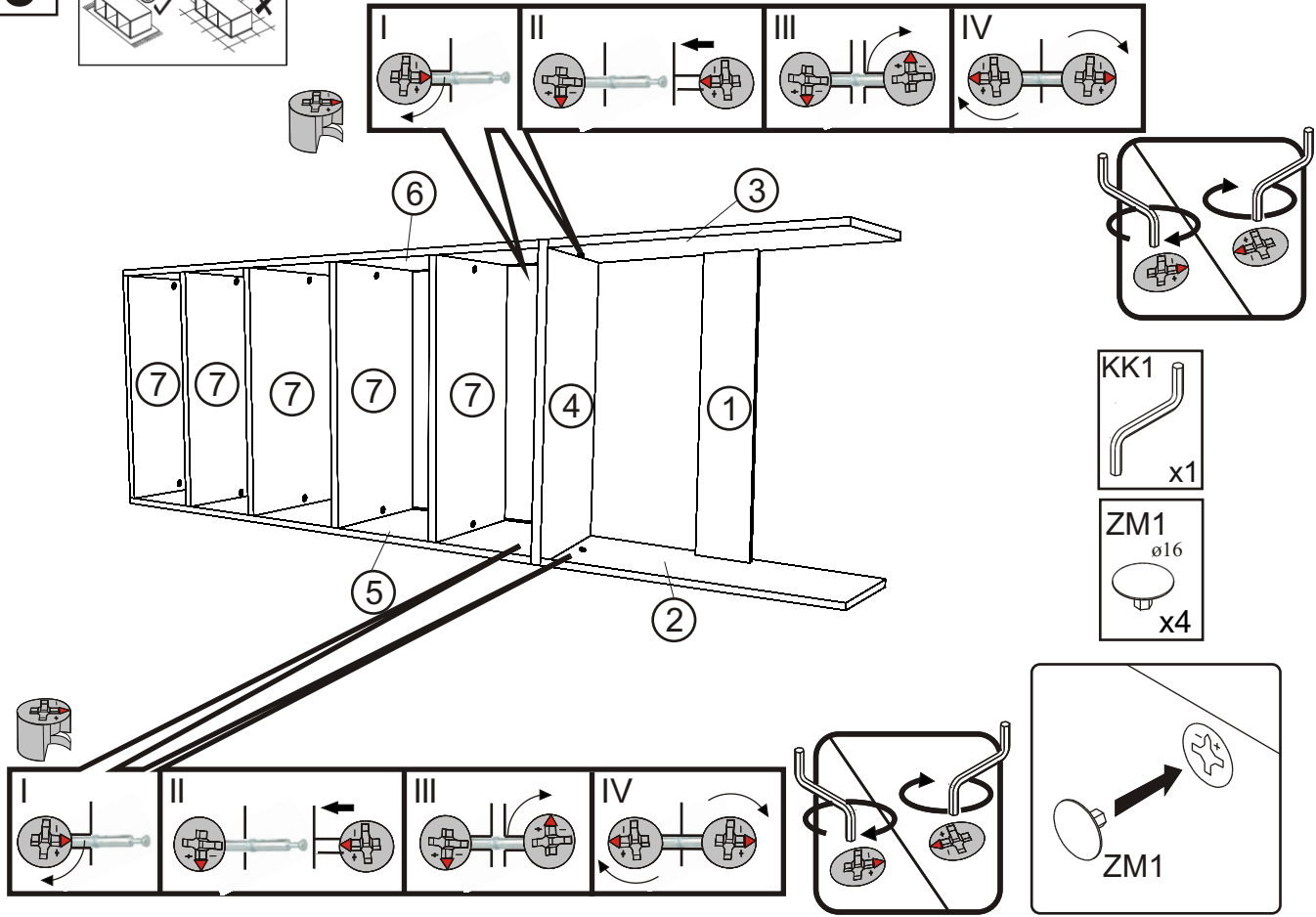
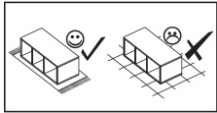

16

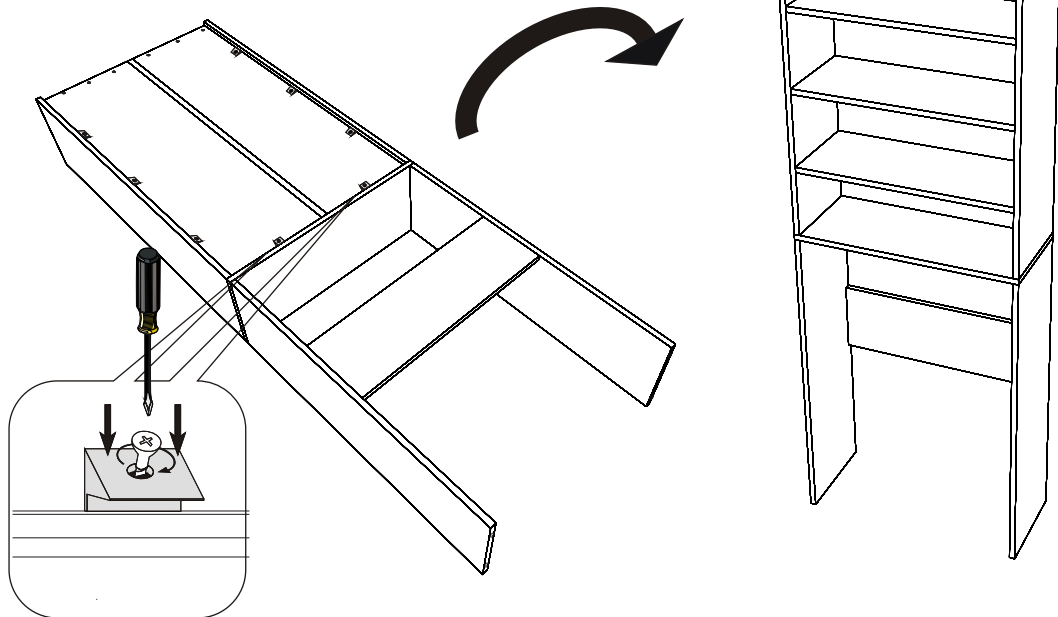
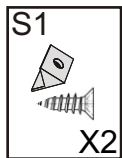
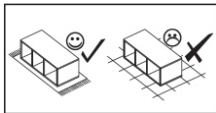

17

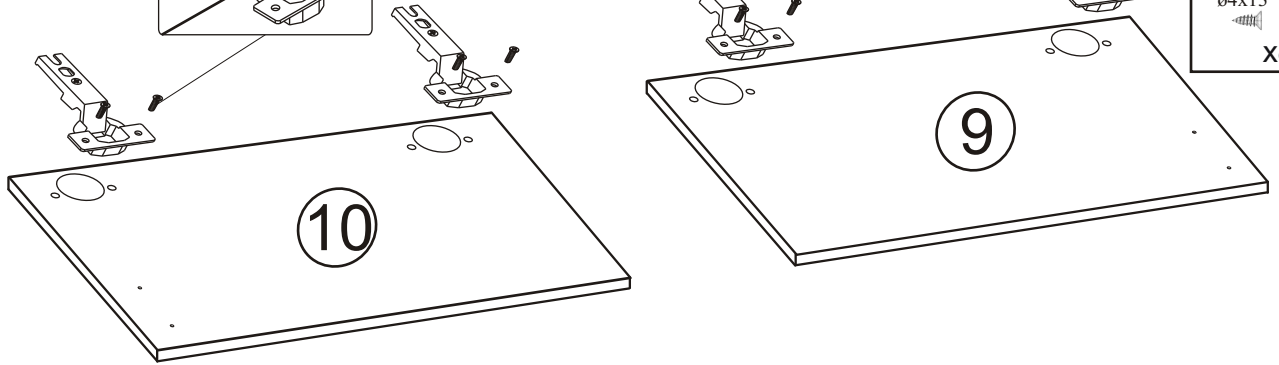
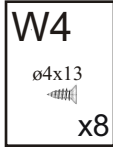
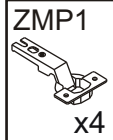
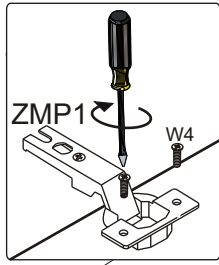
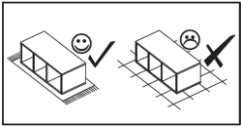

18

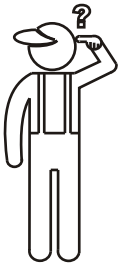

1/2/3 ?

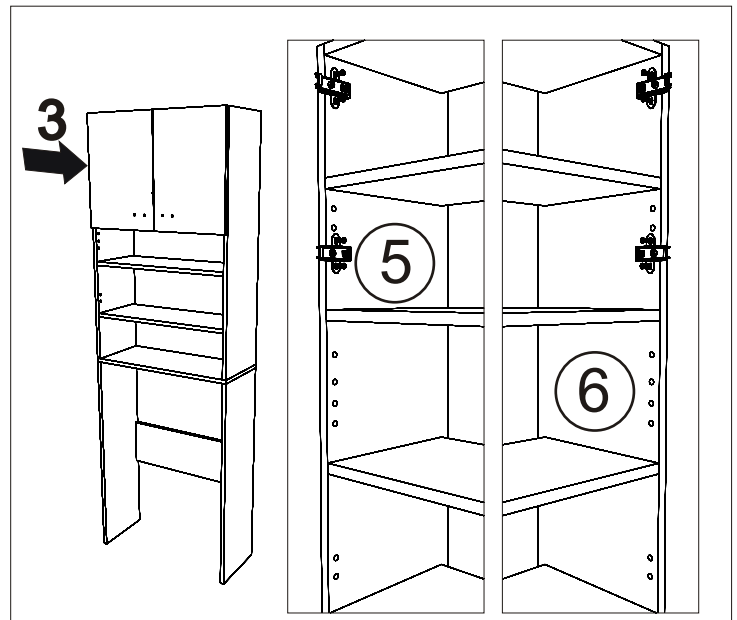
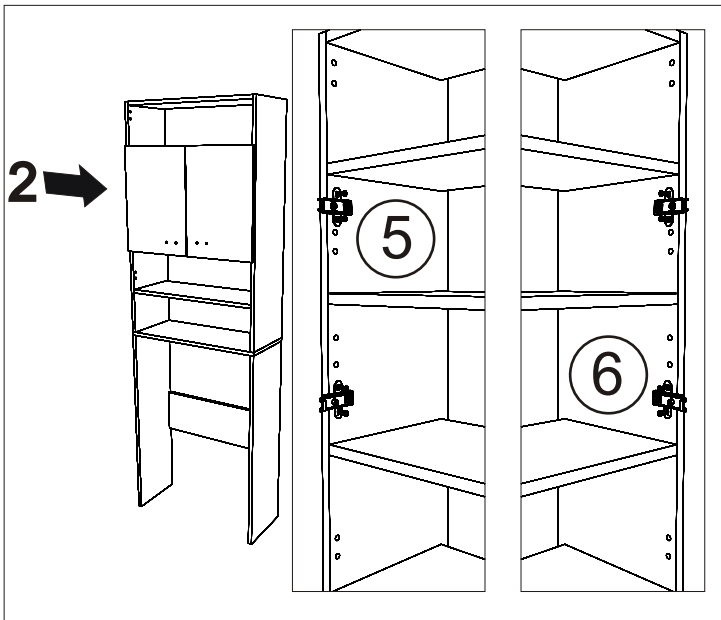
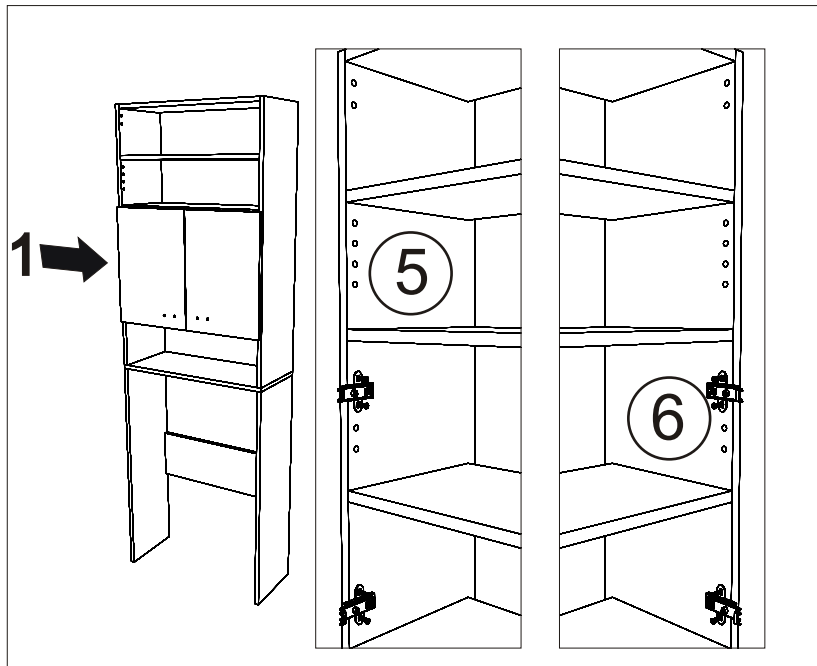
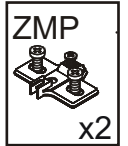
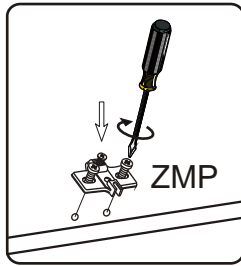

19

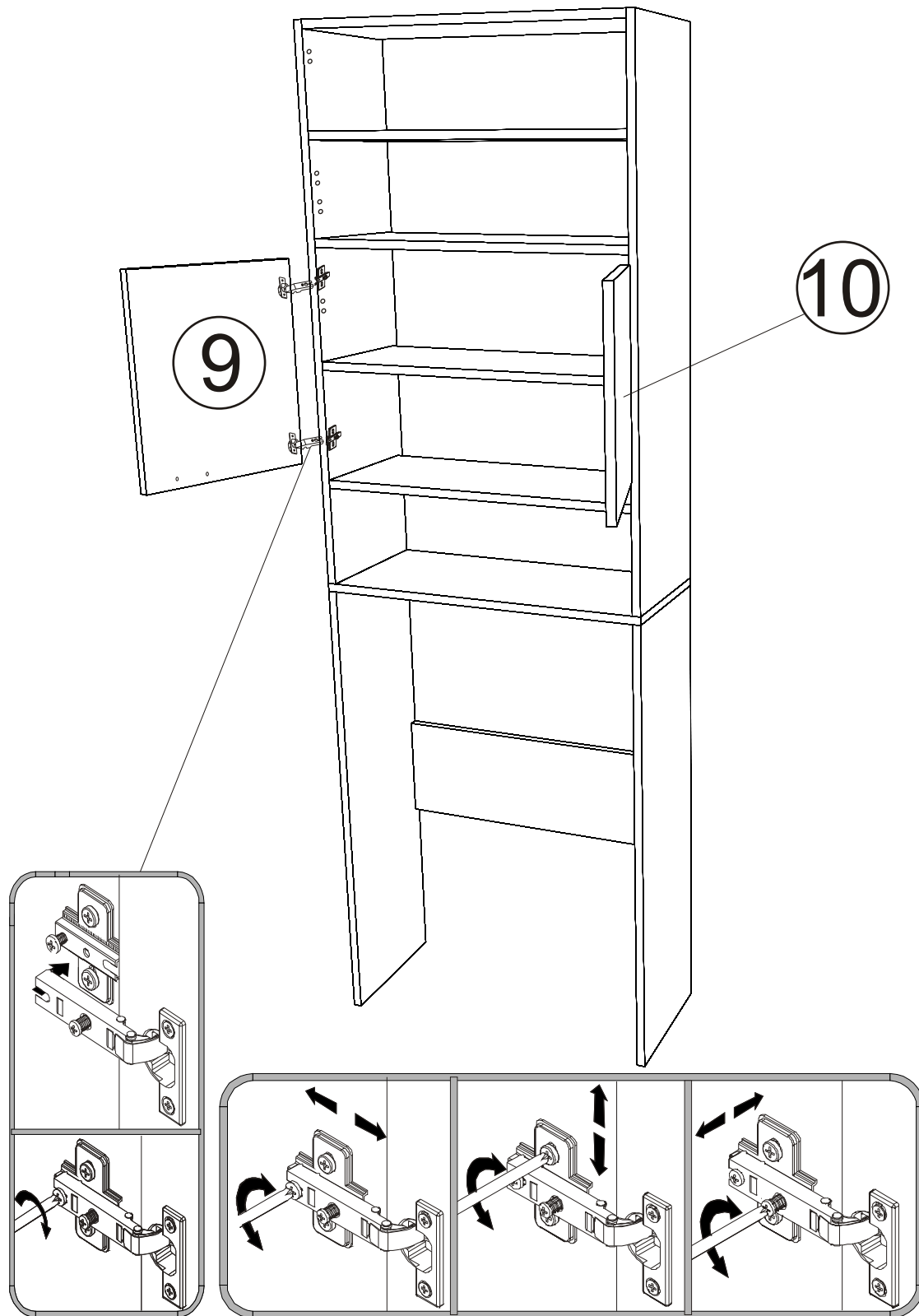

20

