

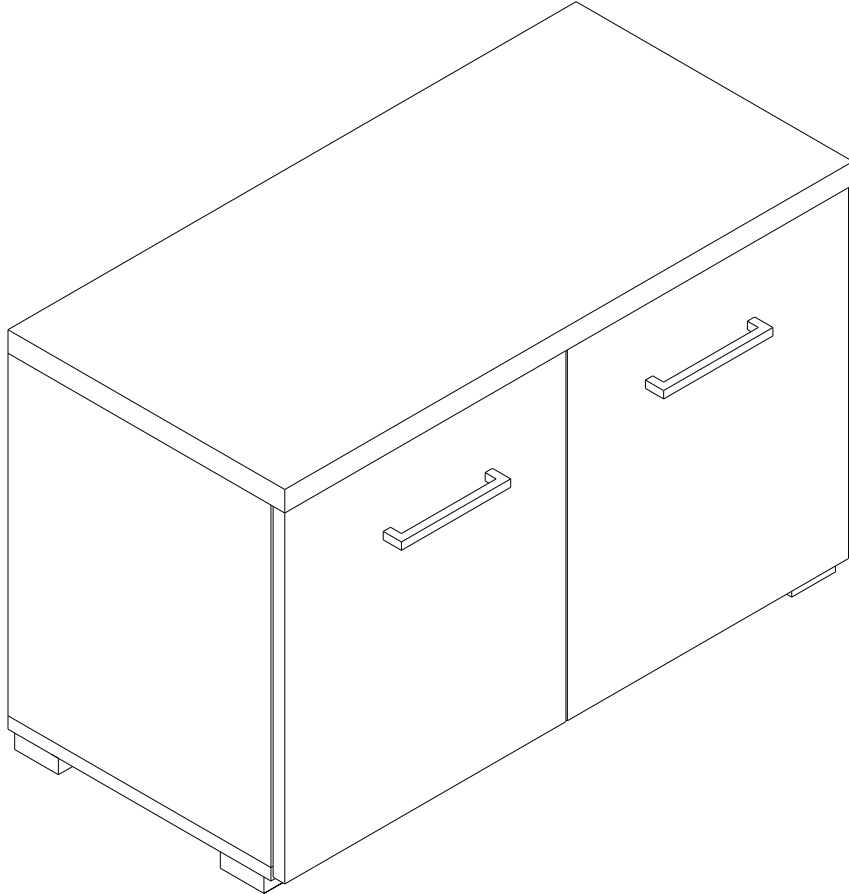

wyprodukowano dla / made for / produziert für
BEGA GRUPPE
producent: **MEBLE OKMED** POLAND

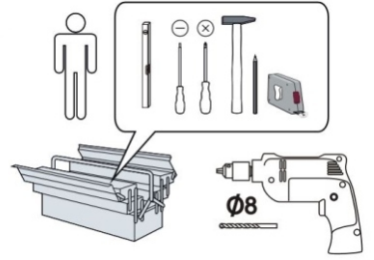

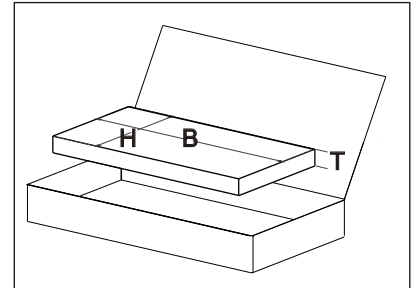
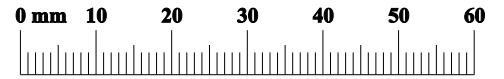
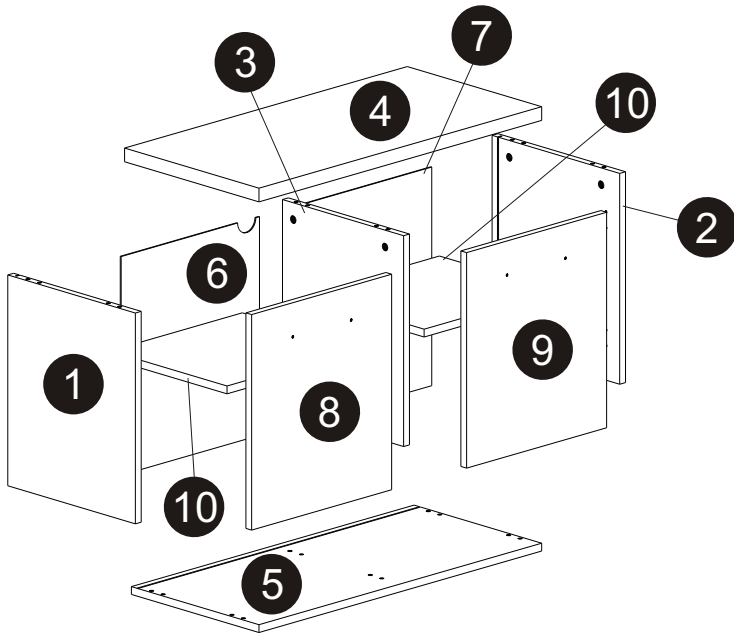

A 1/1

	B	H	T	
1	431	361	16	x1
2	431	361	16	x1
3	431	343	16	x1
4	780	380	28	x1
5	780	361	16	x1
6	447	382	3	x1
7	447	382	3	x1
8	441	386	16	x1
9	441	386	16	x1
10	365	333	16	x2

	1		6		6		6		6
	12		5		10		4		4
	4		4		8		8		8
	1		1		2		2		4

01

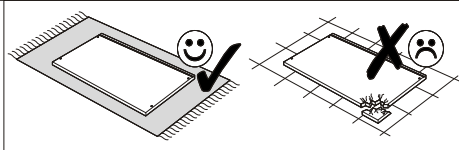

	6		2		4		4
--	---	--	---	--	---	--	---

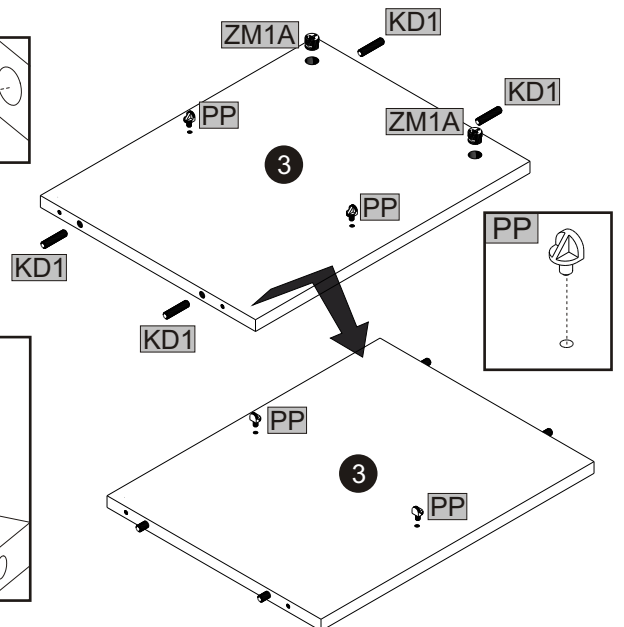
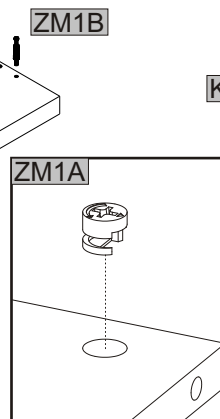
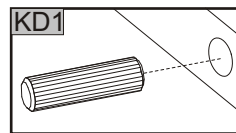
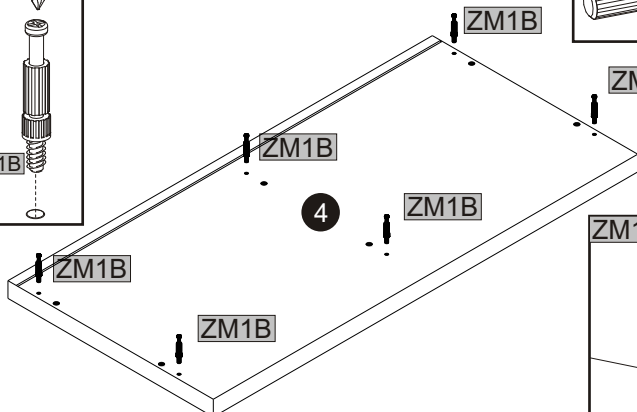
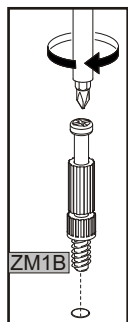

02

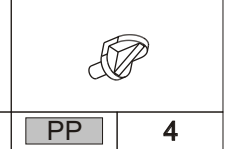
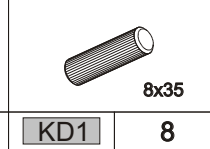
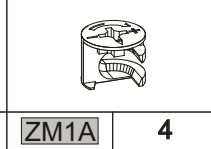
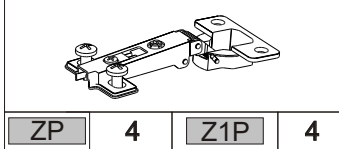
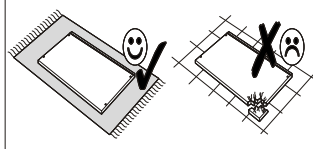

ZP	4	Z1P	4	ZM1A	4	KD1	8	PP	4
----	---	-----	---	------	---	-----	---	----	---

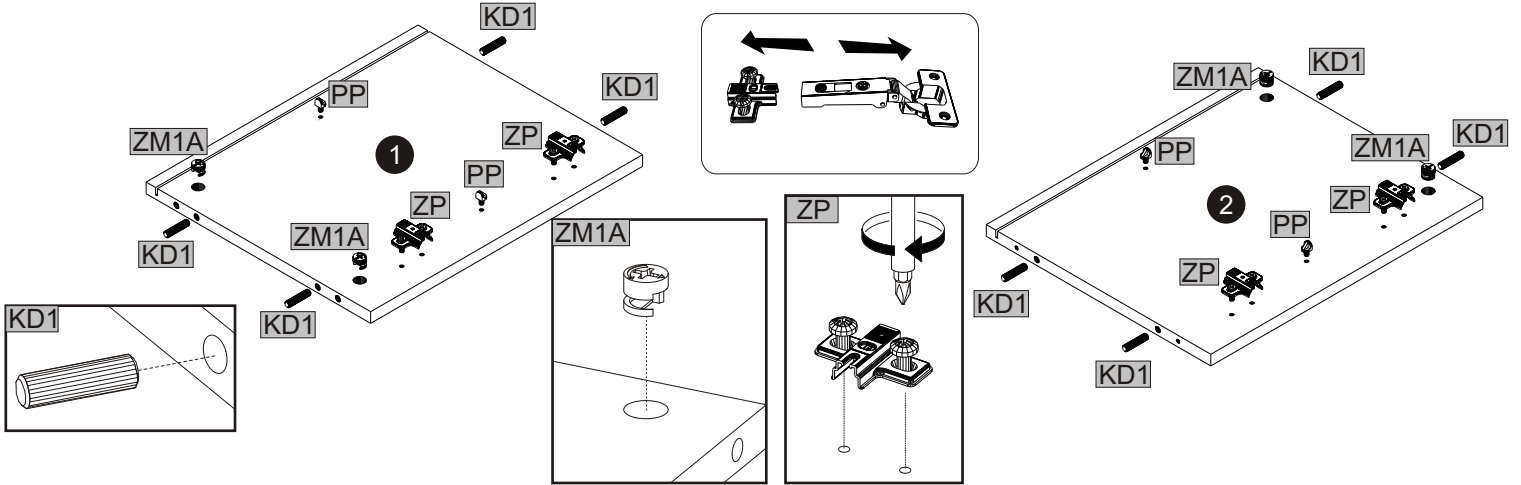

03

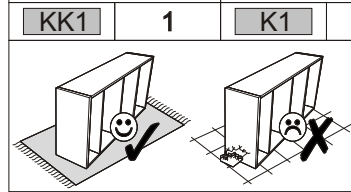
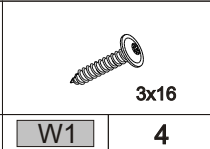
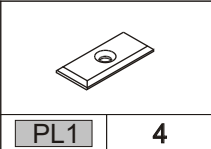
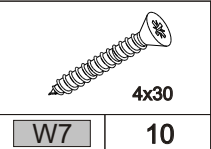
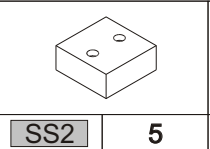
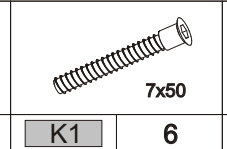
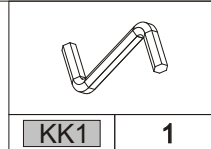

KK1	1	K1	6	SS2	5	W7	10	PL1	4	W1	4
-----	---	----	---	-----	---	----	----	-----	---	----	---

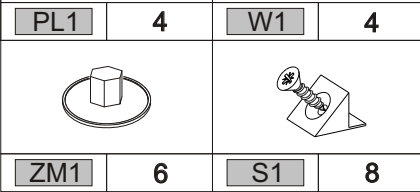

ZM1	6	S1	8
-----	---	----	---

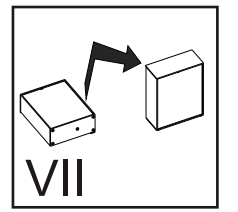
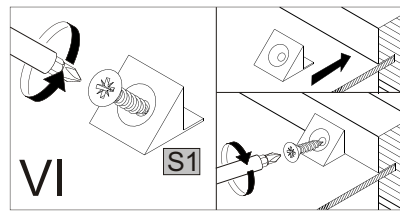
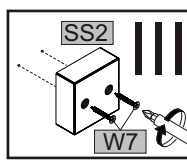
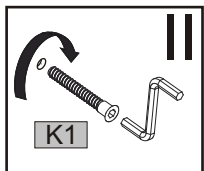
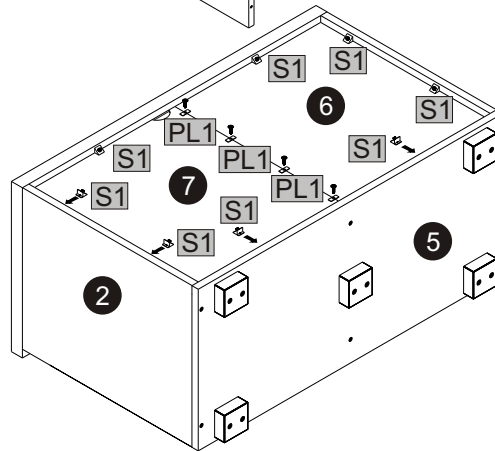
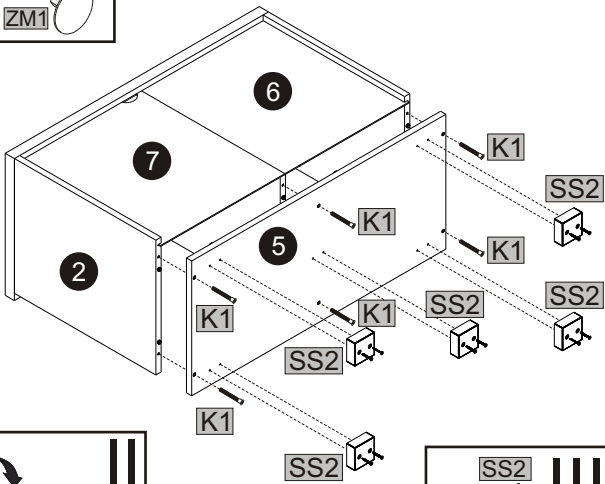
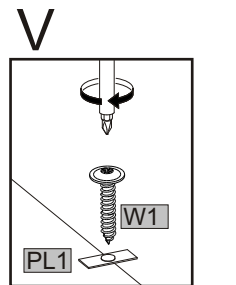
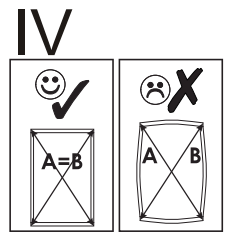
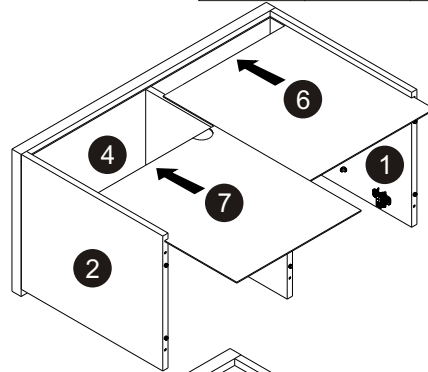
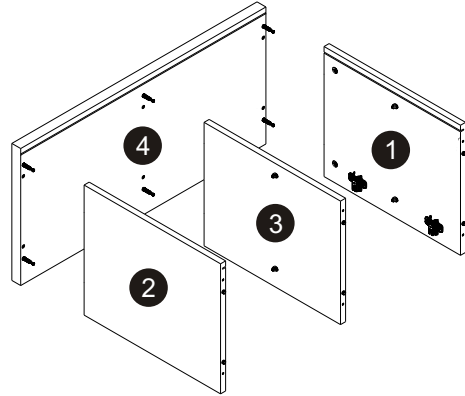
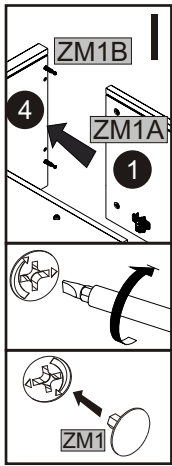

04

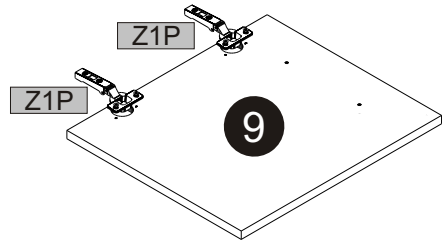
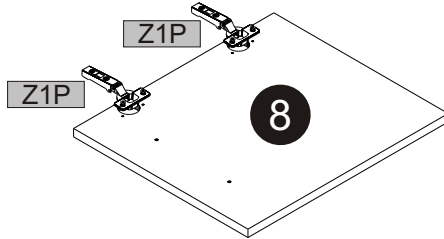
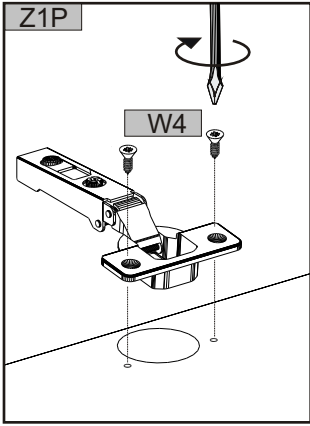
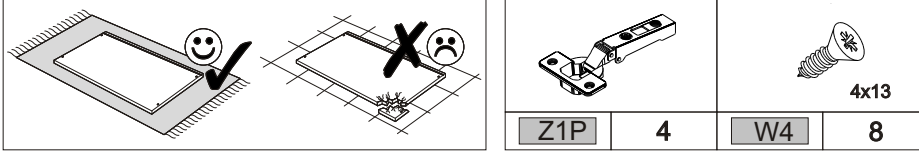

05

