

# BOBBY

# KOM 3D4S

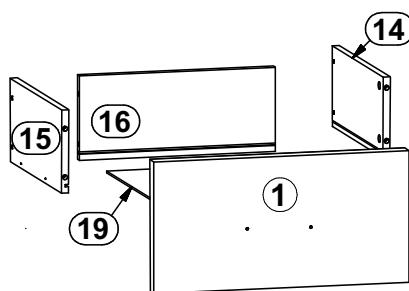

A	B	C	D	
1	N11-008	396	227	2 / 2
2	N11-004	782	396	2 / 2
3	N11-005	782	396	2 / 2
4	N11-007	396	160	2 / 2
5	N11-103	788	323	1 / 2
6	N11-107	788	323	1 / 2
7	N11-108	788	323	1 / 2
8	N11-205	1600	347	1 / 2
9	N11-206	1600	347	1 / 2
10	N11-304	775	323	1 / 2
11	N11-305	375	323	1 / 2
12	N11-502	300	115	1 / 2
13	N11-503	300	115	1 / 2
14	N11-504	300	160	1 / 2
15	N11-505	300	160	1 / 2
16	N11-506	327	160	1 / 2
17	N11-507	327	115	1 / 2
18	N11-903	814	398	1 / 2
19	N11-905	341	297	1 / 2
20	lh-784	784	14	1 / 2

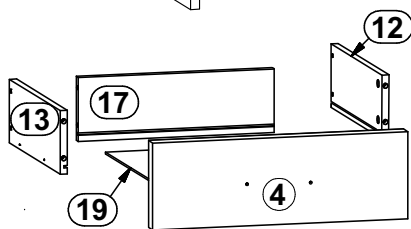
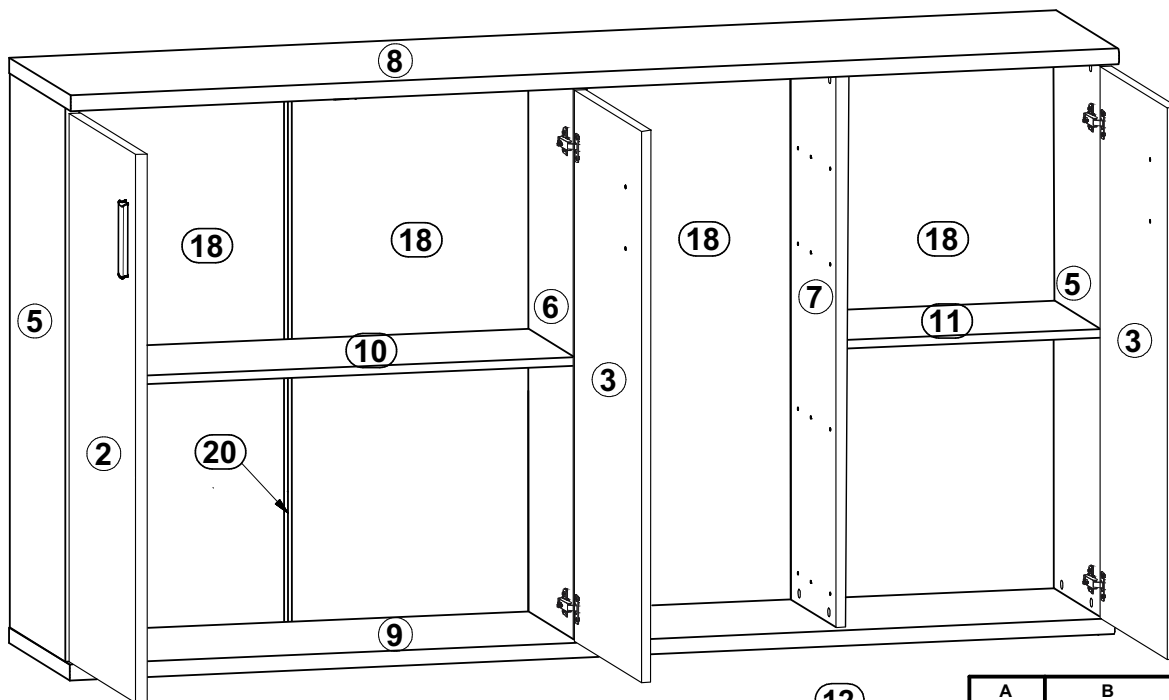
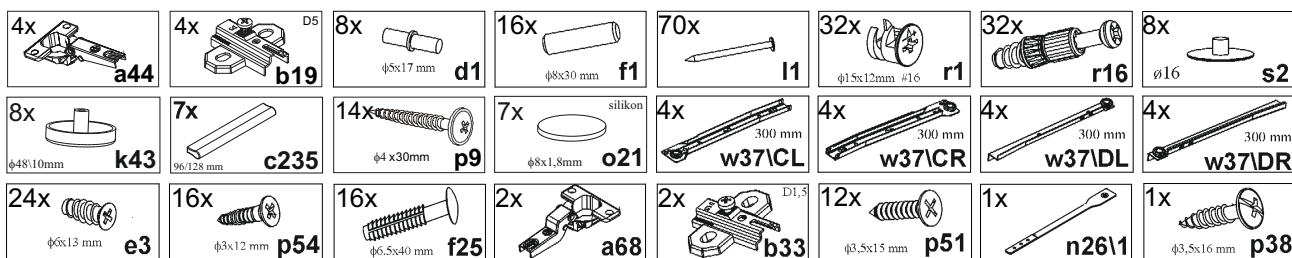
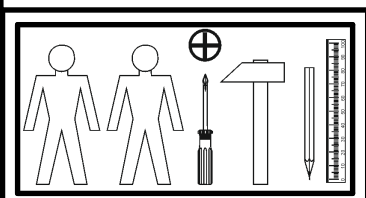

# 1

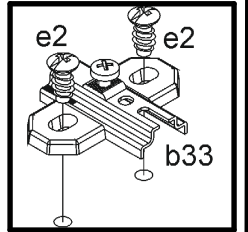
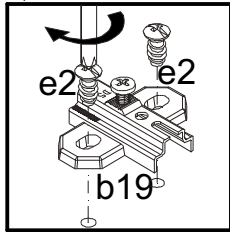
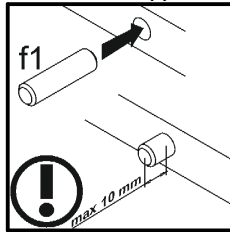
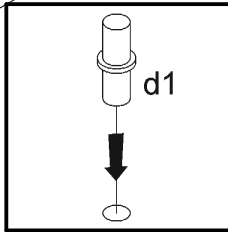
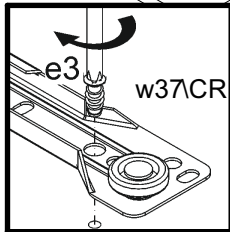
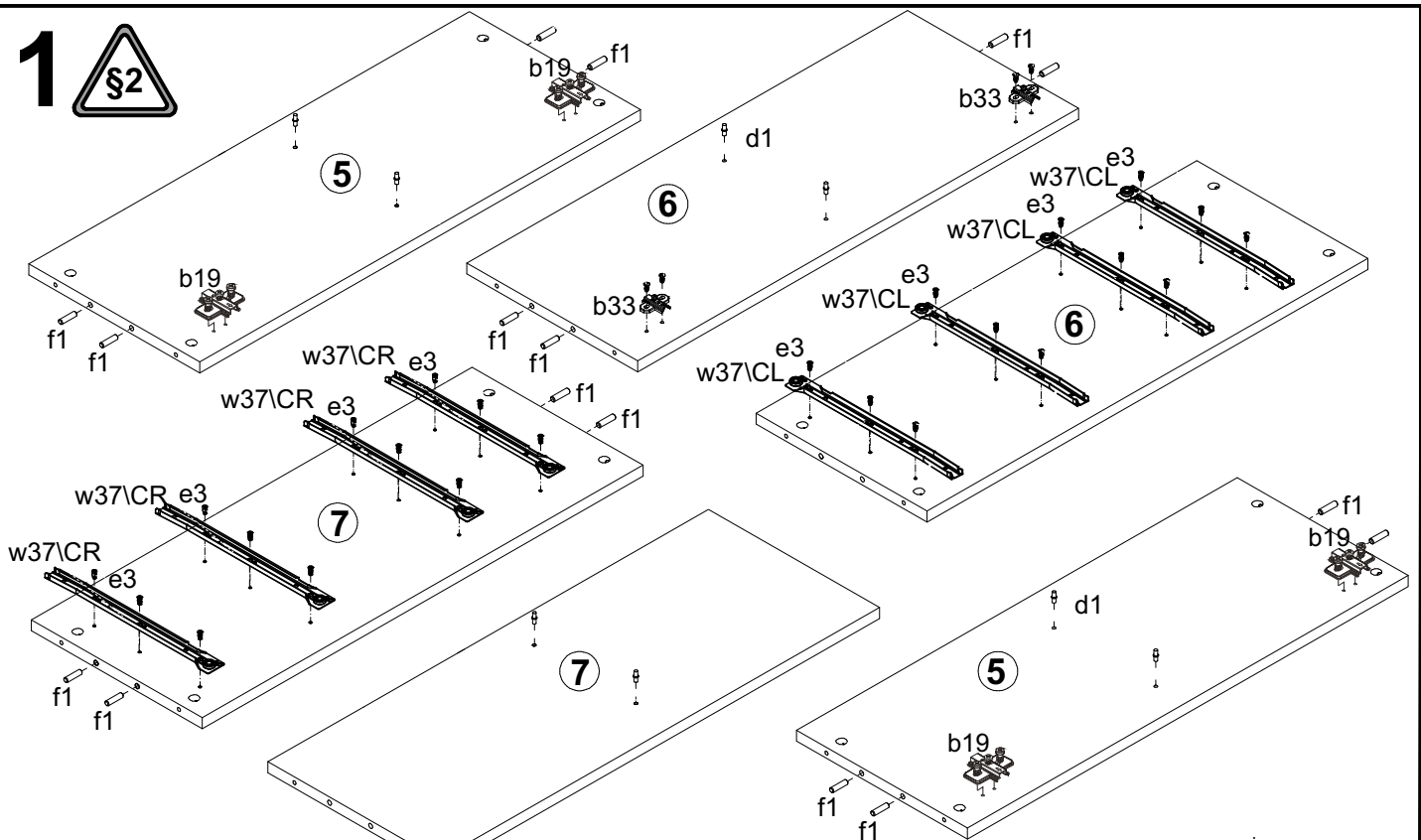

# 2

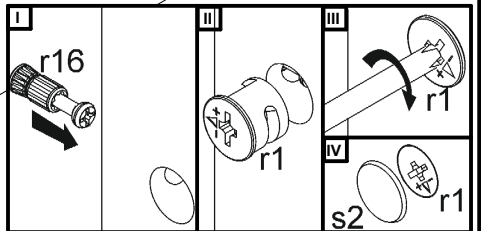
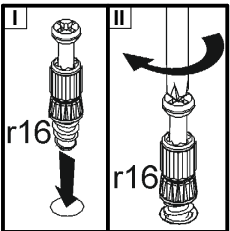
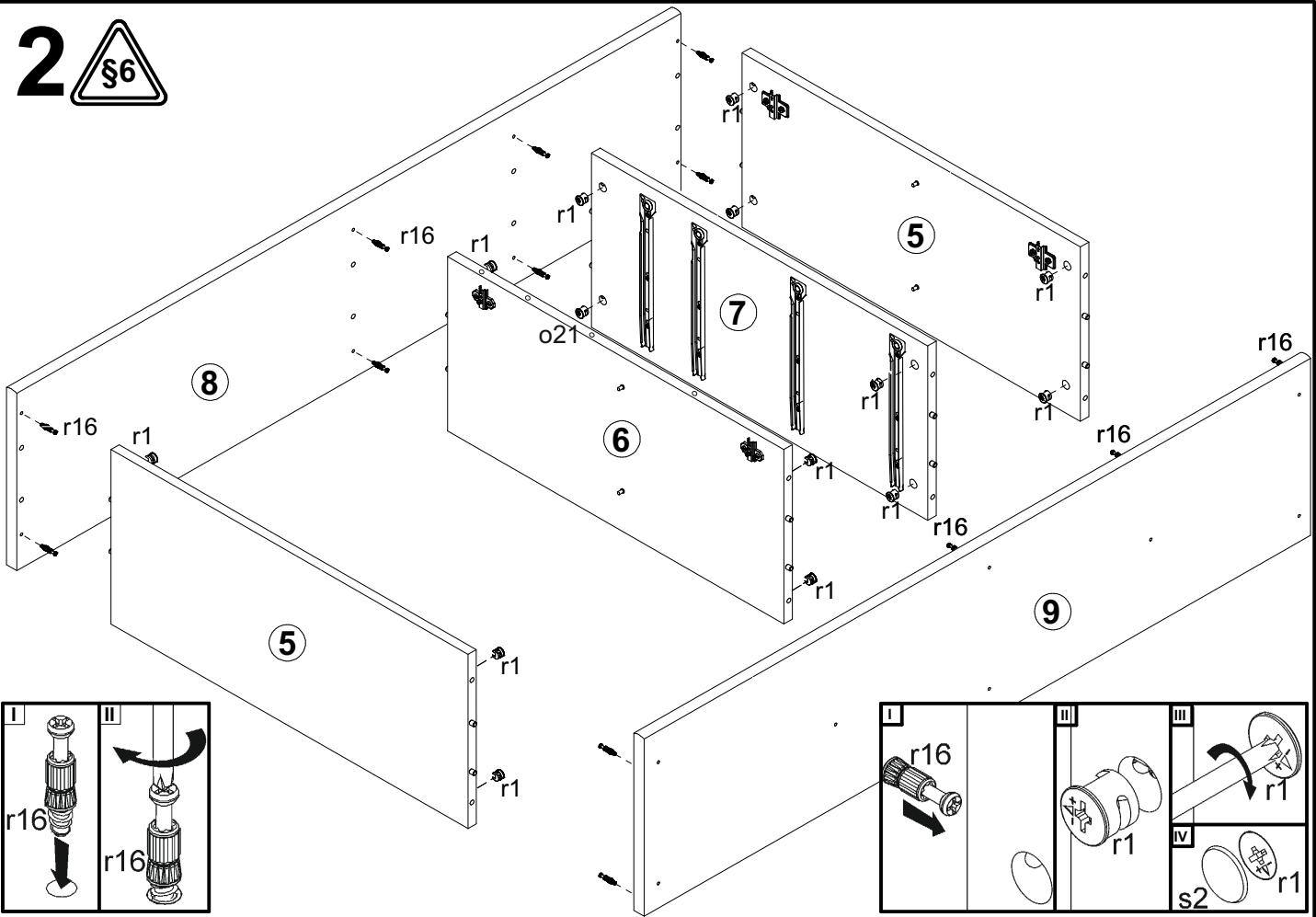

# 3

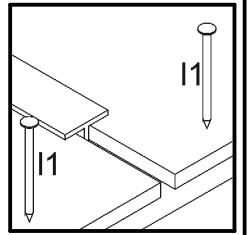
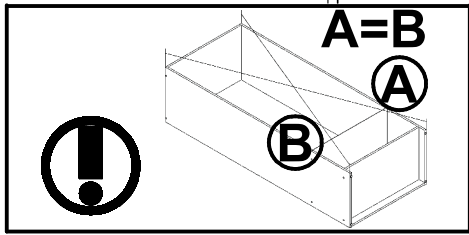
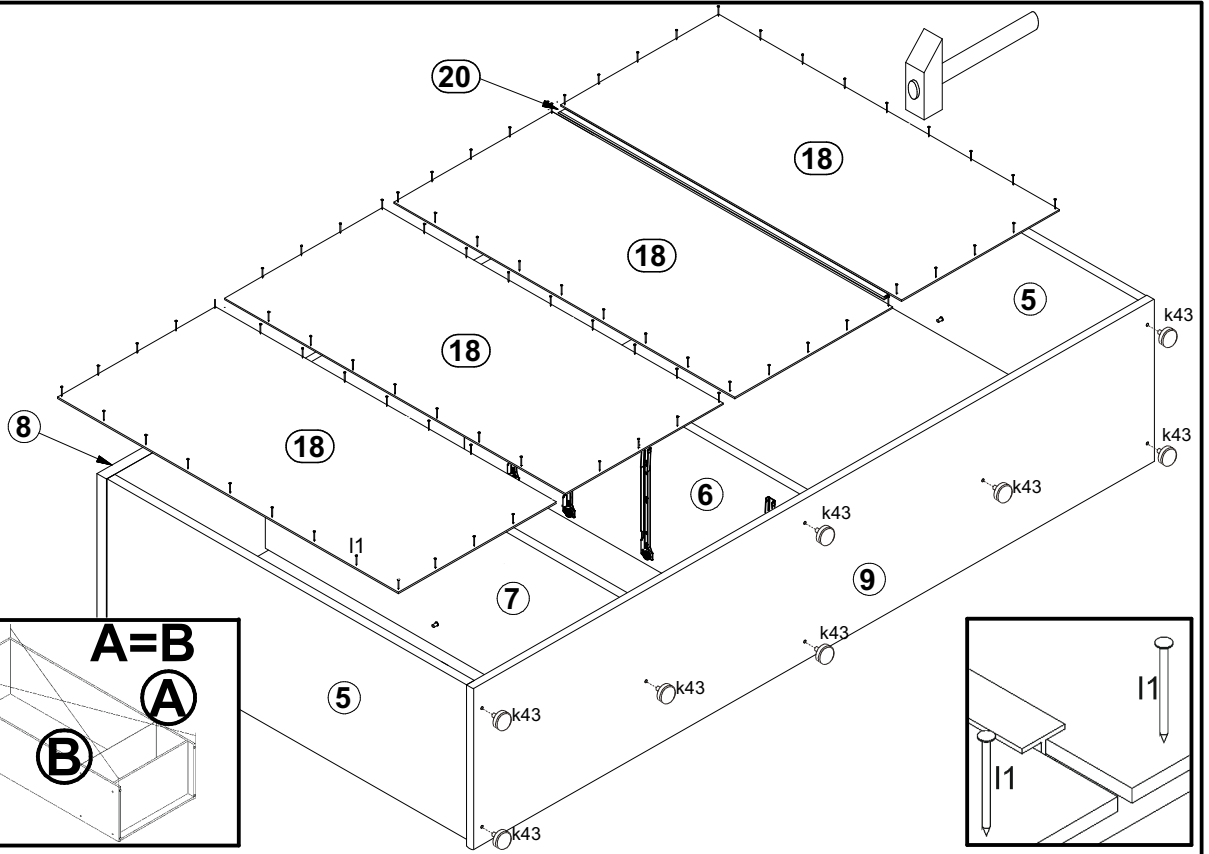

# 4

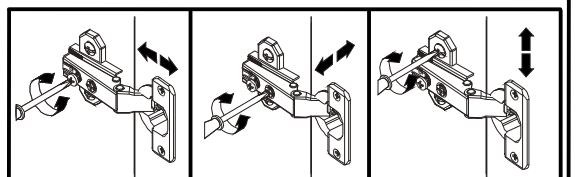
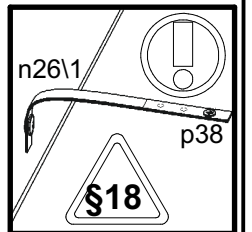
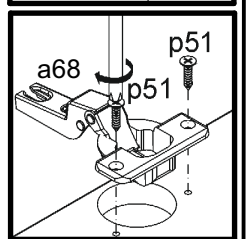
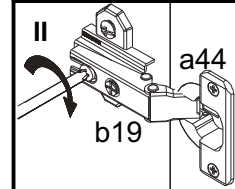
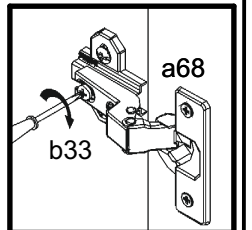
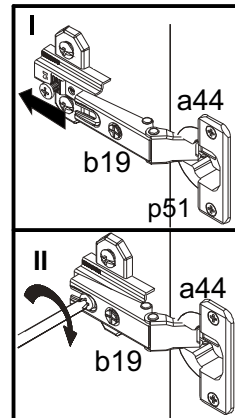
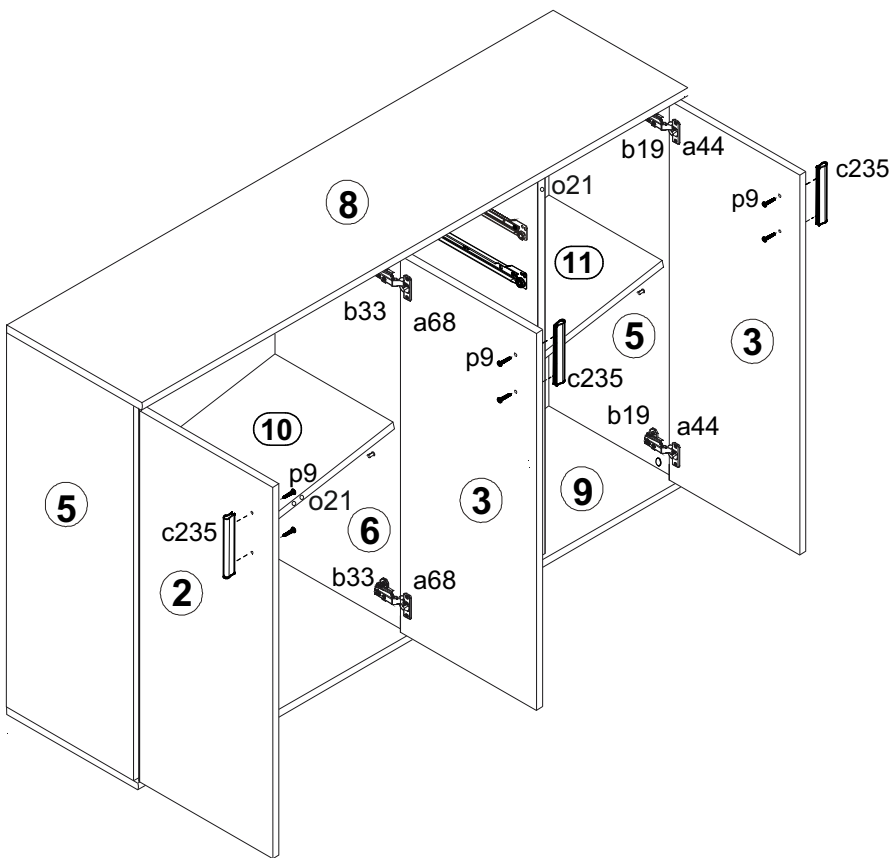

# 5

