

A**S288-NAD/2/15**

2 / 5

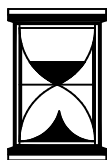

20 min

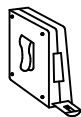
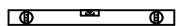
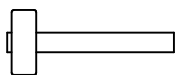
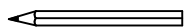
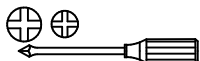
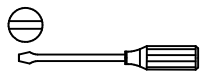
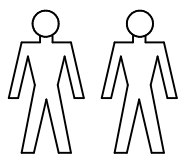
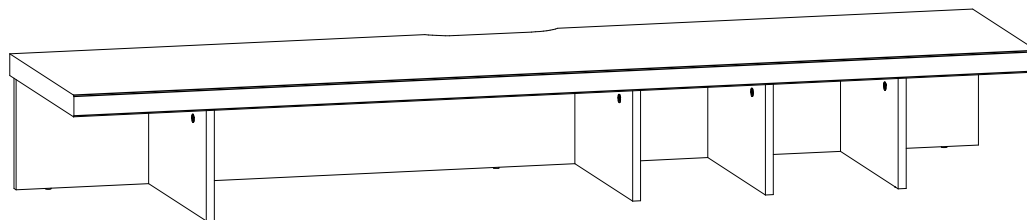

A	B	C (mm)		D
1	S288-1013	163	324	3/6
2	S288-2007	1450	360	3/6
3	S288-4003	163	1449	3/6

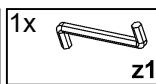
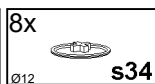
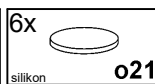
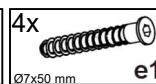
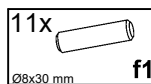
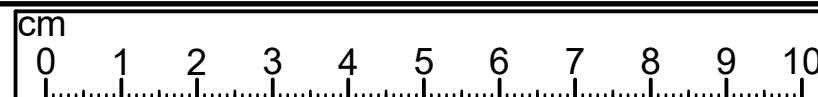
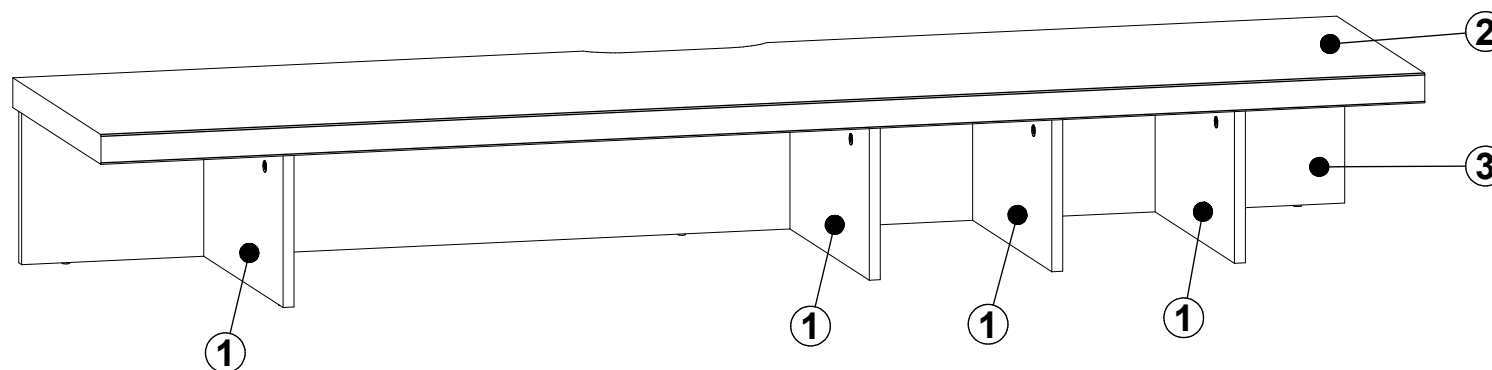

1

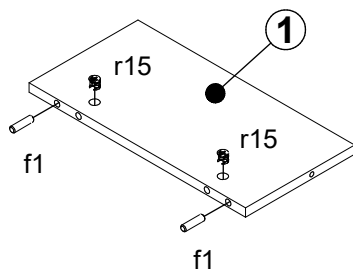
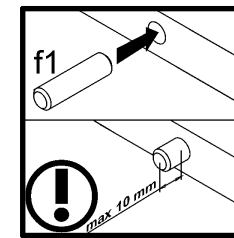
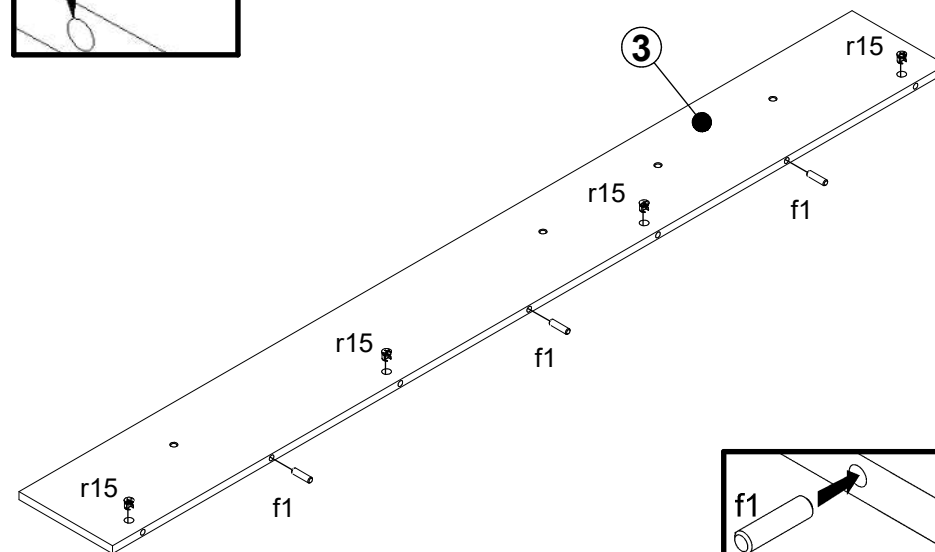
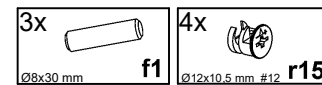
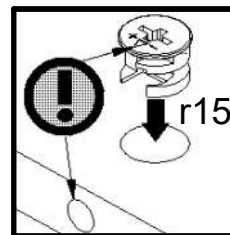
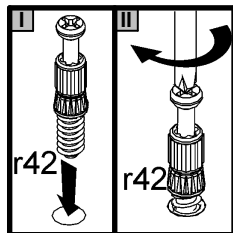
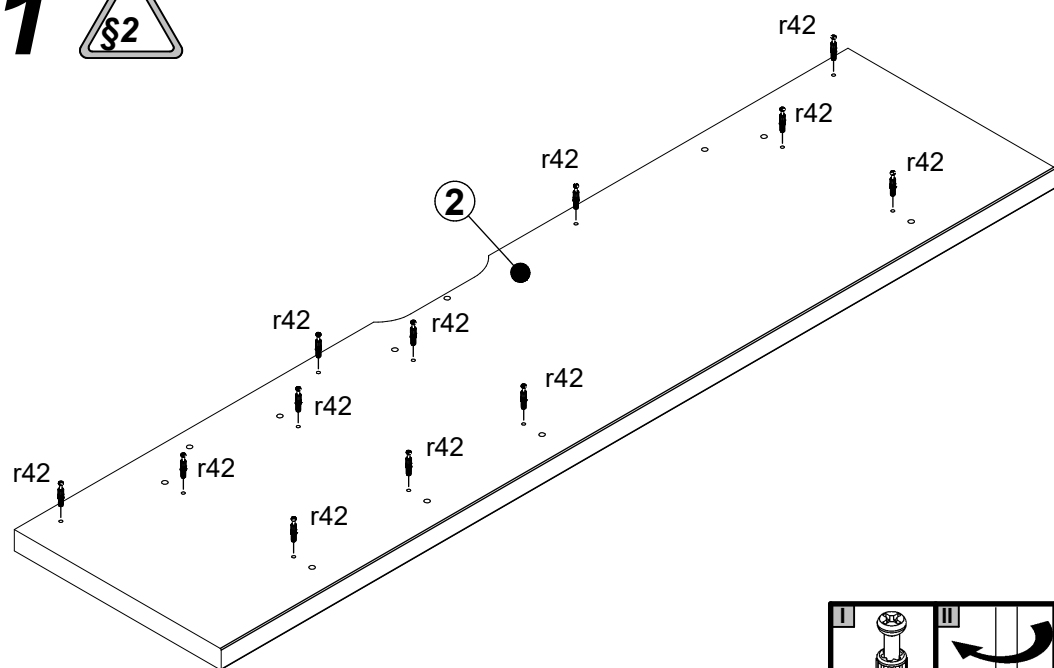

x4

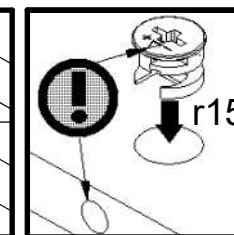
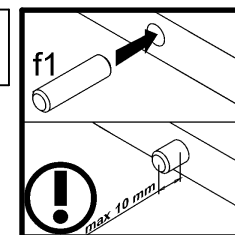
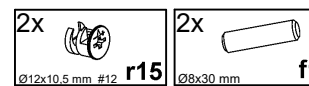

2

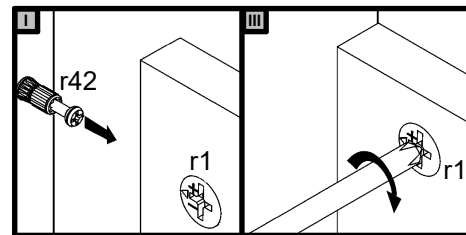
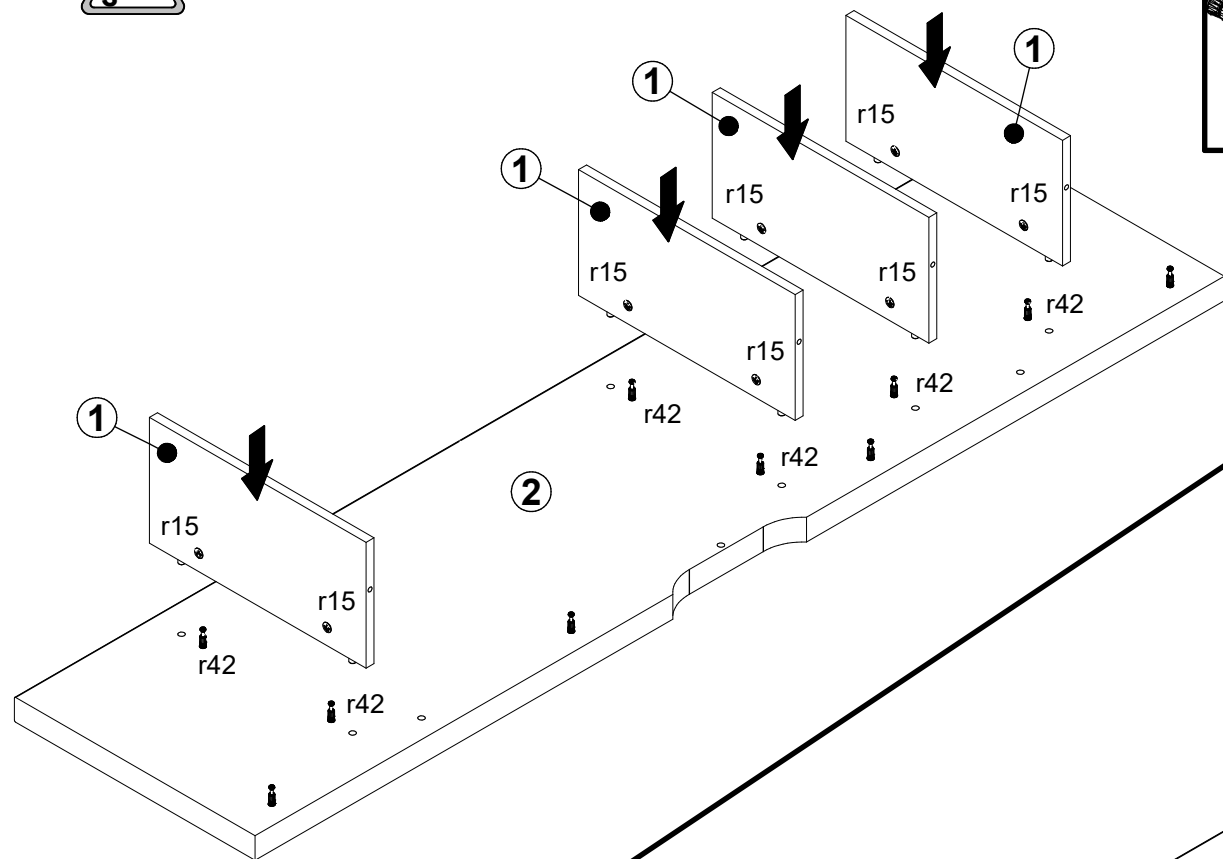

3

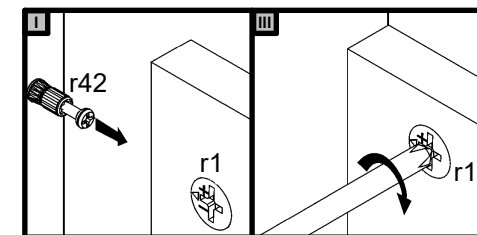
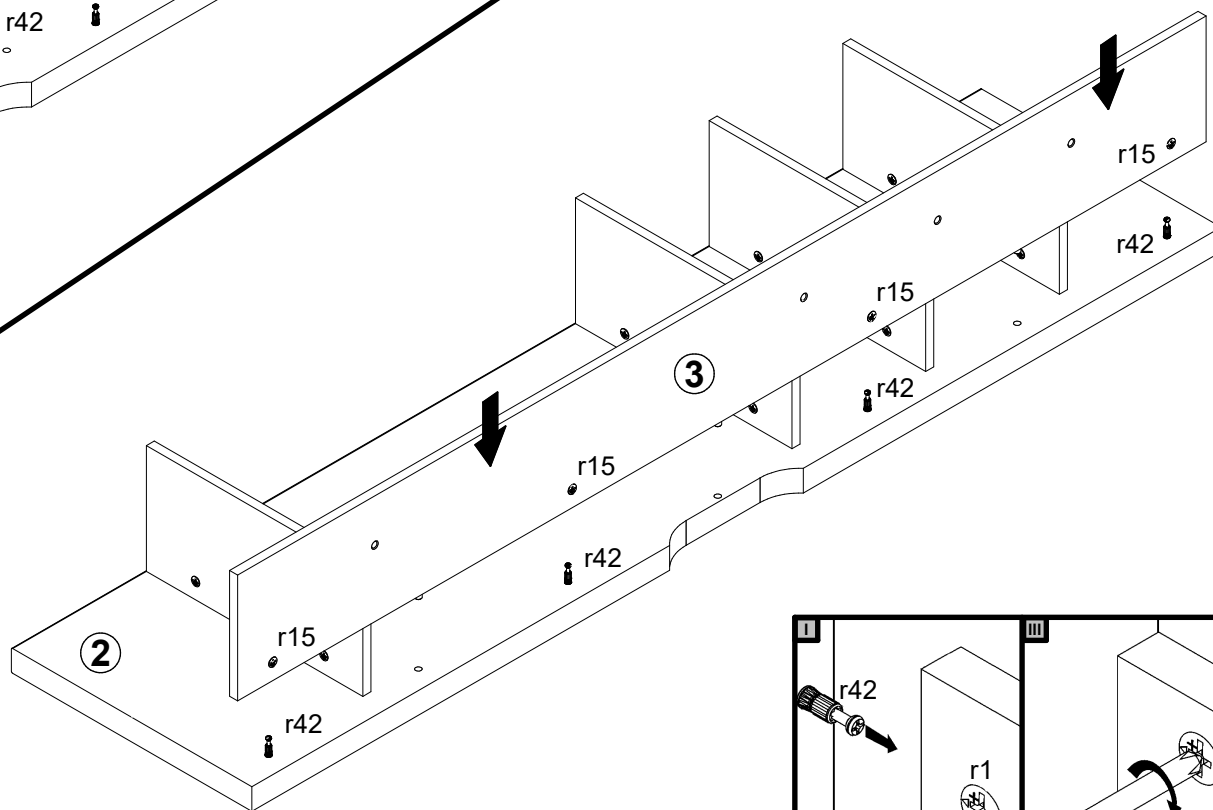

4

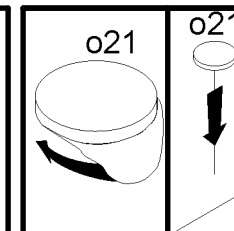
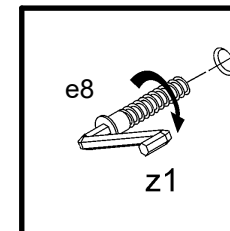
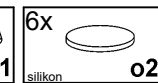
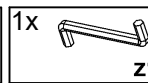
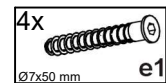
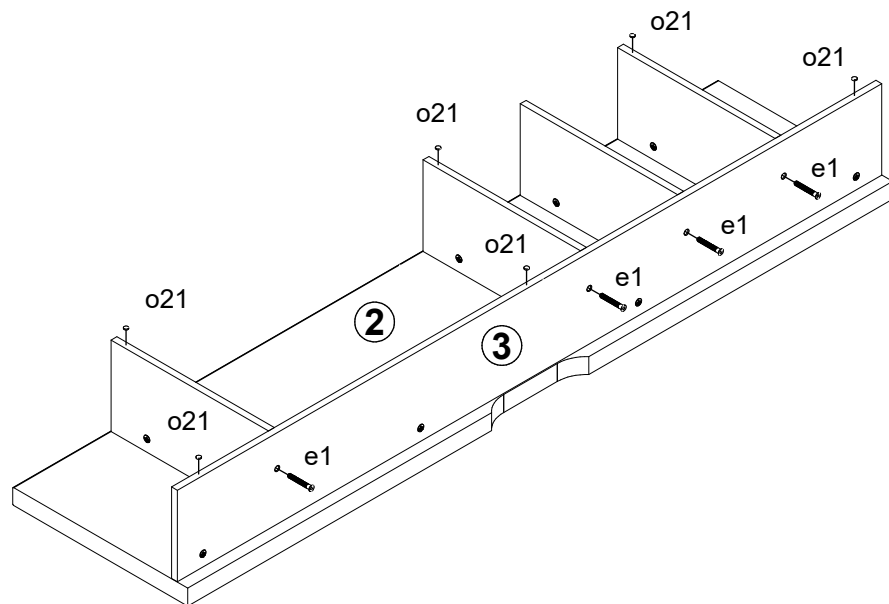

5

